

A

ZELE

M234

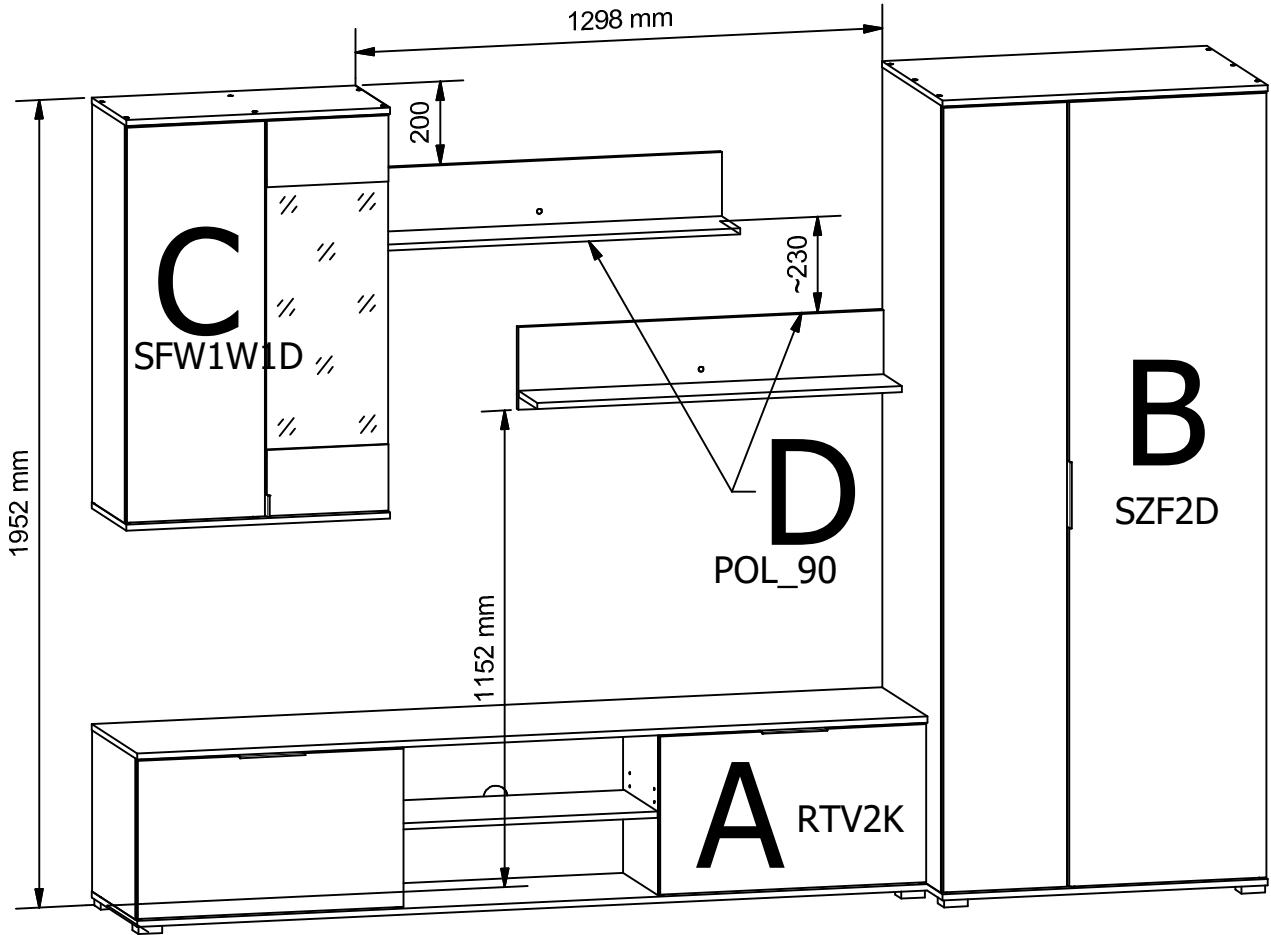

A	4x a43	4x b19	2x c409 128mm	12x d1 Ø5x17 mm	8x e1 Ø7x50 mm	12x e3 Ø6x13 mm	12x f1 Ø8x30 mm	6x k82\1 Ø51 mm
	6x k82\2 58x58x18 mm	8x l2	4x m56\5 60N	4x m57\1	4x m57\3	6x n108 22x9.5x20.7 mm	4x o2 silikon	20x p5 Ø3.5x13 mm
	8x p51 Ø3.5x15 mm	6x p55 Ø2.9x16 mm	4x p93 Ø4x13 mm	8x r1 Ø15x12 mm #16	8x r42 20/11	8x s2 Ø16	1x z1 4 mm	1x n26\1
								1x p38 Ø3.5x16 mm
B	7x a44	7x b19	1x c409 128mm	1x d5 Ø6.3x15 mm	12x e1 Ø7x50 mm	8x e3 Ø6x13 mm	12x f1 Ø8x30 mm	1x f35 Ø10x50 mm
	4x k82\1 Ø51 mm	4x k82\2 58x58x18 mm	60x l1 1.4x20 mm	2x n1 h=22mm	1x n14\2 86x21x15\1.5	2x o21 silikon	2x p1 Ø3.5x13 mm	1x p17 Ø5x60 mm
	2x p38 Ø3.5x16 mm	14x p51 Ø3.5x15 mm	2x p93 Ø4x13 mm	6x r1 Ø15x12 mm #16	6x r42 20/11	6x s2 Ø16	1x z1 4 mm	
C	4x a44	4x b19	1x c332 32 mm	16x d1 Ø5x17 mm	8x d3 Ø5x17 mm	12x e1 Ø7x50 mm	12x f1 Ø8x30 mm	1x f28 Ø8x40 mm
	2x f35 Ø10x50 mm	10x l2	5x n108 22x9.5x20.7 mm	1x n165\L	1x n165\P	1x n211 30x15x16\2	4x o21 silikon	4x p21 Ø4x30 mm
	5x p55 Ø2.9x16 mm	1x p74 Ø5x45 mm	3x p93 Ø4x13 mm	2x p127 Ø6x60 mm	12x s1	1x s68 Ø 20mm	1x z1 4 mm	1x n26\1
								1x p38 Ø3.5x16 mm
D	6x e1 Ø7x50 mm	8x e4 Ø5x11 mm	8x f1 Ø8x30 mm	4x f35 Ø10x50 mm	2x f50 Ø6x30 mm	4x g2	2x p62 Ø4x45 mm	4x p75 Ø6x60 mm
	2x s59 Ø14x0.5 mm	4x s60 silikon						

A	B	C	D	
1	M234-0003	655	382	2/4
2	M234-1003	390	400	1/4
3	M234-1004	390	400	1/4
4	M234-1005	390	320	1/4
5	M234-1006	390	320	1/4
6	M234-2003	1948	418	2/4
7	M234-2004	1948	418	2/4
8	M234-3003	628	307	1/4
9	M234-3004	628	274	1/4
10	M234-9001	644	400	2/4
11	M234-9004	641	400	2/4



A

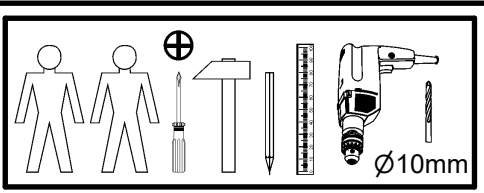
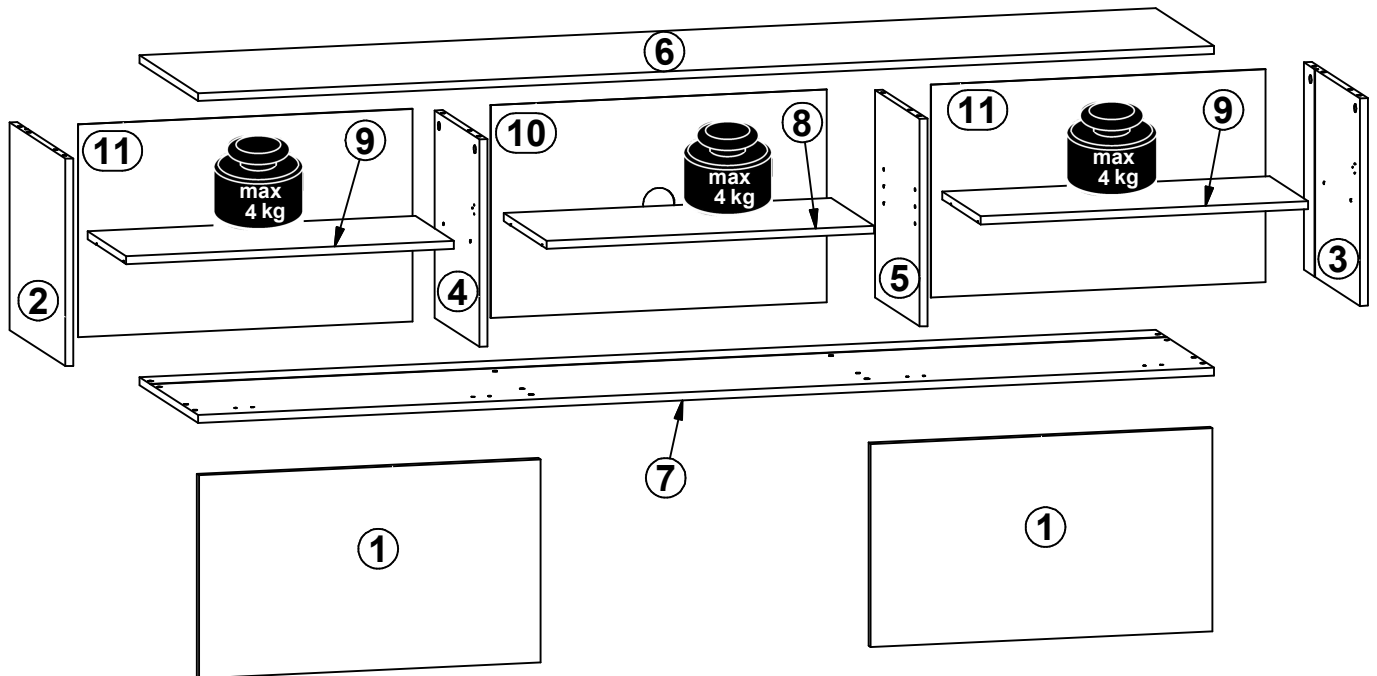
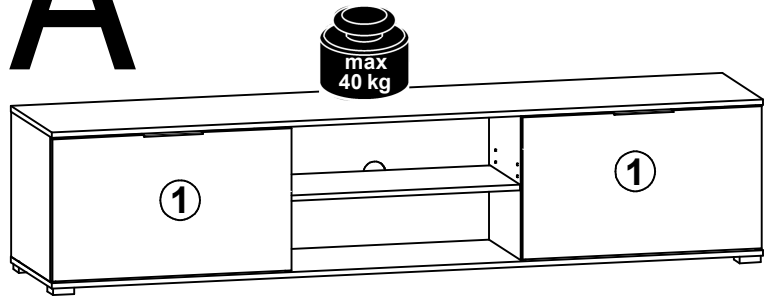

4x K16 a43	4x b19	2x 128mm c409	12x Ø5x17 mm d1	8x Ø7x50 mm e1	12x Ø6x13 mm e3	12x Ø8x30 mm f1	6x Ø51 mm k82/1	6x 58x58x18 mm k82/2
8x I2	4x Ø8x m56/5	4x m57/1	4x m57/3	6x 22x9,5x2/0,7 mm n108	4x silikon o21	20x Ø3,5x13 mm p5	8x Ø3,5x15 mm p51	6x Ø2,9x16 mm p55
4x Ø4x13 mm p93	8x Ø15x12 mm #16 r1	8x 20/11 r42	8x Ø16 s2	1x 4 mm z1	1x n26/1	1x Ø3,5x16 mm p38		

1 

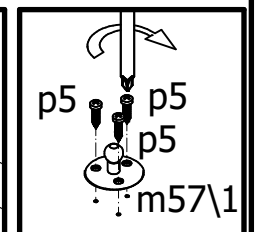
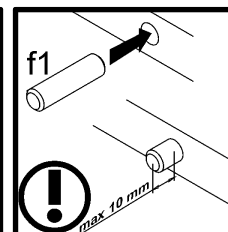
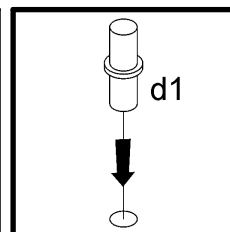
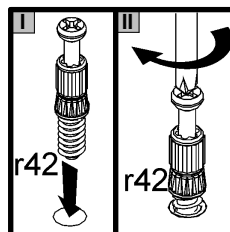
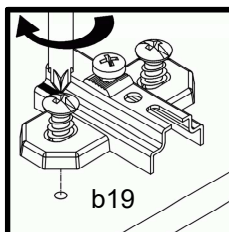
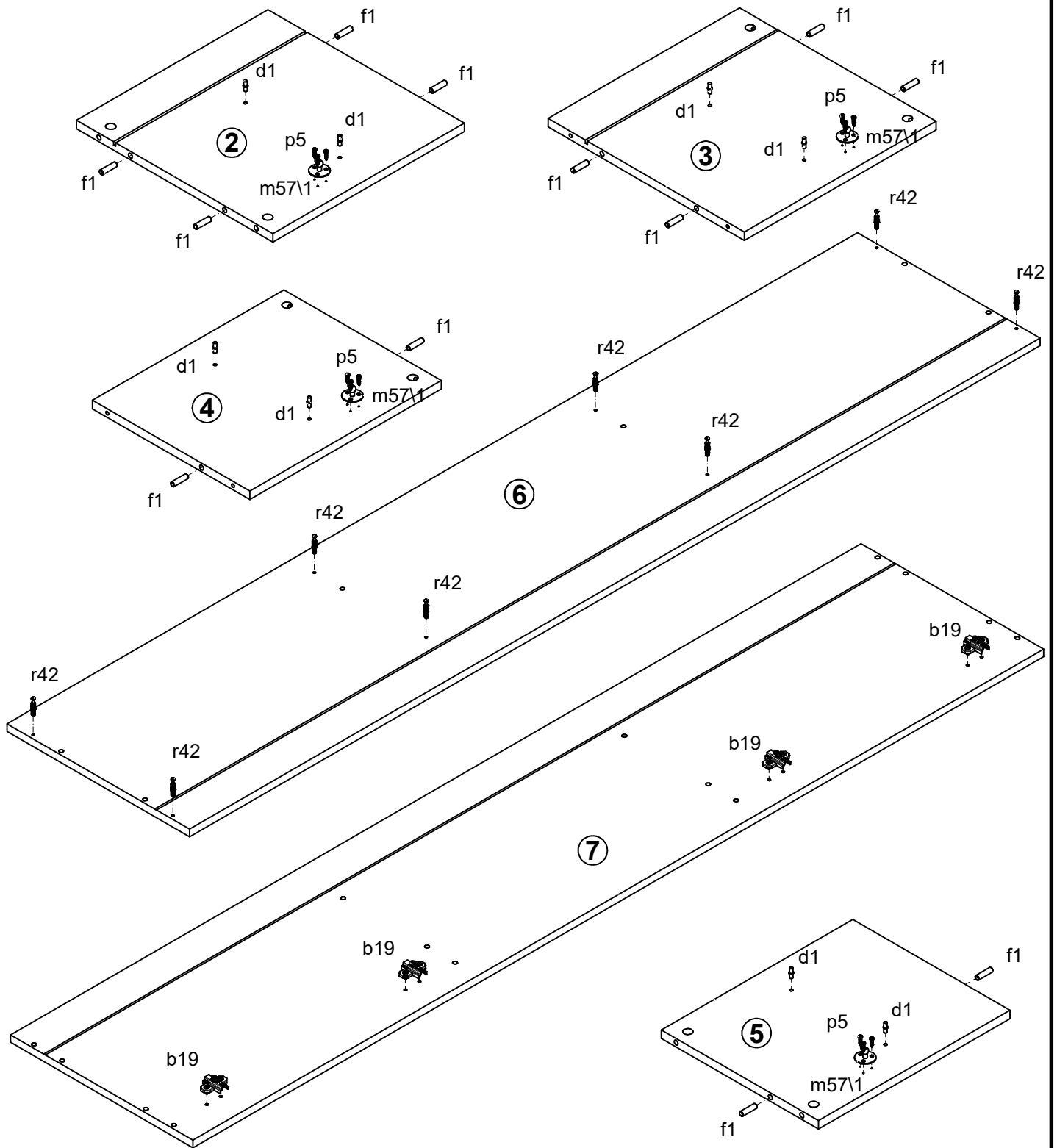

2

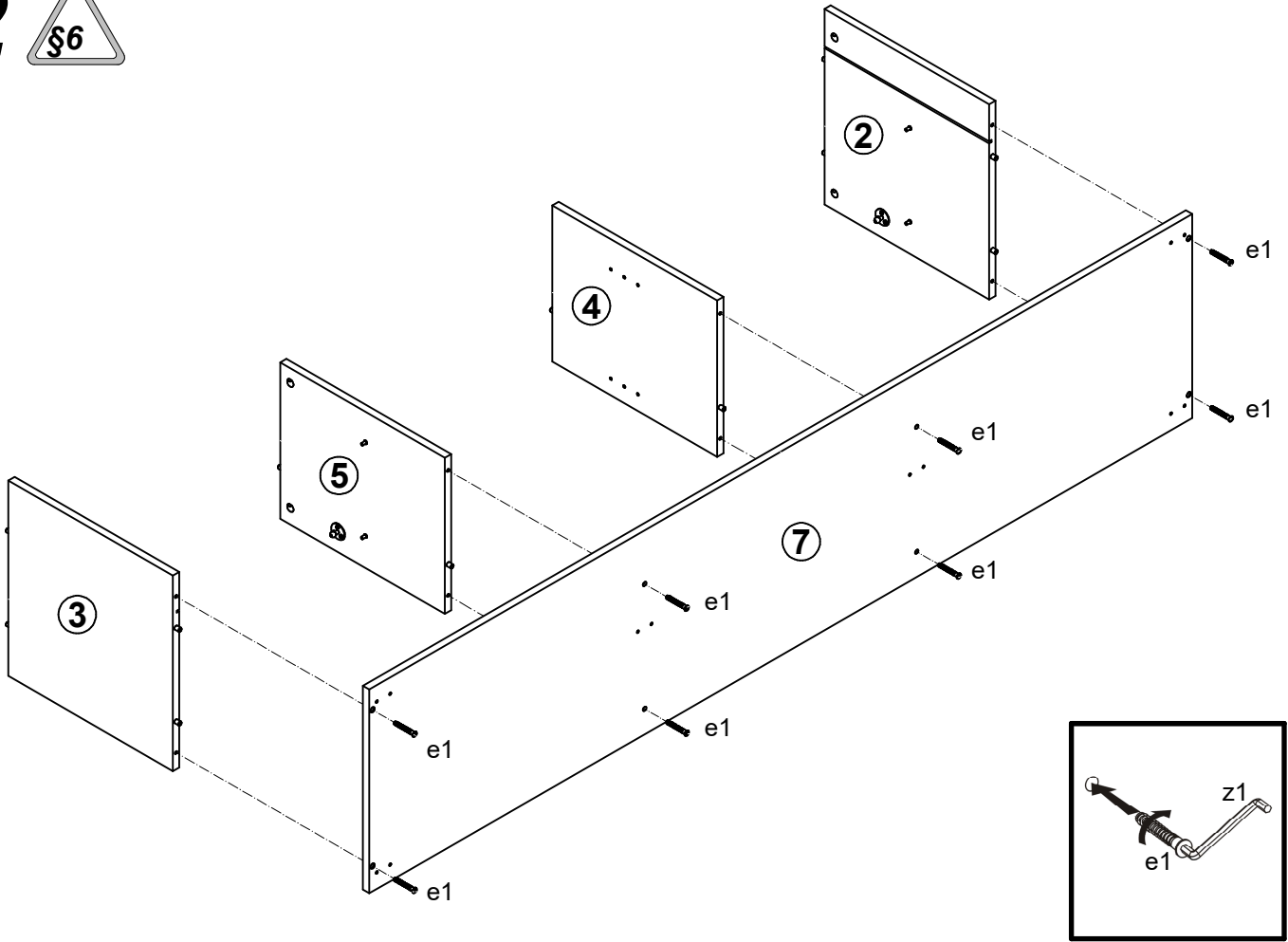

3

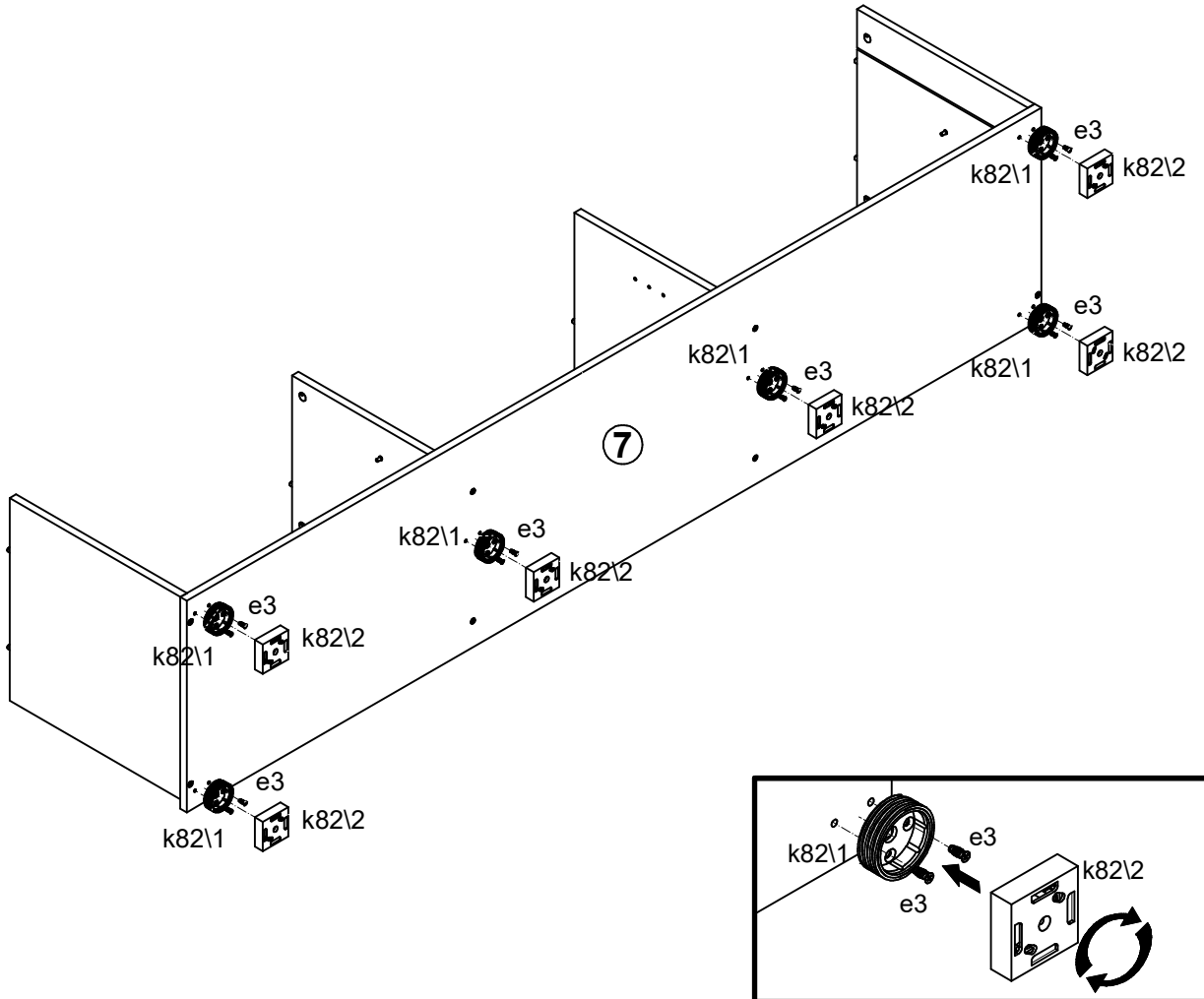

4

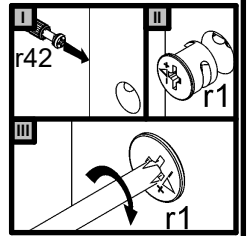
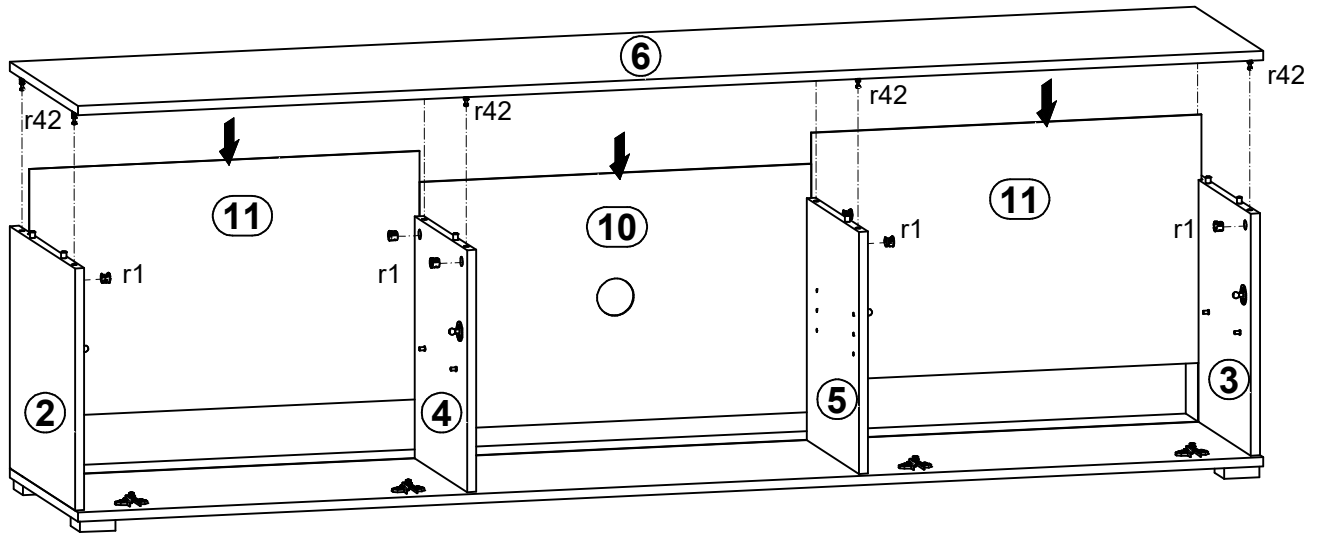

5

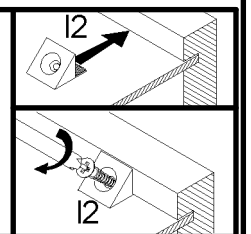
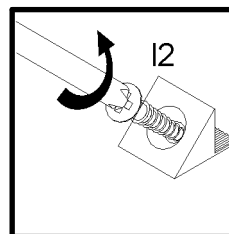
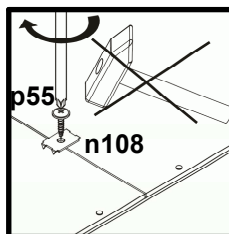
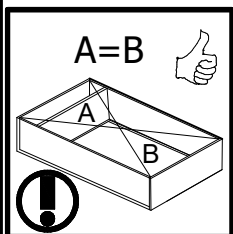
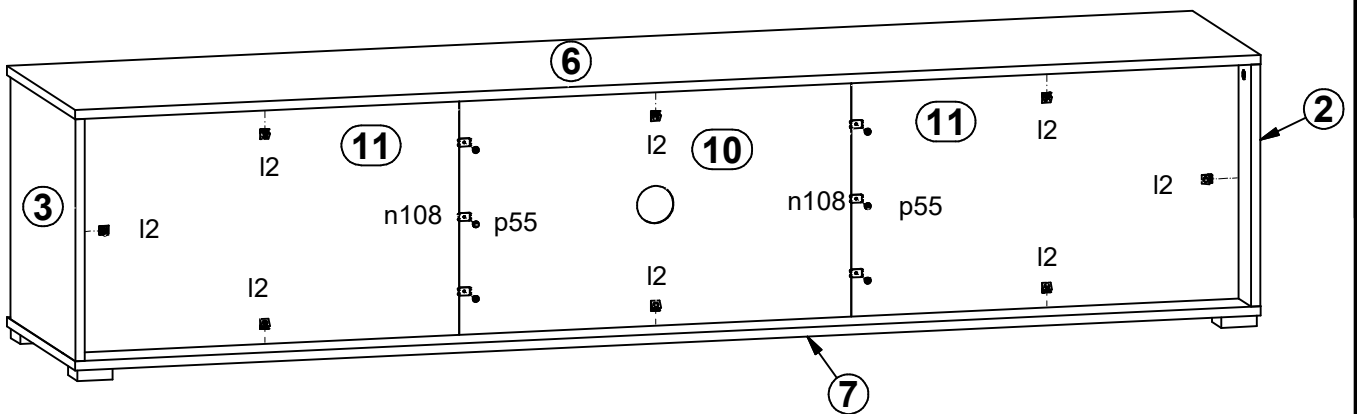

6

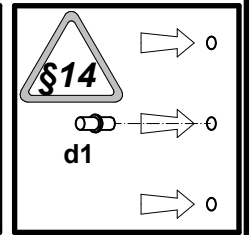
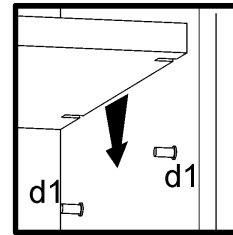
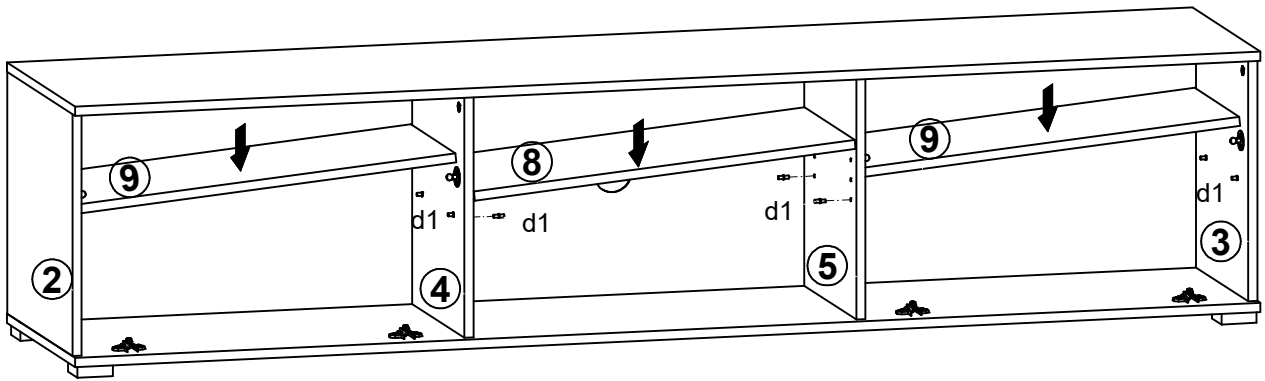

7

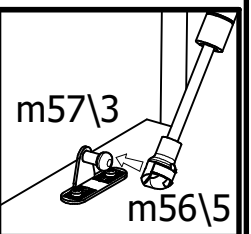
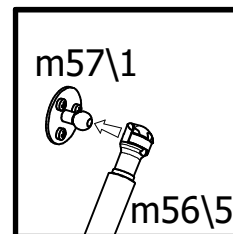
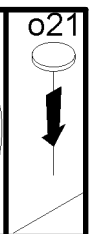
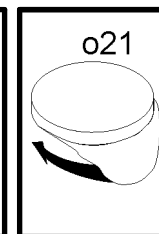
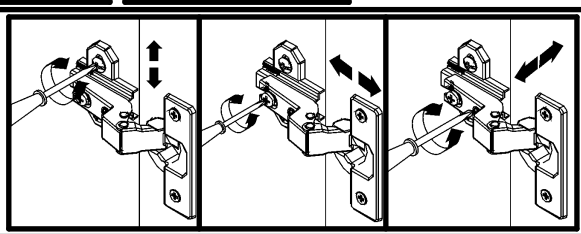
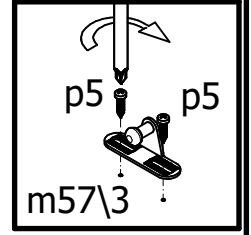
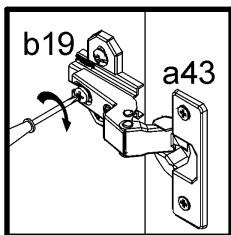
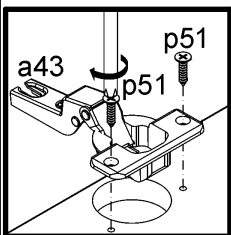
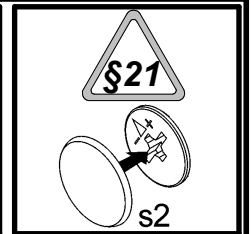
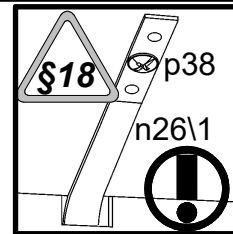
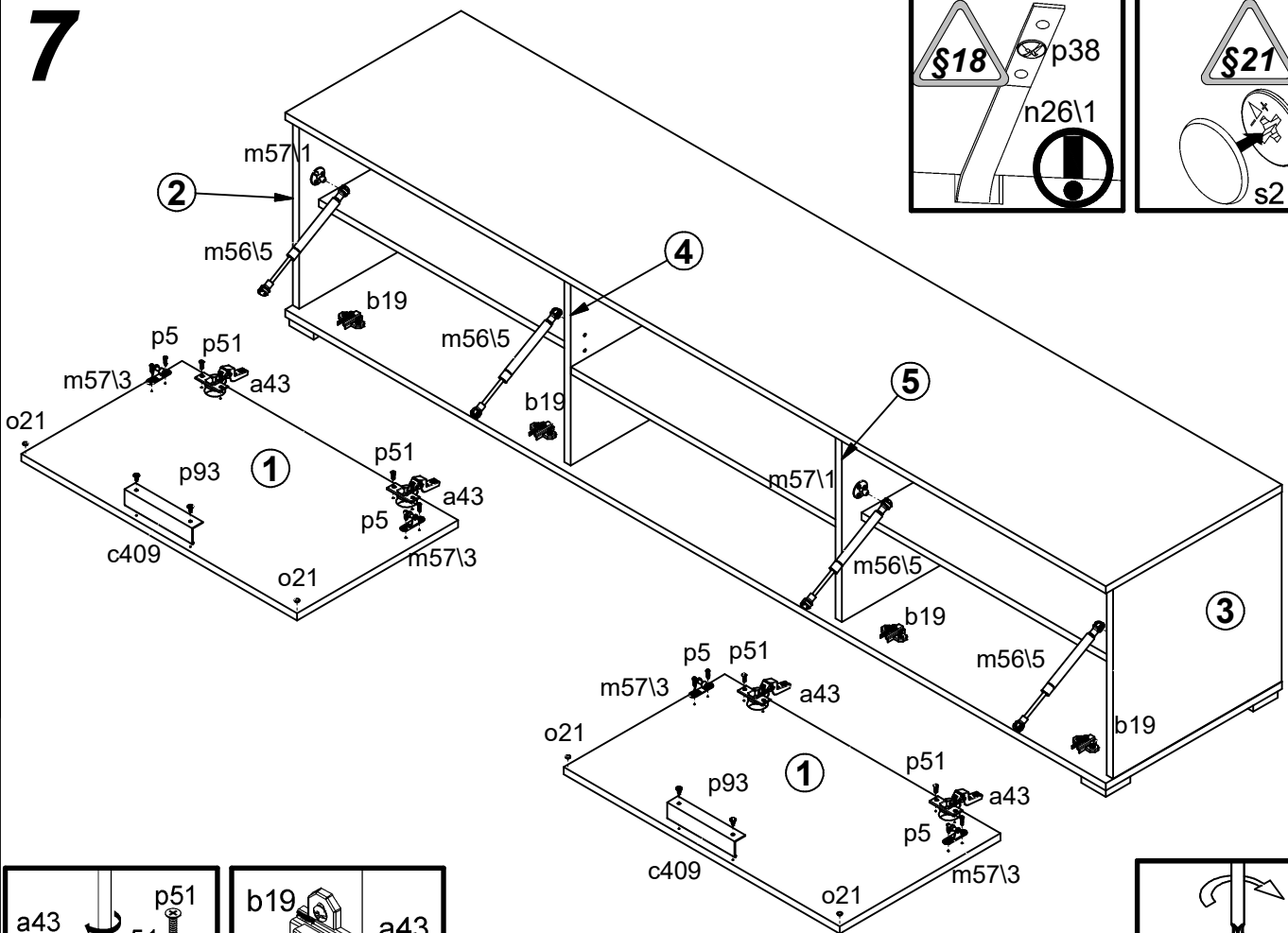

A**ZELE****M234-SZF2D**

A	B	C	D	
1	M234-0001	1896	305	2/4
2	M234-0002	1896	486	3/4
3	M234-1001	1904	540	3/4
4	M234-1002	1904	540	3/4
5	M234-2001	801	558	1/4
6	M234-2002	801	558	1/4
7	M234-3002	770	540	1/4
8	M234-9301	1929	795	2/4
9	dr-765	765	22	1/4

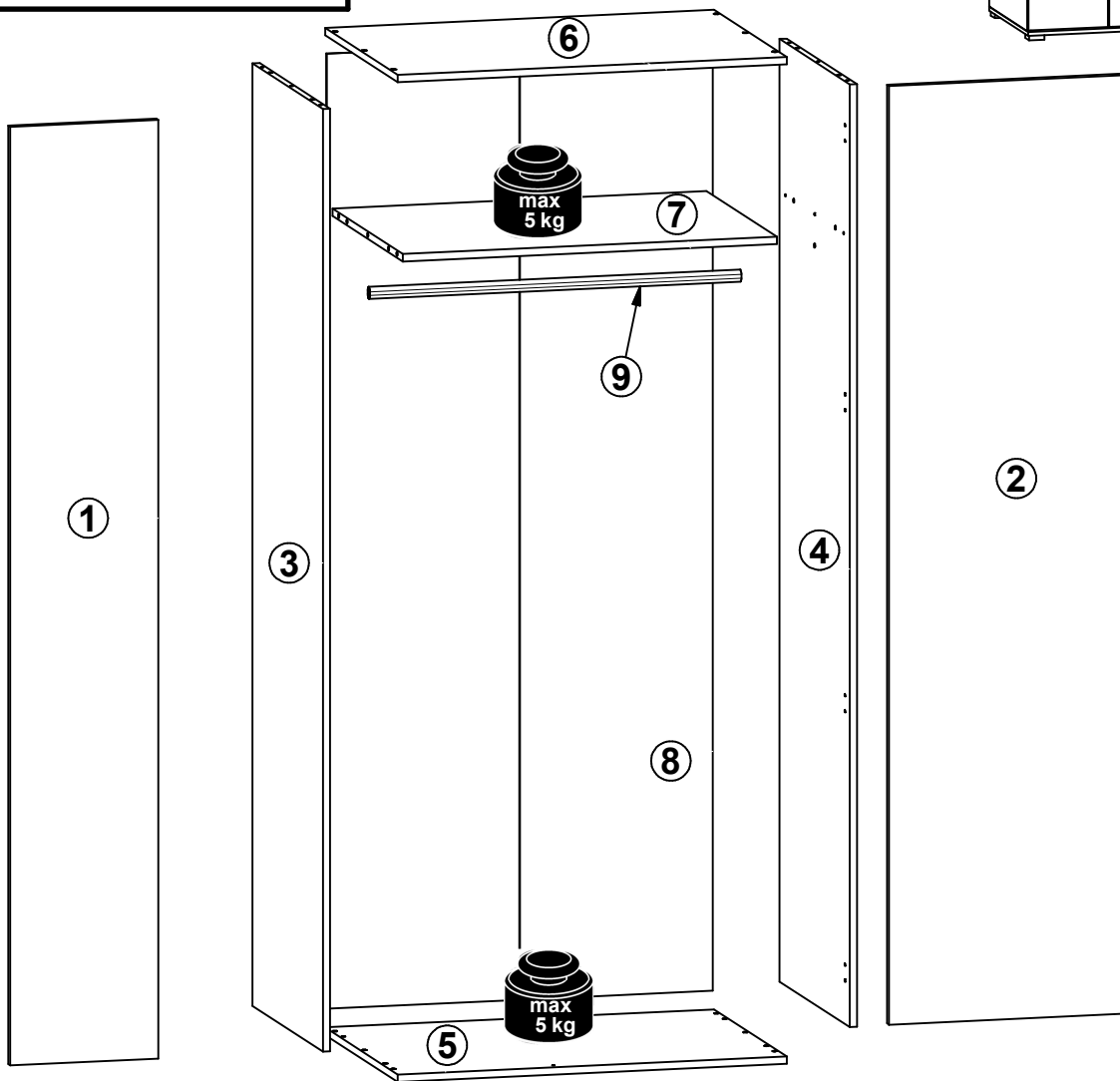
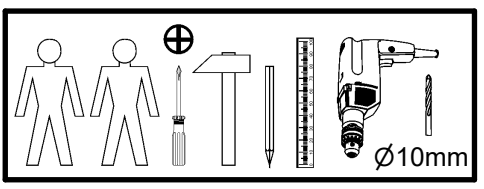
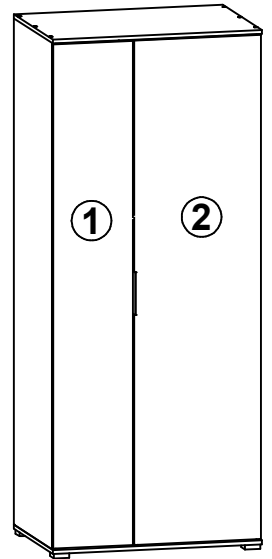
**B**

7x a44	7x b19	1x c409 128mm	1x d5 Ø6,3x15 mm	12x e1 Ø7x50 mm	8x e3 Ø6x13 mm	12x f1 Ø8x30 mm	1x f35 Ø10x50 mm	4x k8211 Ø51 mm
4x k8212 58x58x18 mm	60x l1 1,4x20 mm	2x n1 h=22mm	1x n1412 86x21x151,5	2x o21 silikon	2x p1 Ø3,5x13 mm	1x p17 Ø5x60 mm	2x p38 Ø3,5x16 mm	14x p51 Ø3,5x15 mm
2x p93 Ø4x13 mm	6x r1 Ø15x12 mm #16	6x r42 20/11	6x s2 Ø16	1x z1 4 mm				

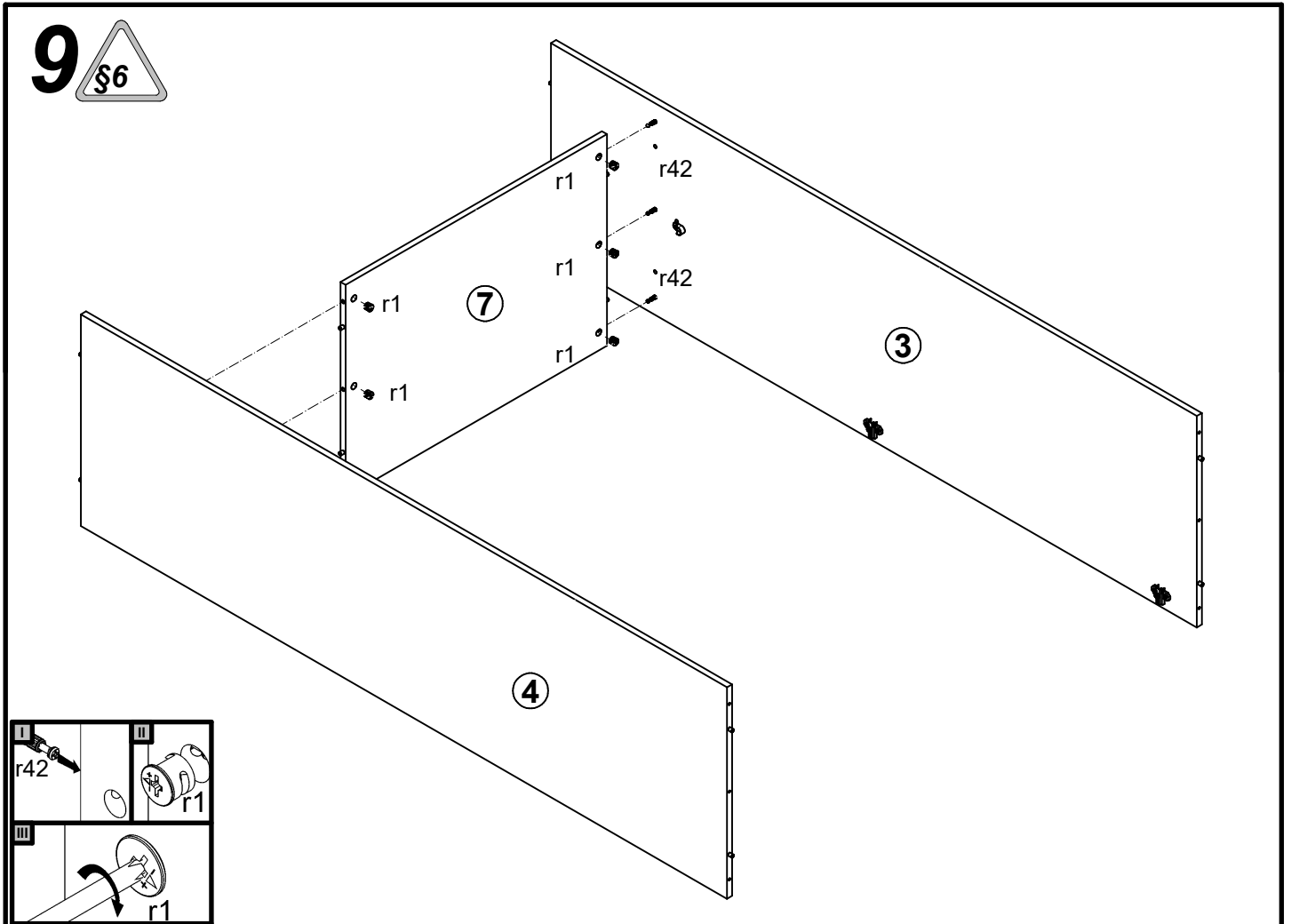
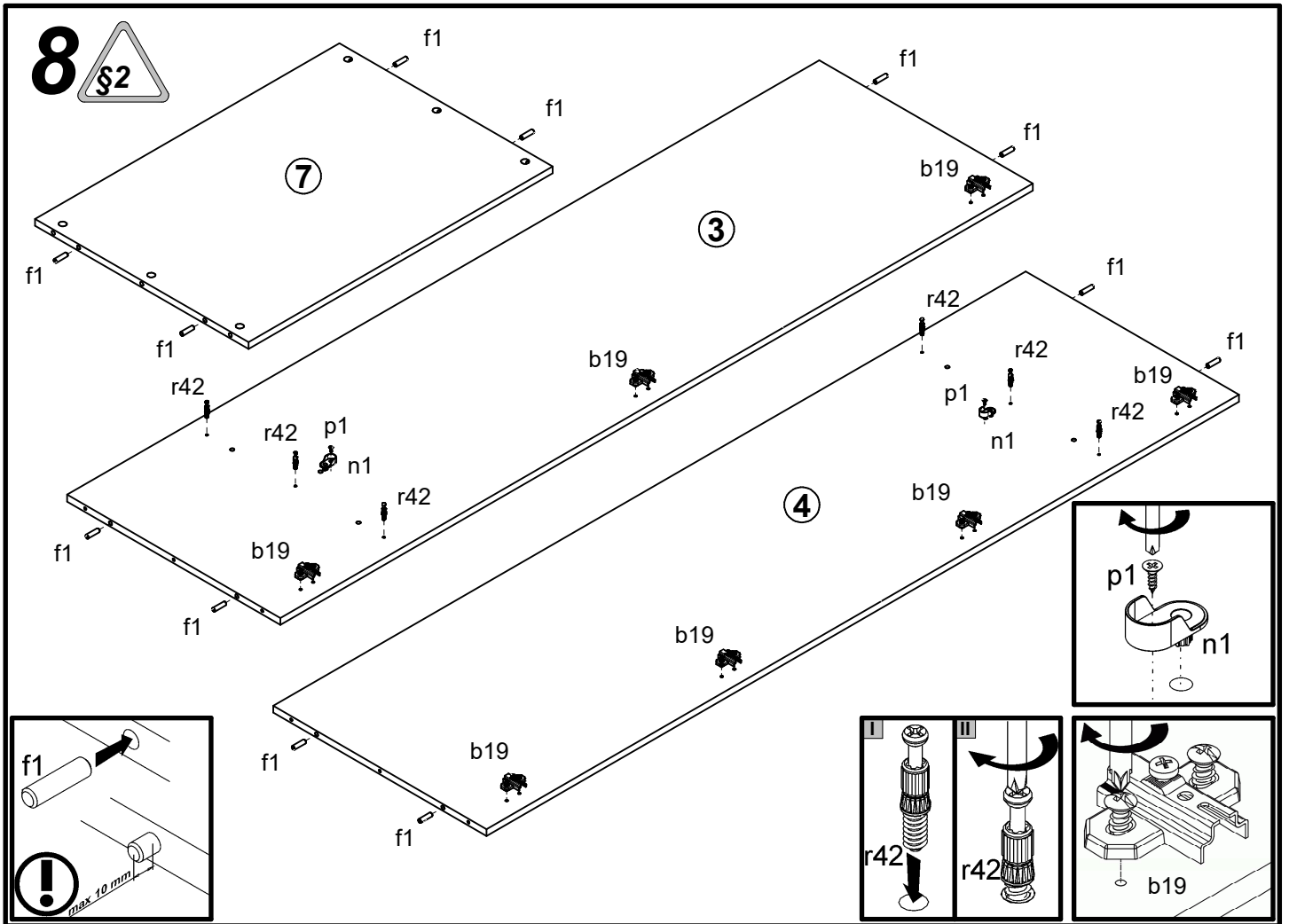

10

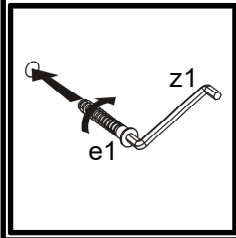
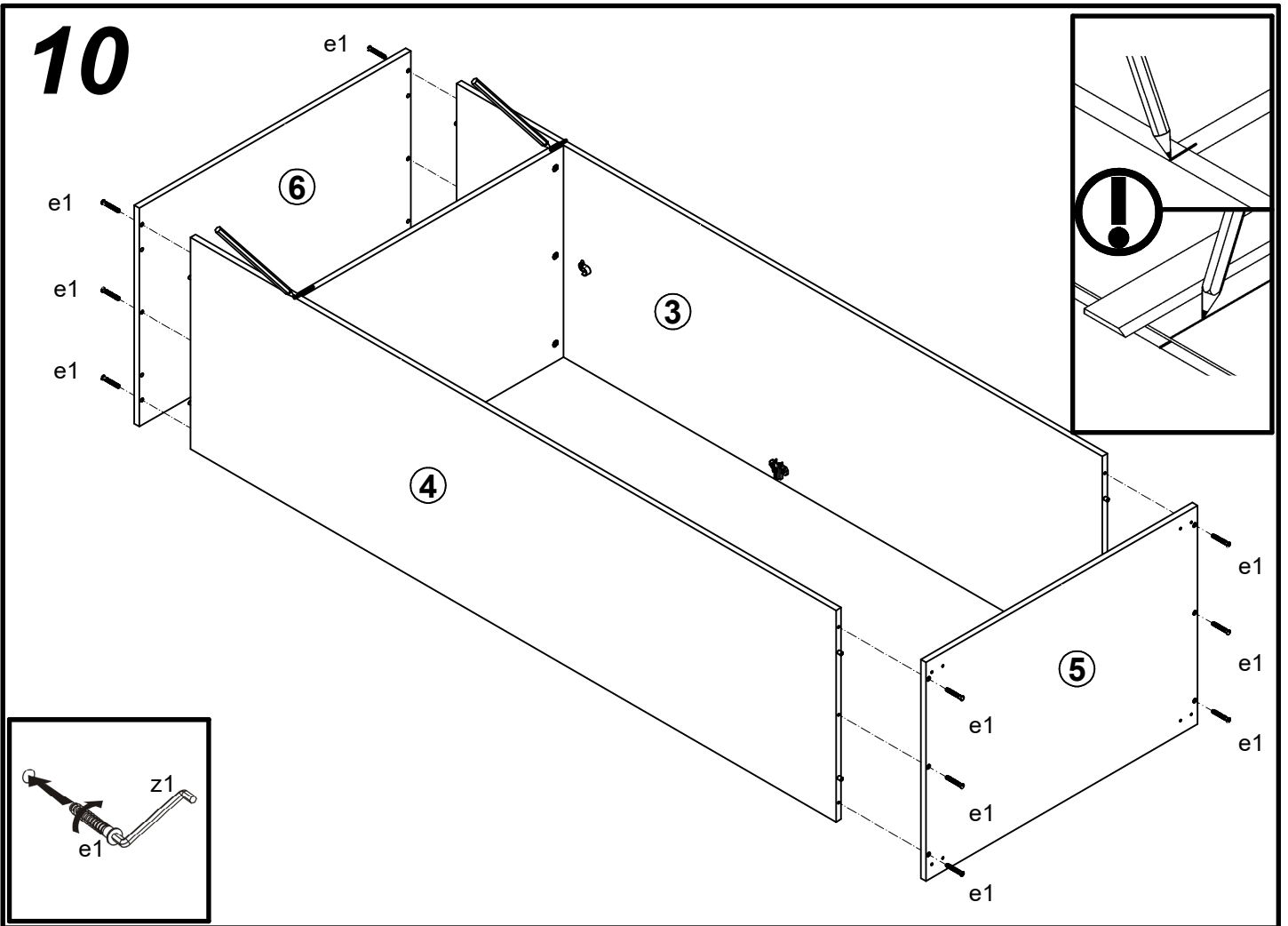

11

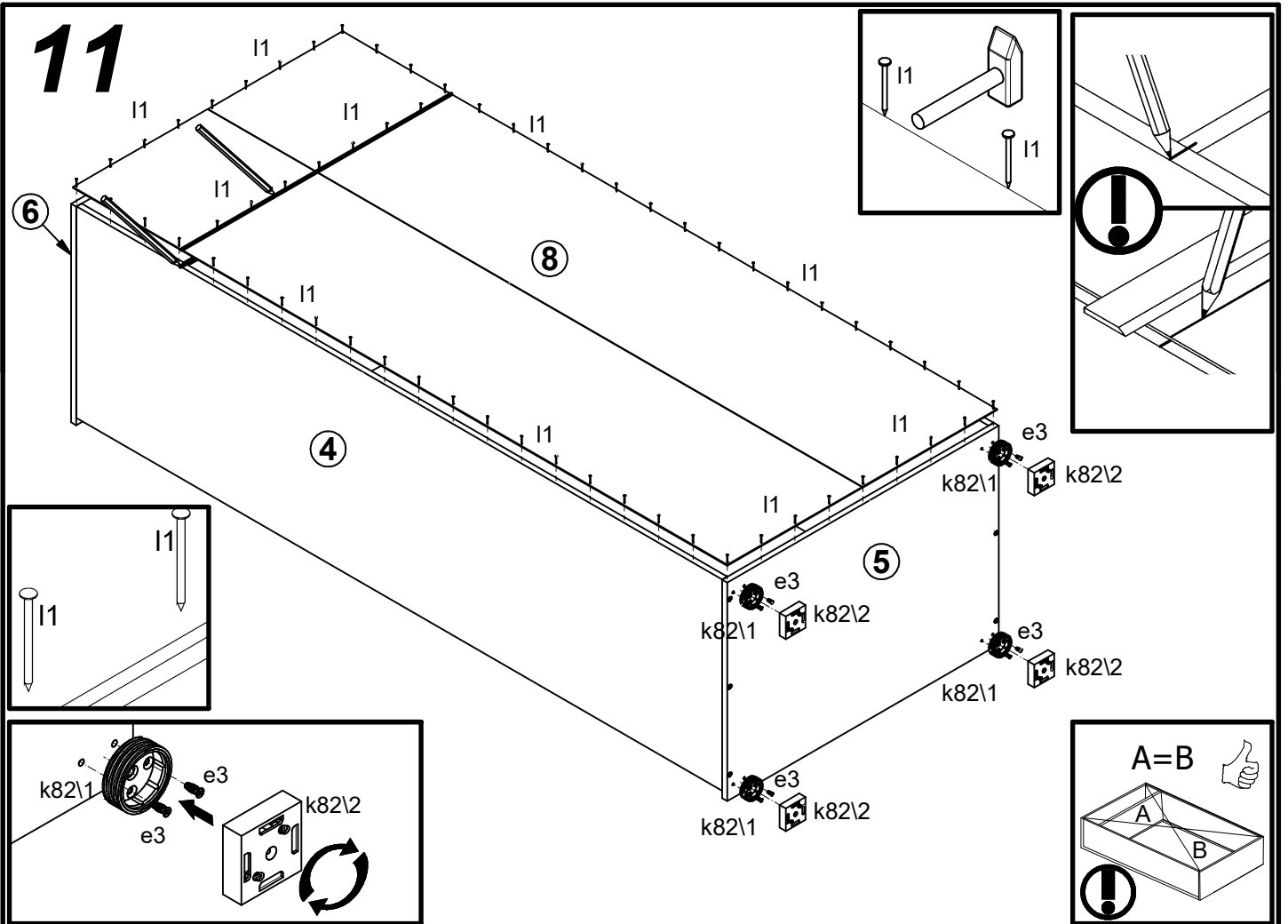

12

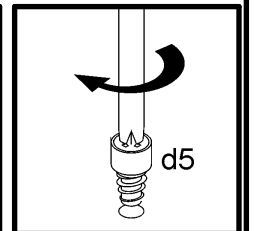
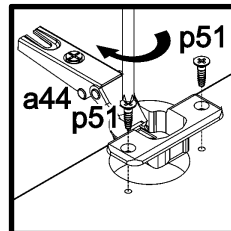
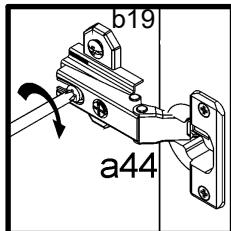
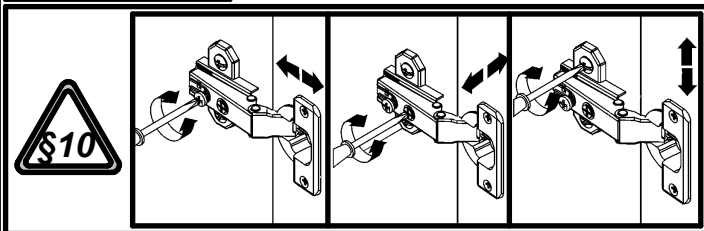
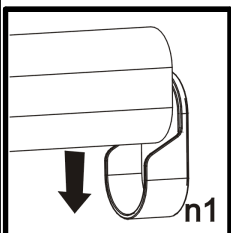
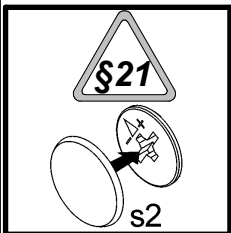
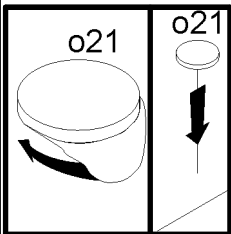
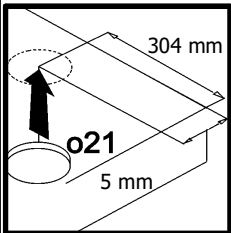
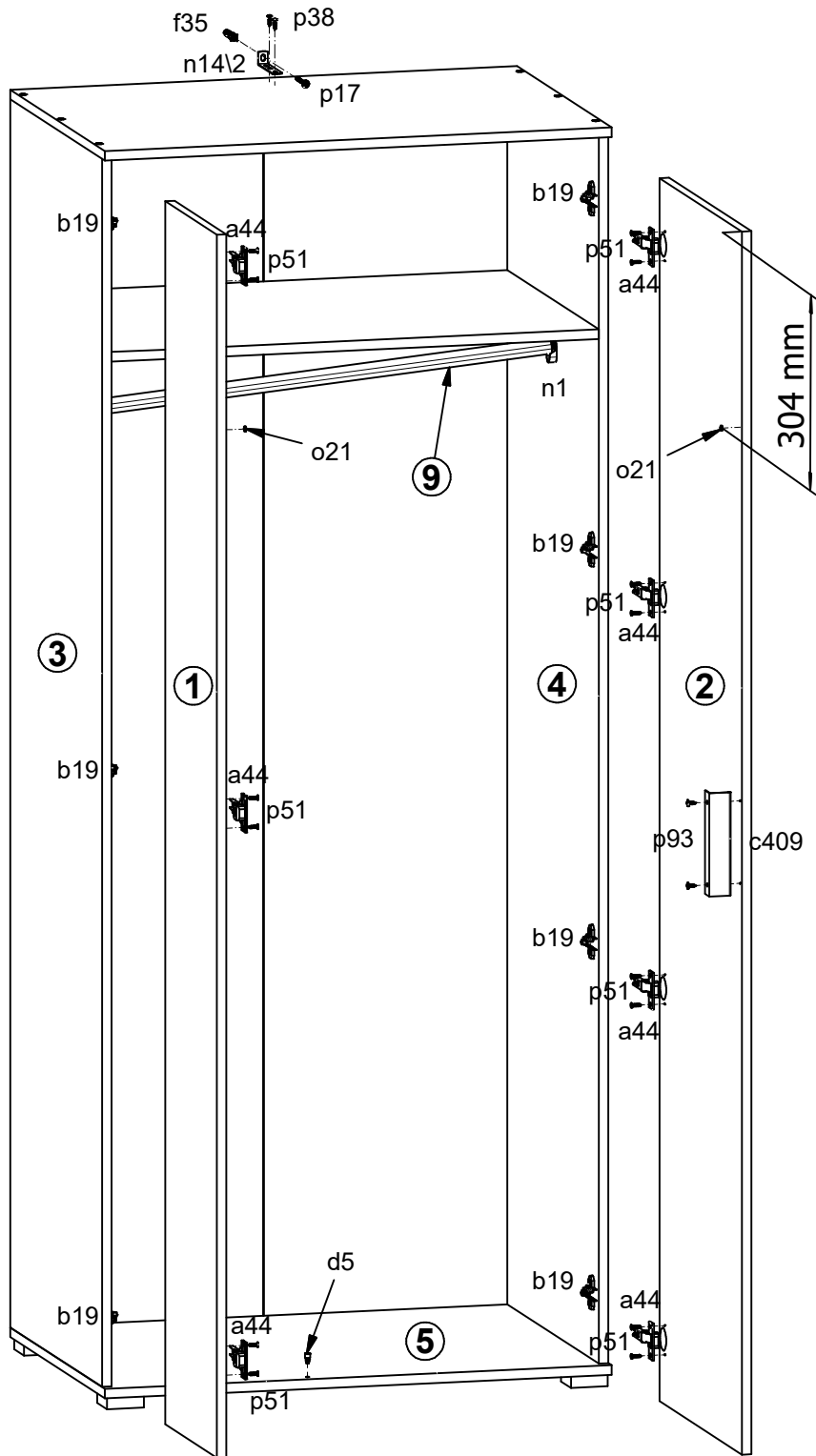
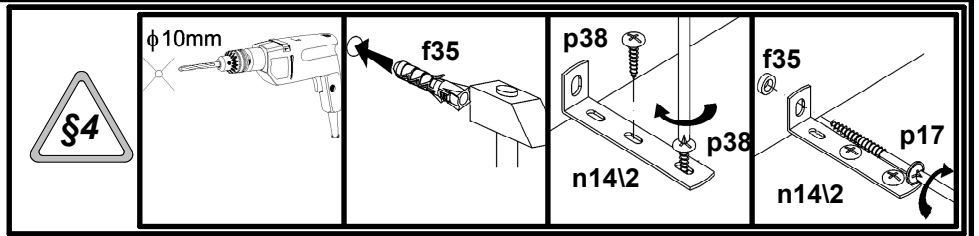

A

ZELE

M234-SFW1W1D

A	B	C	D
1	M234-0004	955	340
2	M234-0005	955	300
3	M234-1007	963	300
4	M234-1008	963	300
5	M234-1009	963	280
6	M234-2006	650	318
7	M234-3005	301	279
8	M234-5001	301	270
9	M234-9002	973	314
10	M234-9003	973	314



C

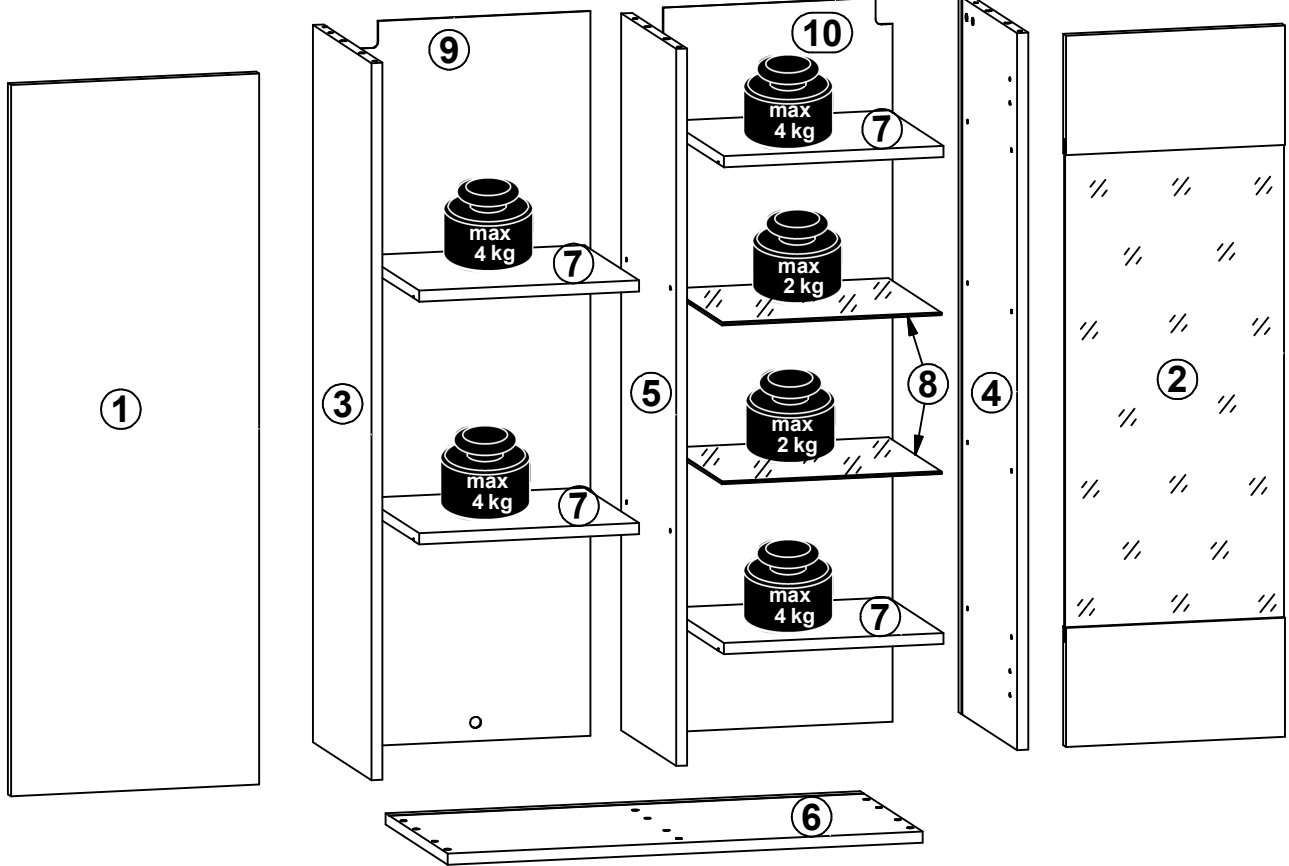
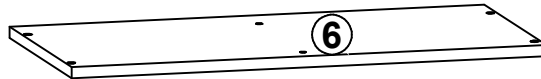
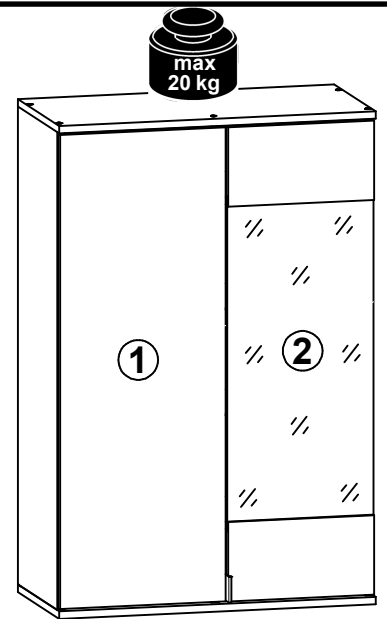
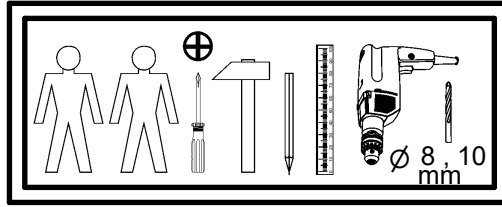

4x a44	4x b19	1x c332	16x d1	8x d3	12x e1	12x f1	1x f28	2x f35
10x i2	5x n108	1x n165L	1x n165P	1x n211	4x o21	4x p21	8x p51	5x p55
1x p74	3x p93	2x p127	12x s1	1x s68	1x z1	1x n26\1	1x p38	

13

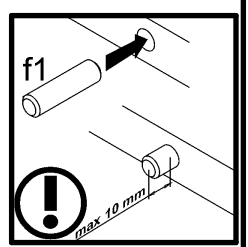
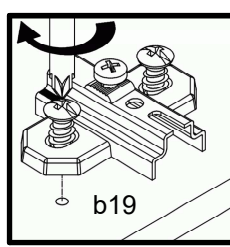
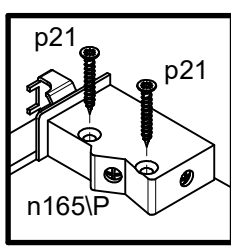
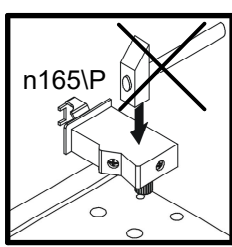
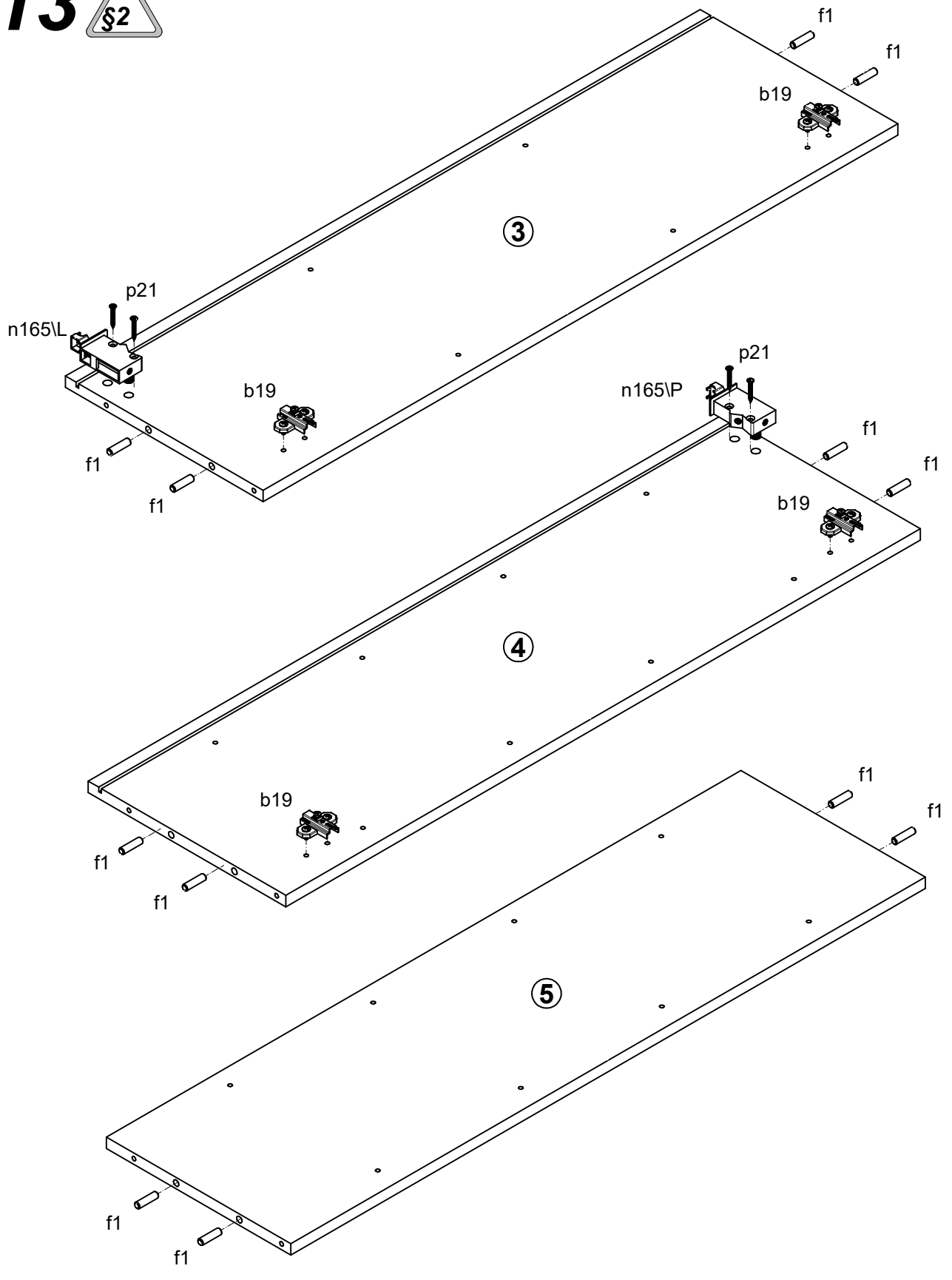

14

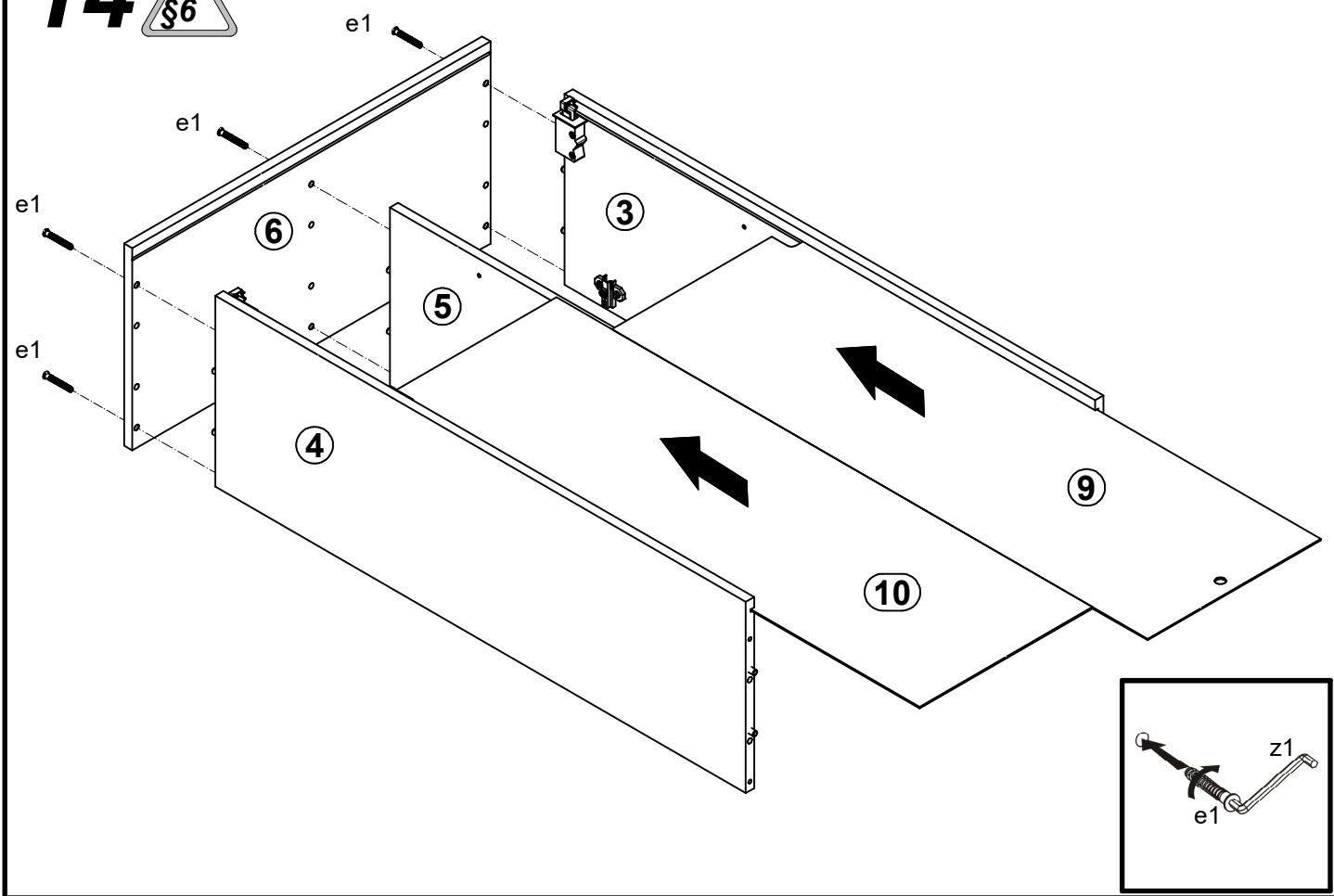

15

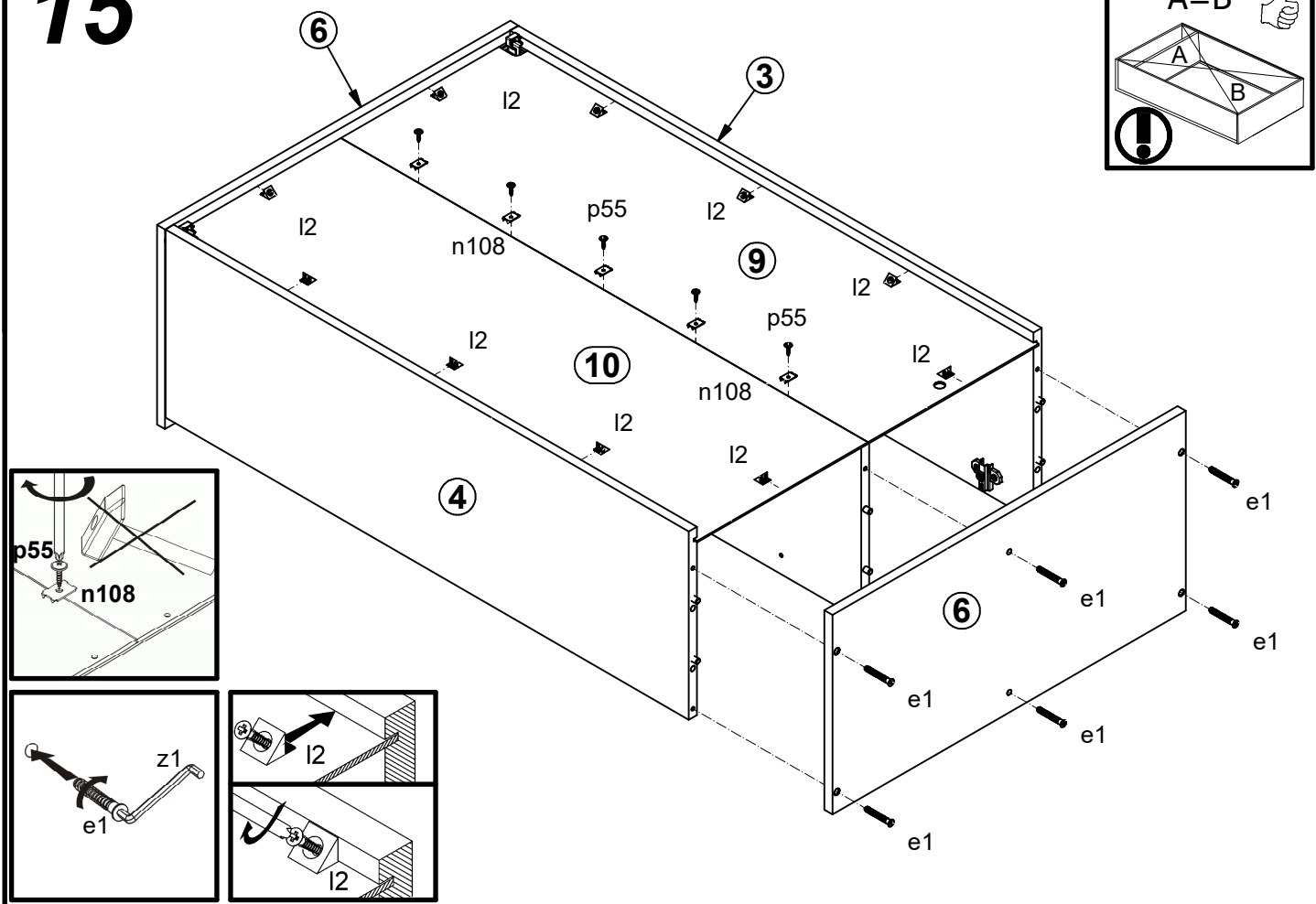
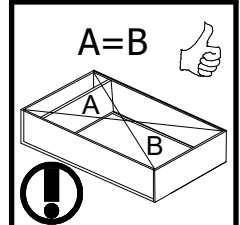

16

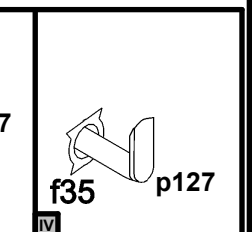
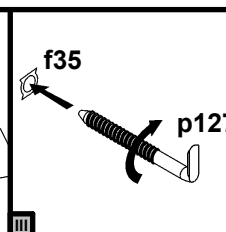
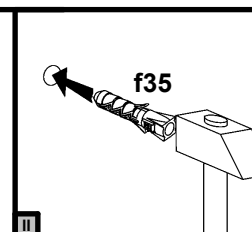
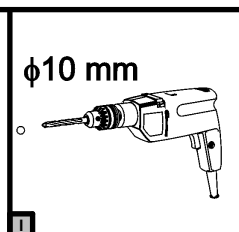
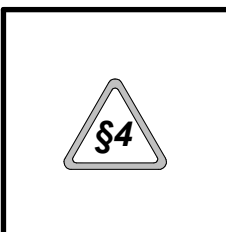
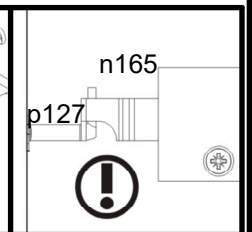
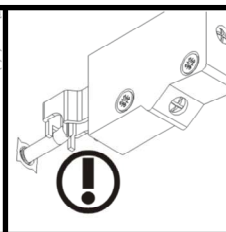
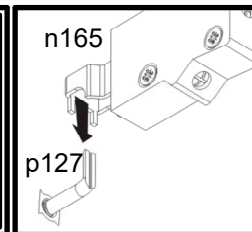
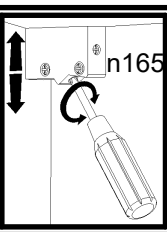
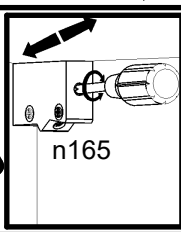
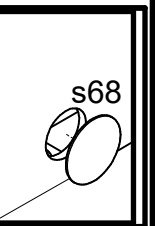
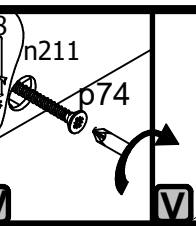
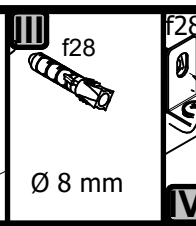
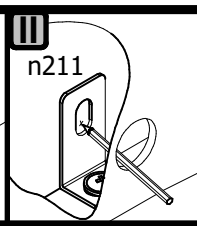
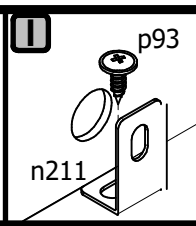
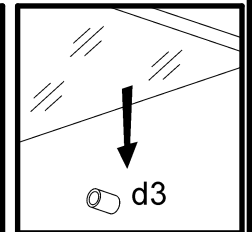
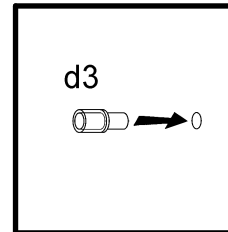
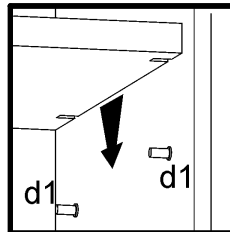
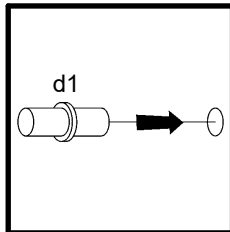
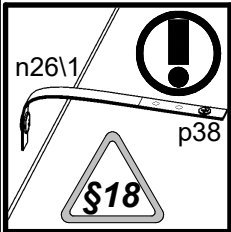
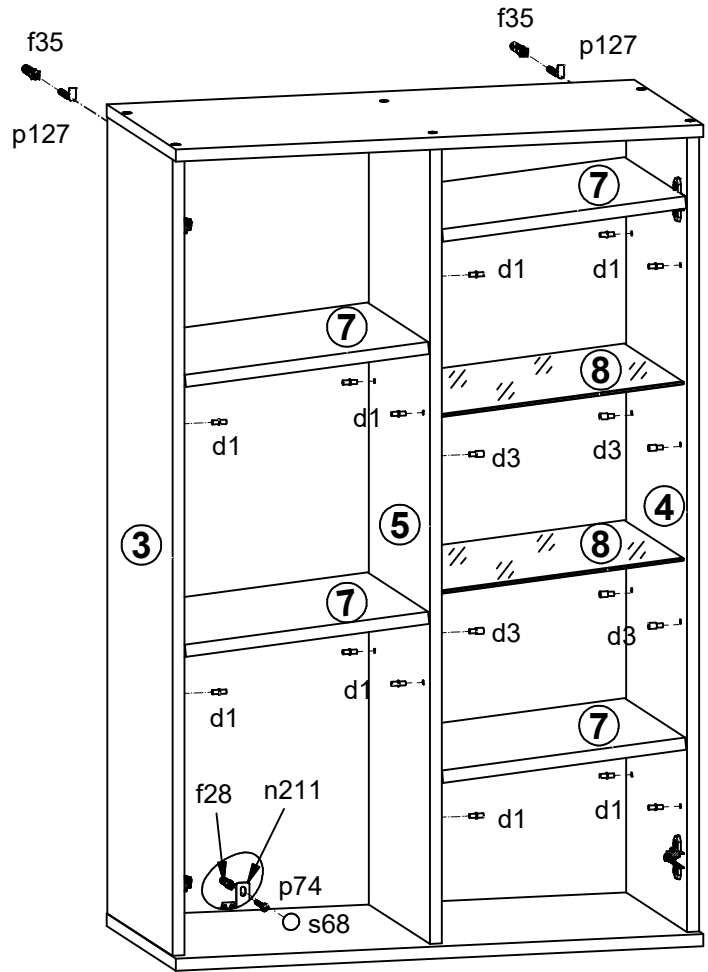
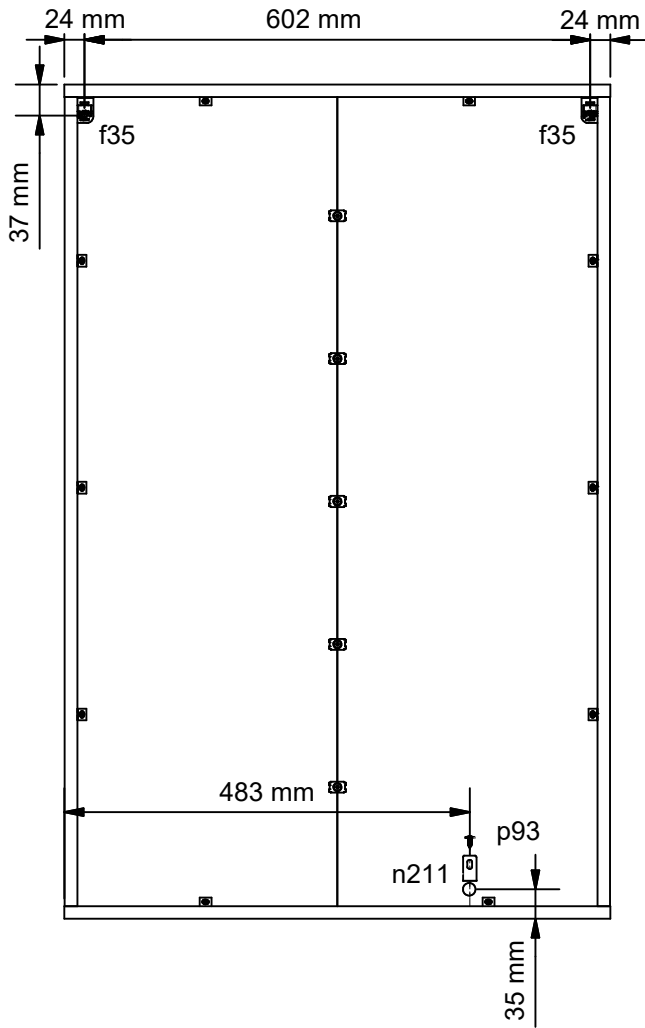

17

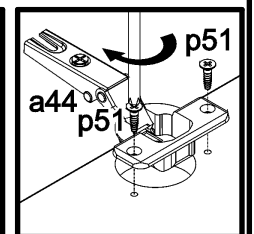
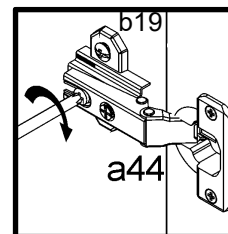
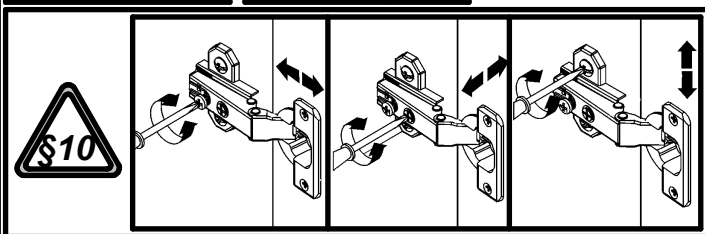
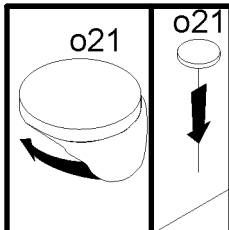
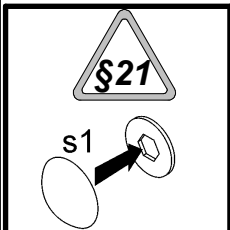
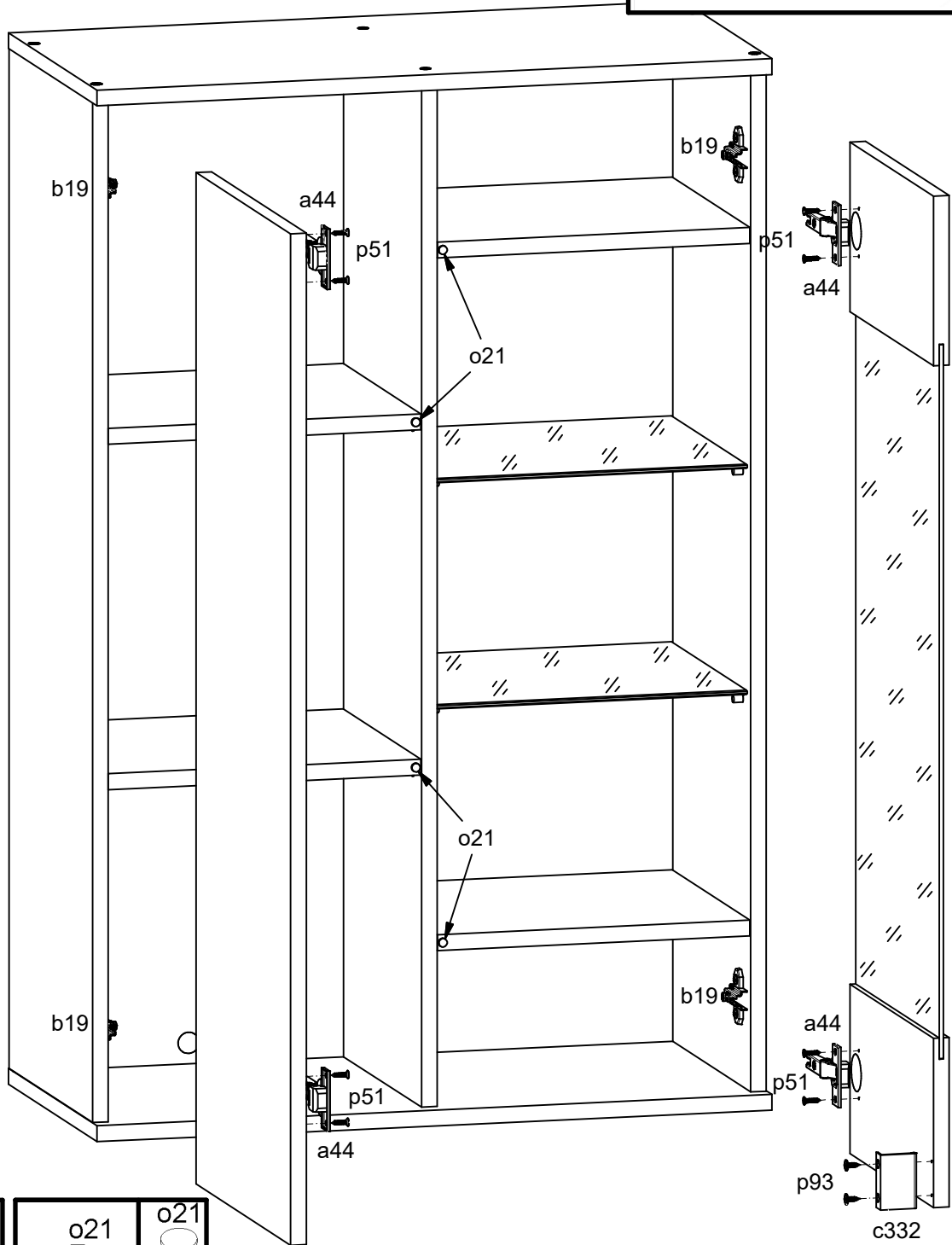
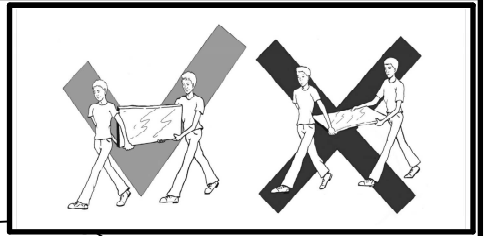

A**ZELE****M234-POL/90**

A	B	C	D
1	M234-3001	899	170
2	M234-4001	900	200

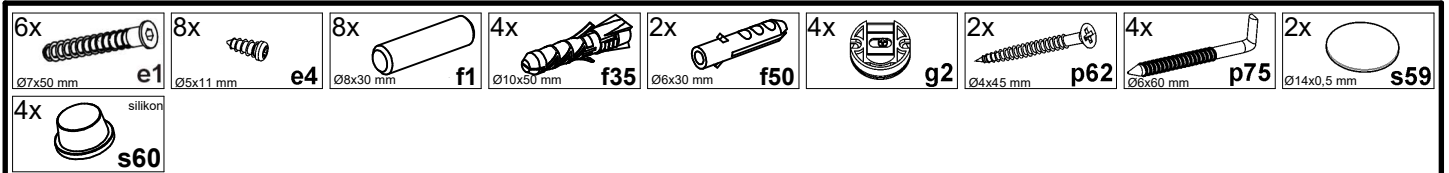
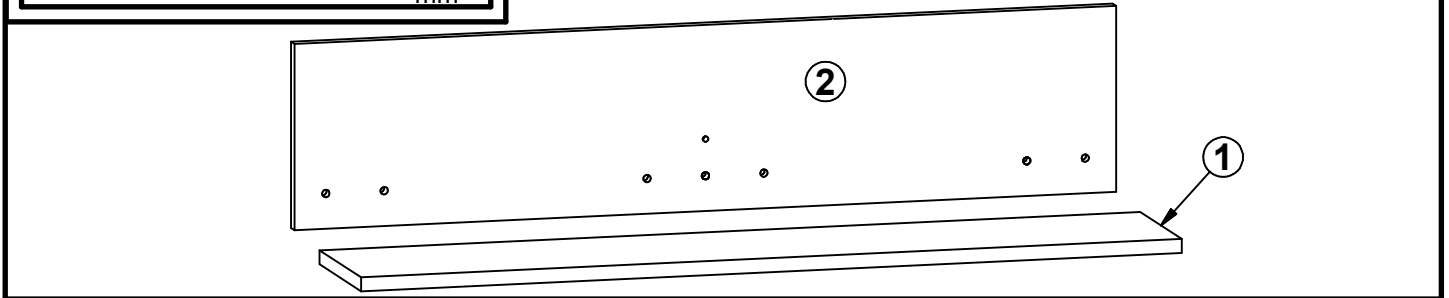
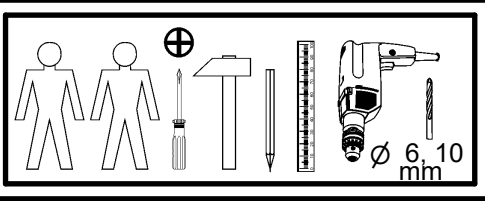
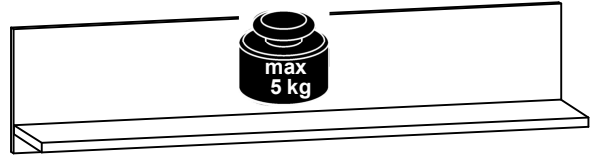
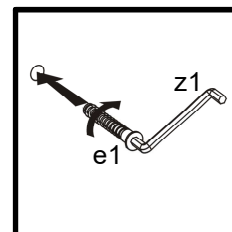
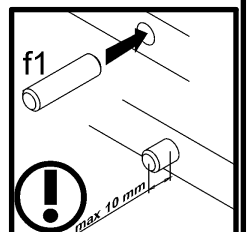
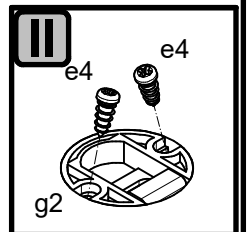
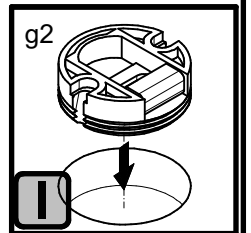
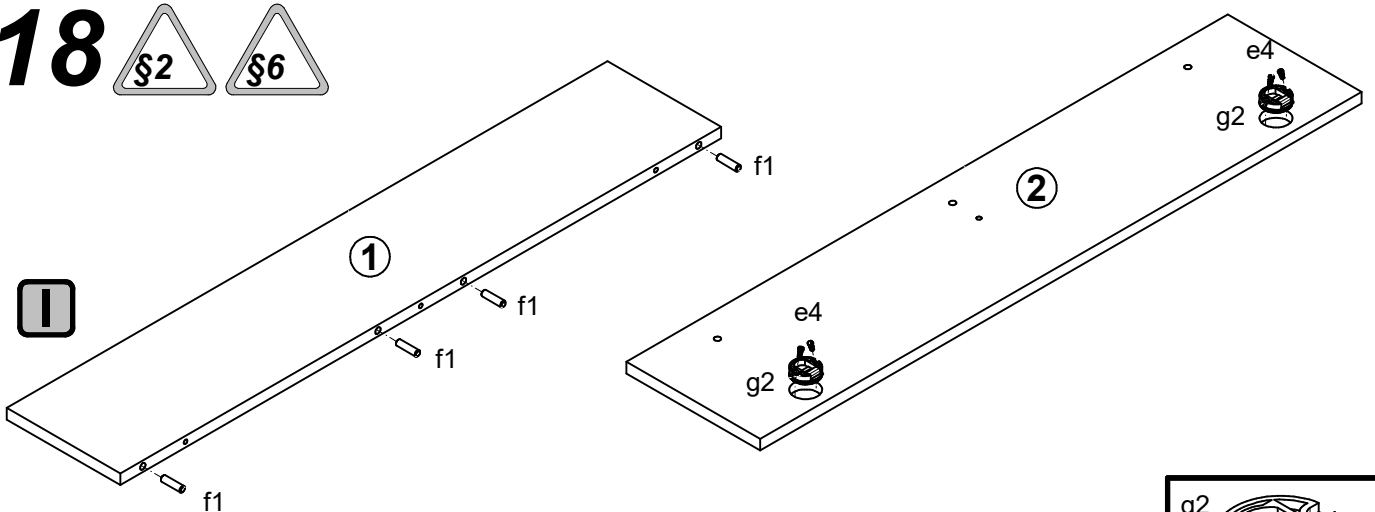
**D**
x2**18**

19

