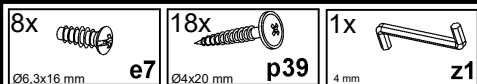
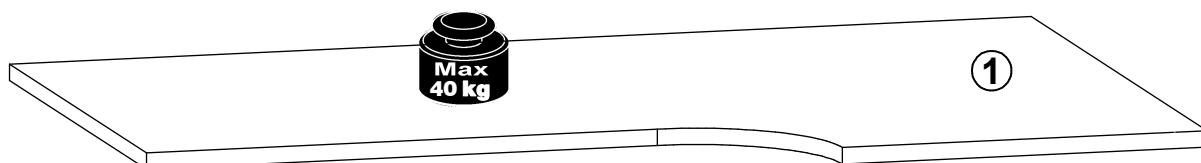
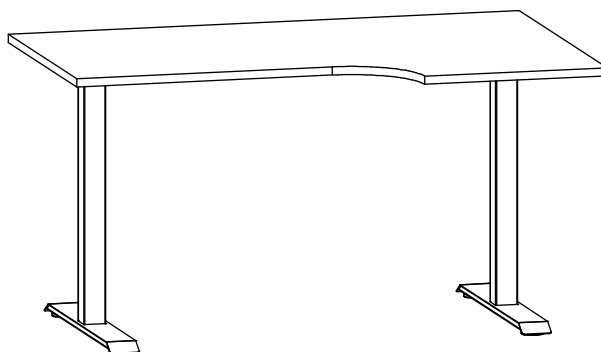
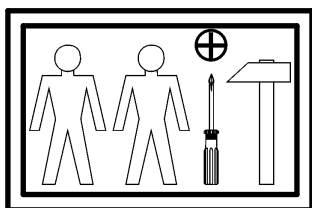
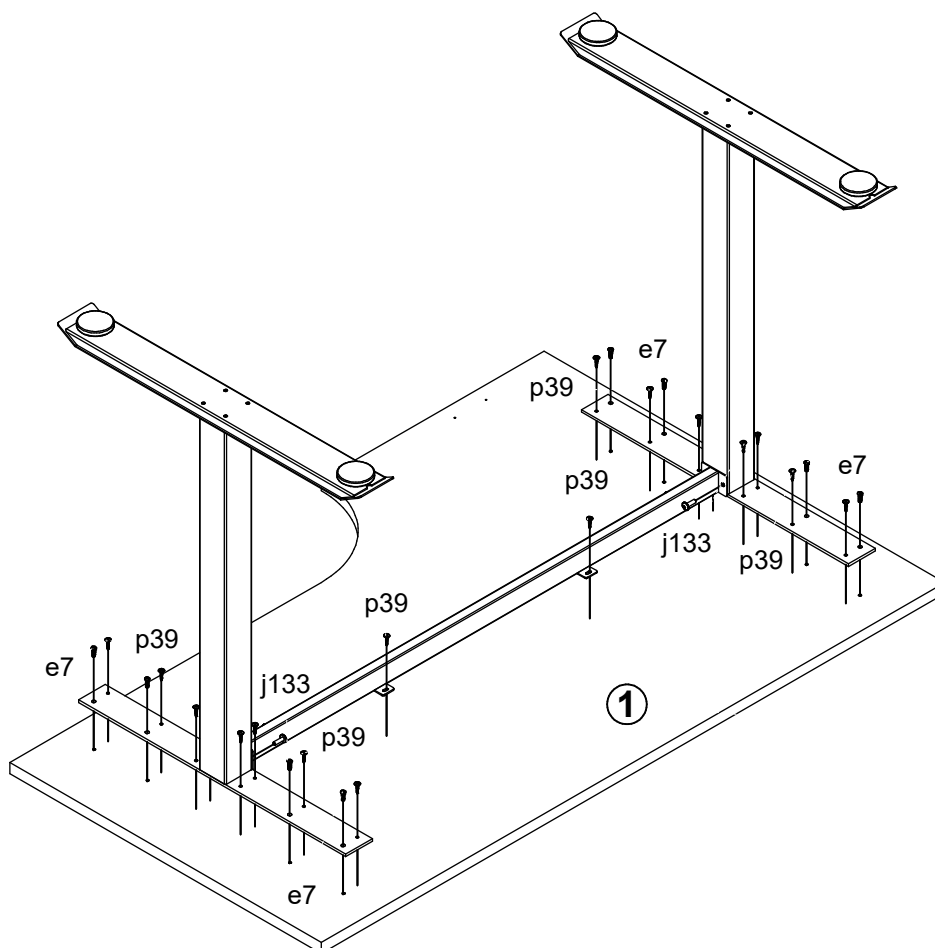

**A****OFFICE SPACE****S479-BIU/140/90/A/P**

A	B	C	D
1	S479-2012	1400	900 1/3

**1**

**A****OFFICE SPACE****S479-BIU/140/90/B/P**

A	B	C	D
1	S479-2012	1400	900 1/2

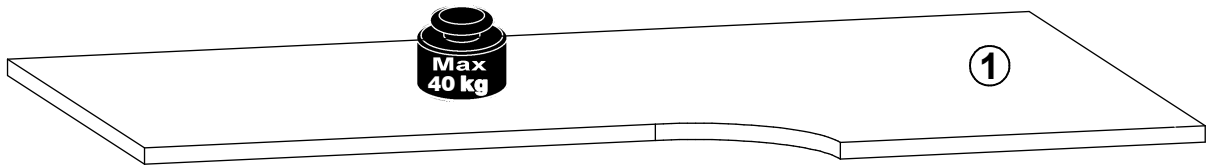
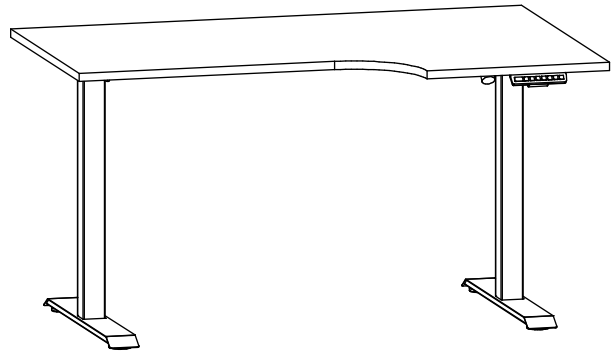
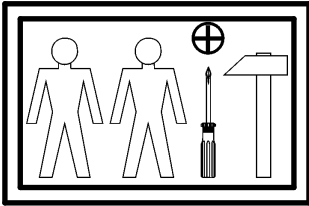

8x Ø6.3x16 mm e7	4x Ø4x20 mm p39	2x Ø4x16 mm p131
------------------------	-----------------------	------------------------

**1**