

A	B	C	D	
1	S488-0003	758	509	3/3
2	S488-0004	758	509	3/3
3	S488-1001	864	399	2/3
4	S488-1002	864	399	2/3
5	S488-1003	848	379	2/3
6	S488-1004	848	379	2/3
7	S488-2002	1698	399	1/3
8	S488-3003	1667	379	1/3
9	S488-3004	569	373	1/3
10	S488-3005	496	373	1/3
11	S488-5502	800	80	1/3
12	S488-5503	800	80	1/3
13	S488-5505	1667	75	1/3
14	S488-5506	1700	80	1/3
15	S488-9303	866	583	2/3
16	S488-9304	866	583	2/3
17	S488-9305	866	511	2/3

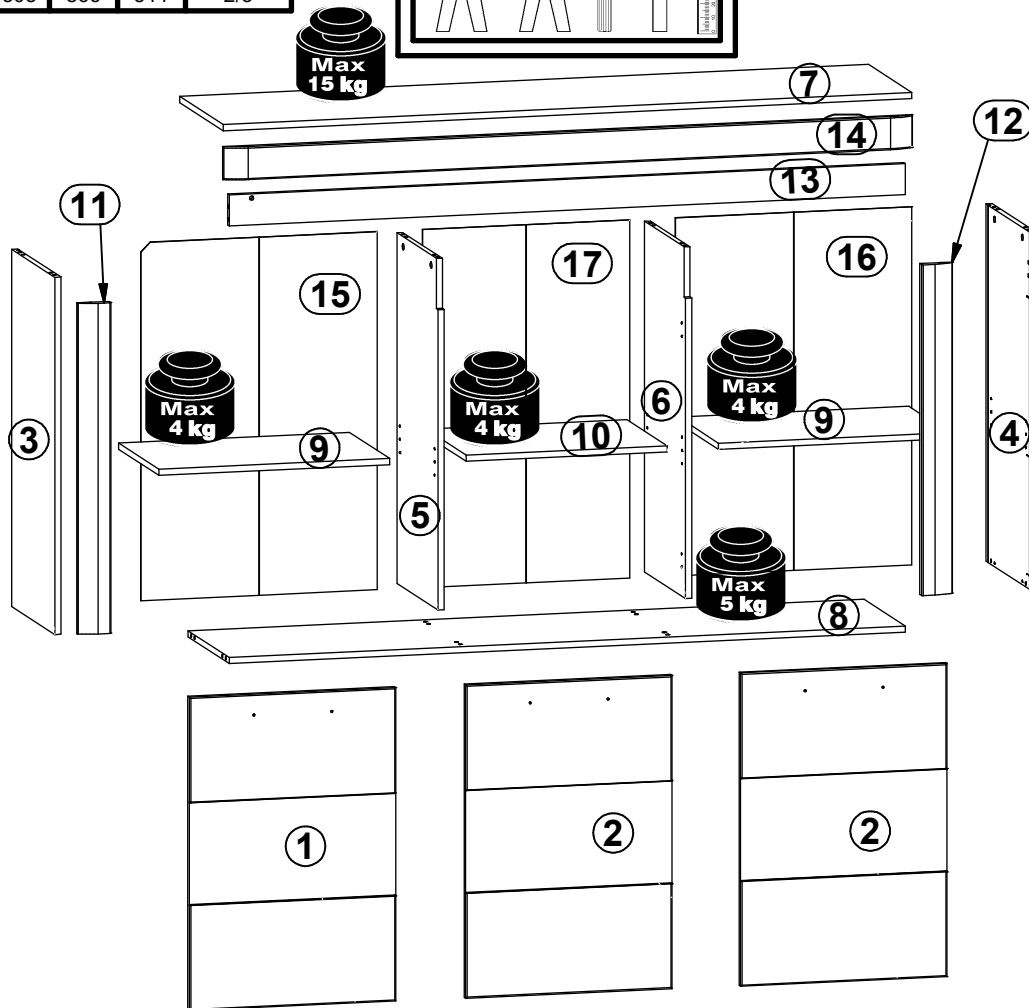

4x a132	3x a133	2x a159	4x b43	2x b78	3x c342/3	12x d1	5x d36	6x d37	
4x e1	12x e2	20x f1	6x j30	6x k27	10x l2	8x n108	1x o70/10	5x o77/16	
1x o77/63	2x o83/9	5x p15	34x p38	12x p51	20x p55	12x r1	12x r42	8x s68	
1x z1	1x n26/1	1x p38							

1 

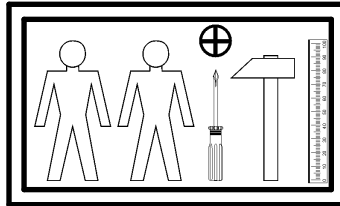
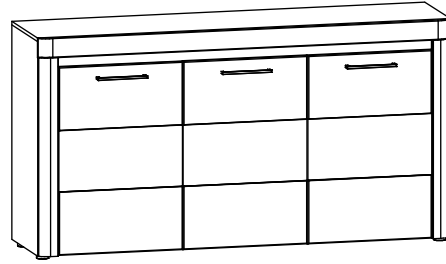
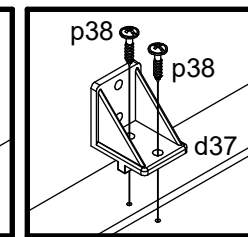
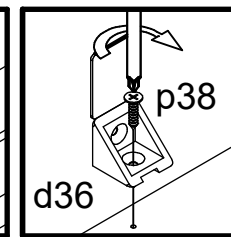
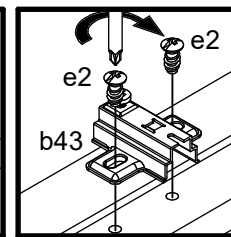
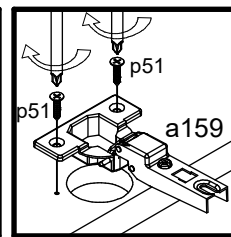
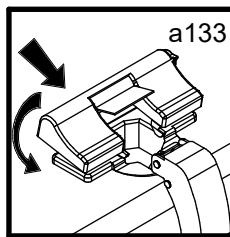
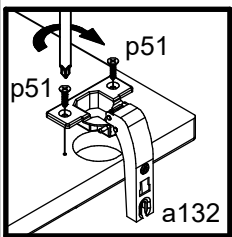
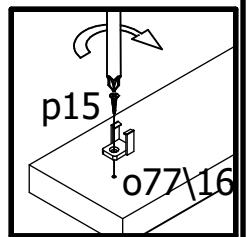
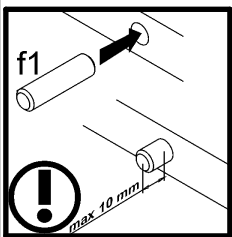
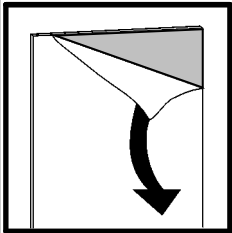
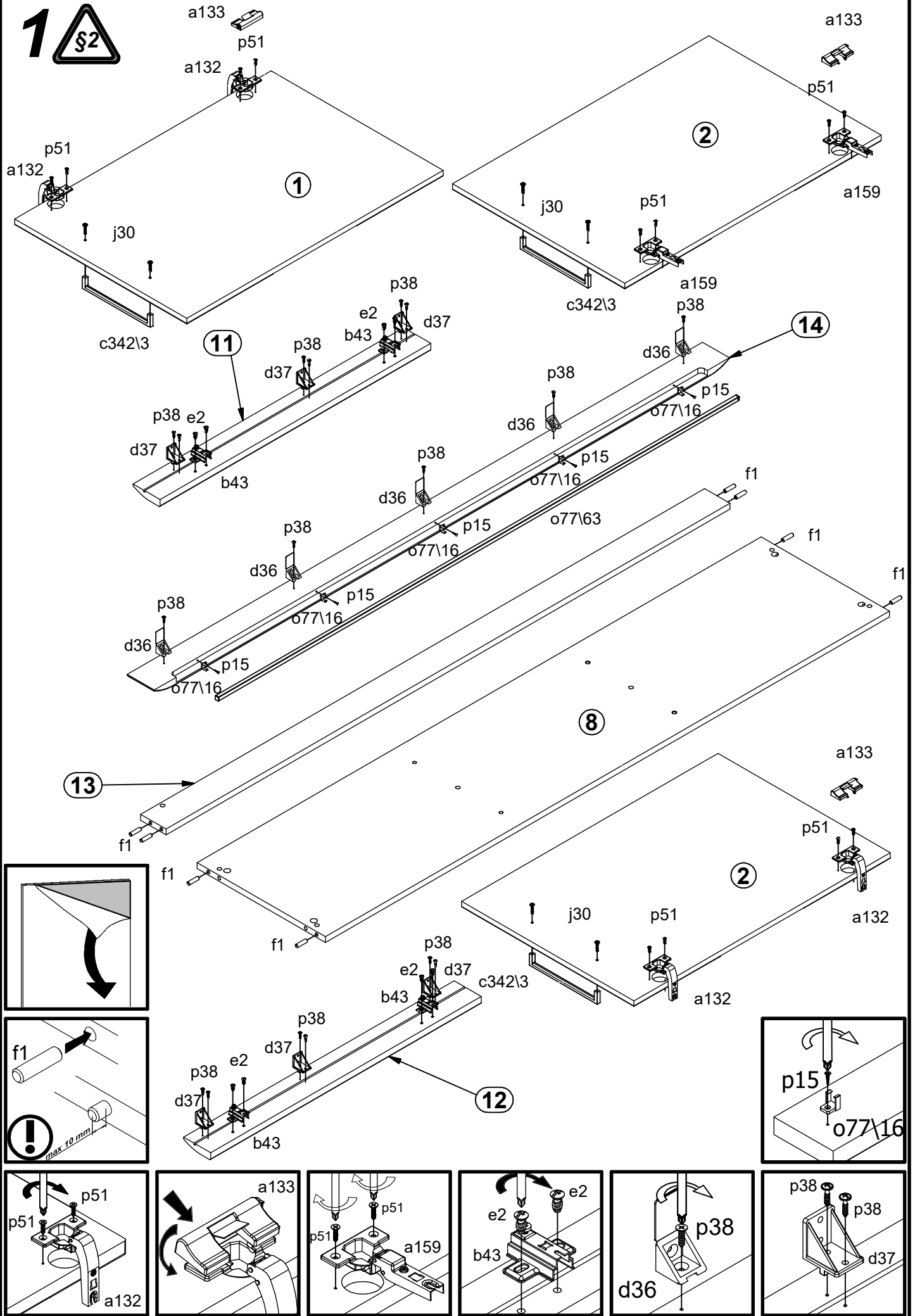

2

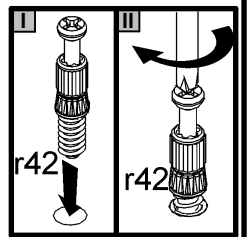
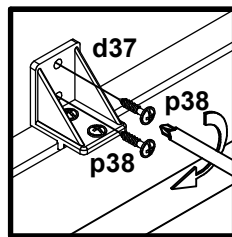
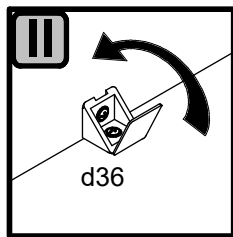
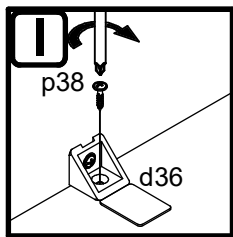
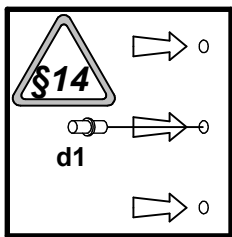
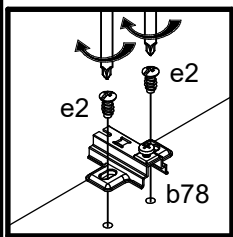
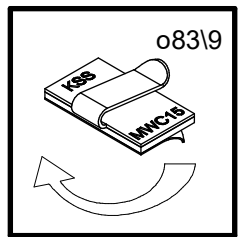
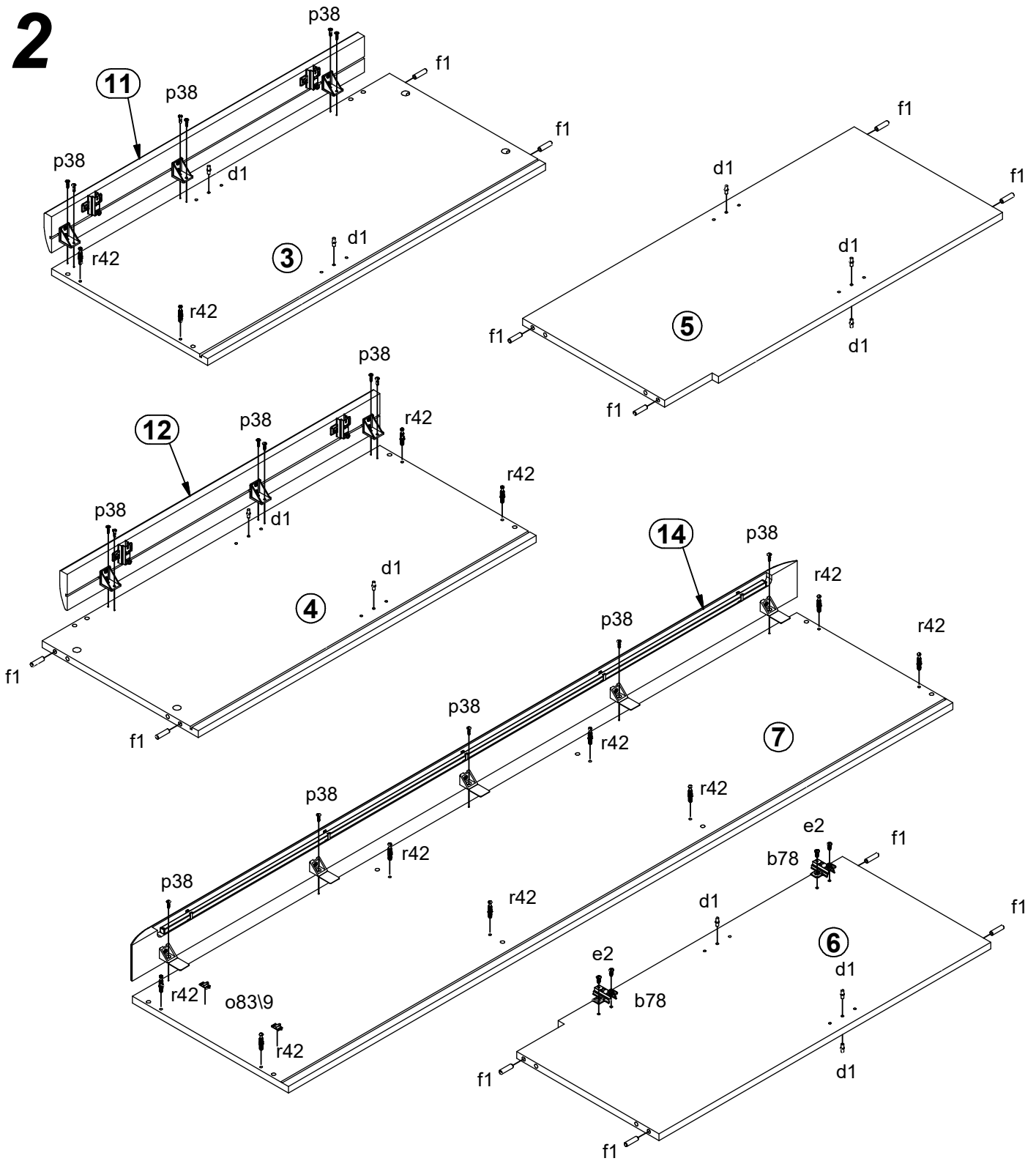

3

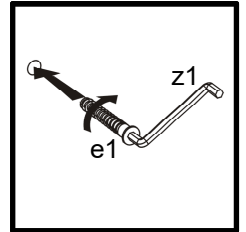
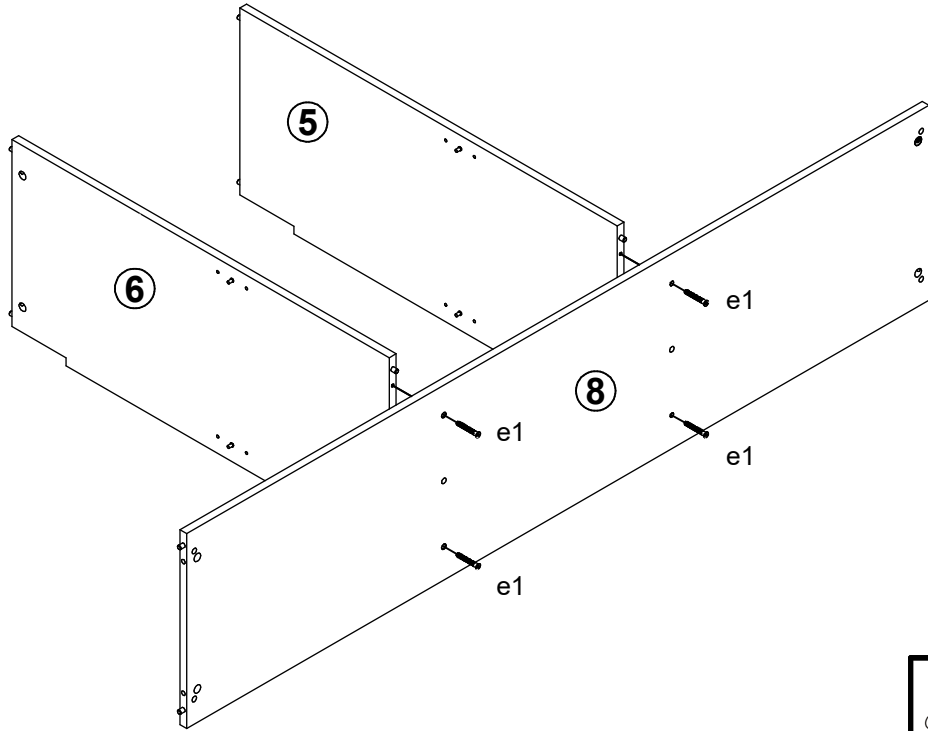

4

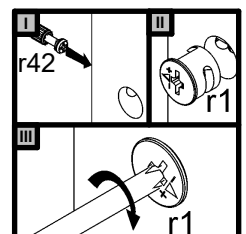
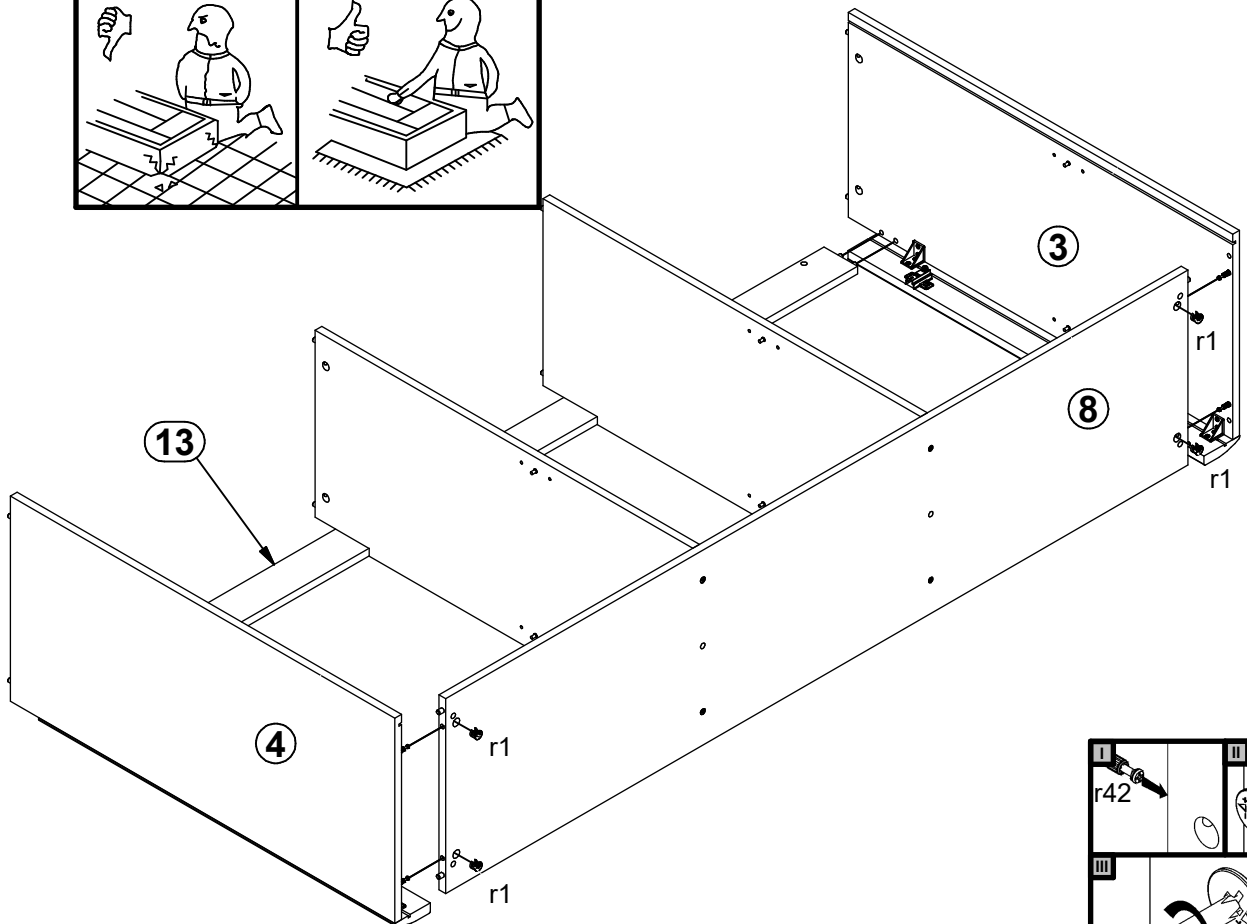
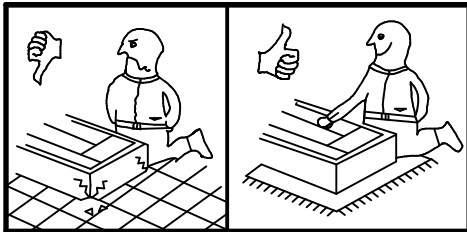

5

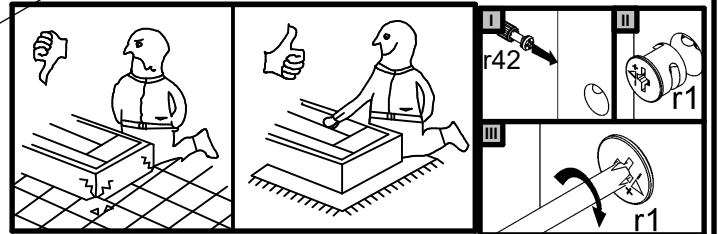
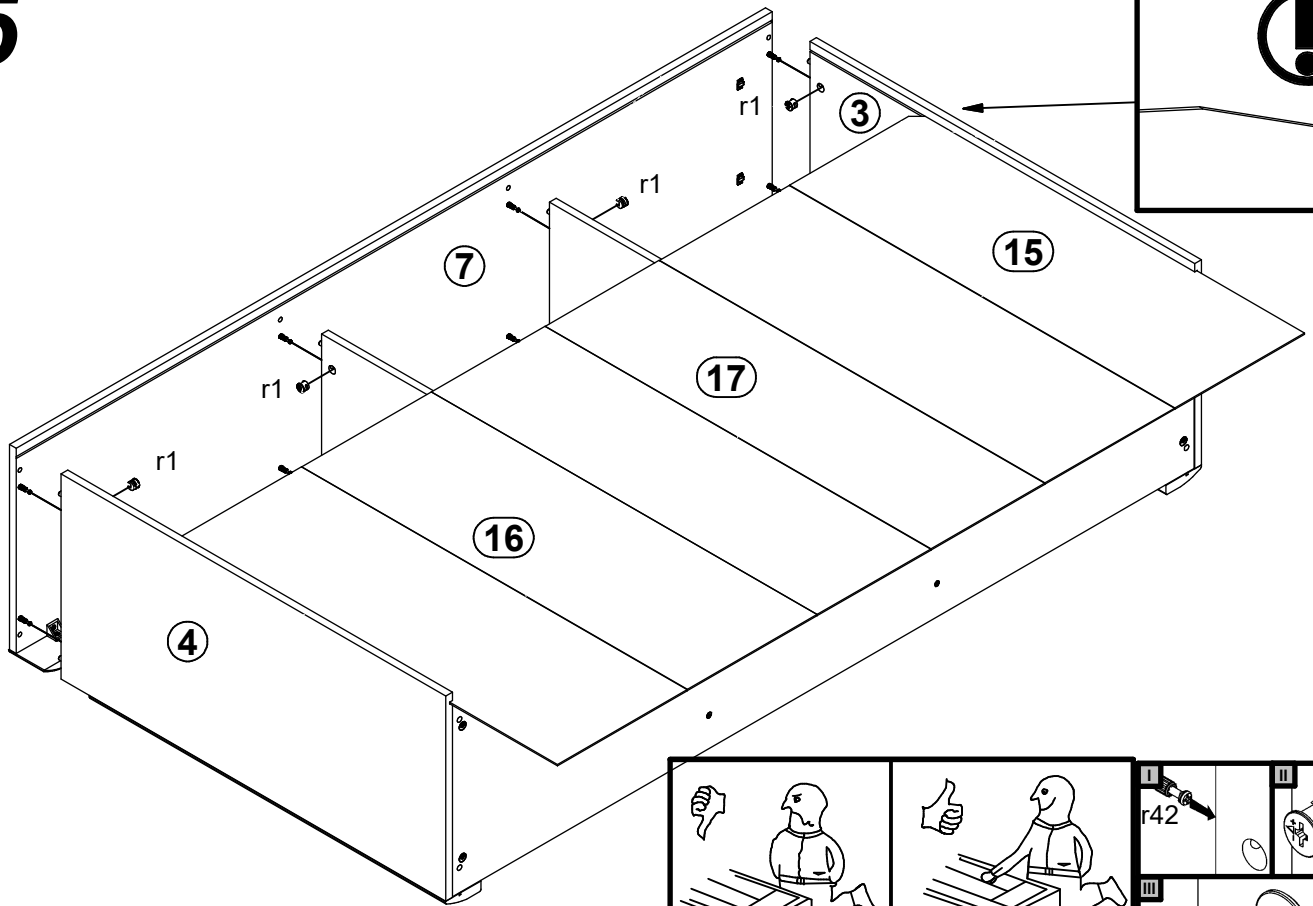

6

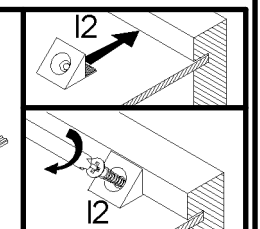
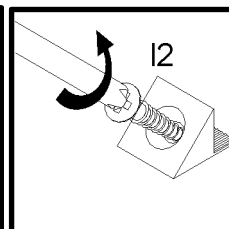
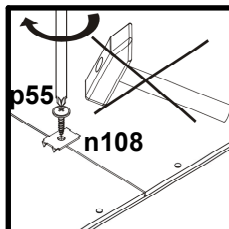
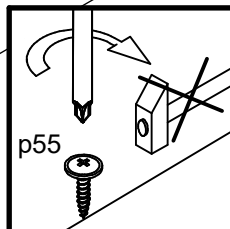
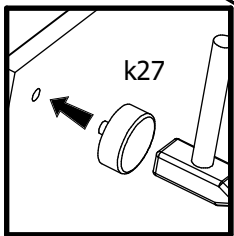
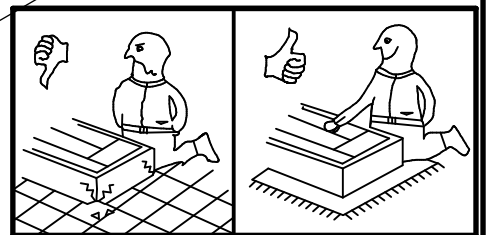
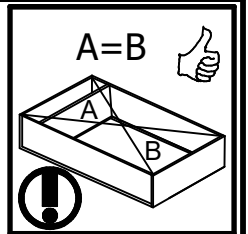
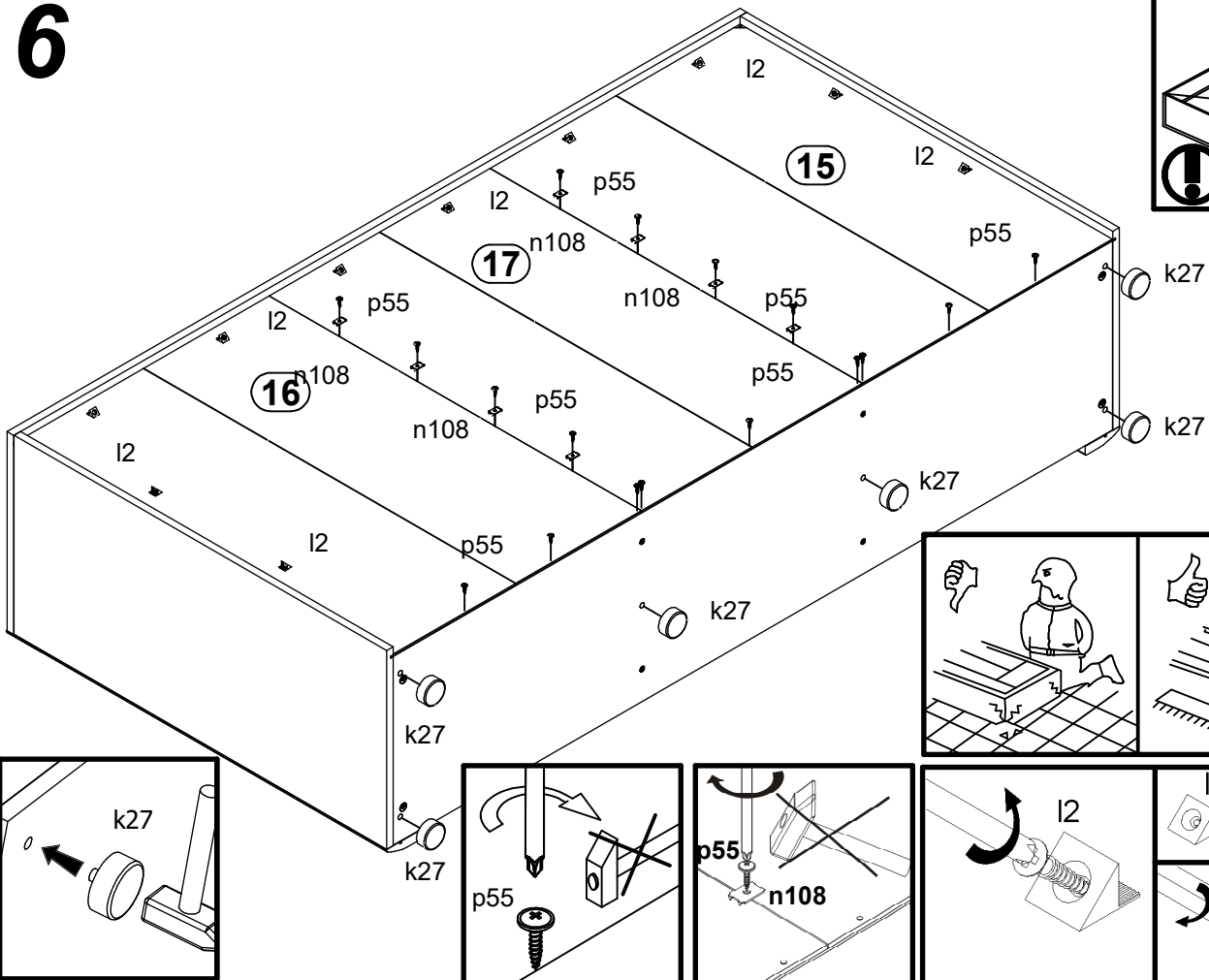

7

