

A	B	C	D	
1	S488-0004	758	509	3/3
2	S488-0007	509	200	3/3
3	S488-0008	509	200	3/3
4	S488-1007	2014	399	1/3
5	S488-1008	2014	399	1/3
6	S488-2003	674	399	2/3
7	S488-3006	643	379	2/3
8	S488-3007	642	373	2/3
9	S488-3008	643	379	2/3
10	S488-3011	642	373	2/3
11	S488-5001	807	508	3/3
12	S488-5002	641	360	2/3
13	S488-5507	643	75	2/3
14	S488-5508	676	80	1/3
15	S488-5509	1950	80	1/3
16	S488-5510	1950	80	1/3
17	S488-9306	2016	653	1/3

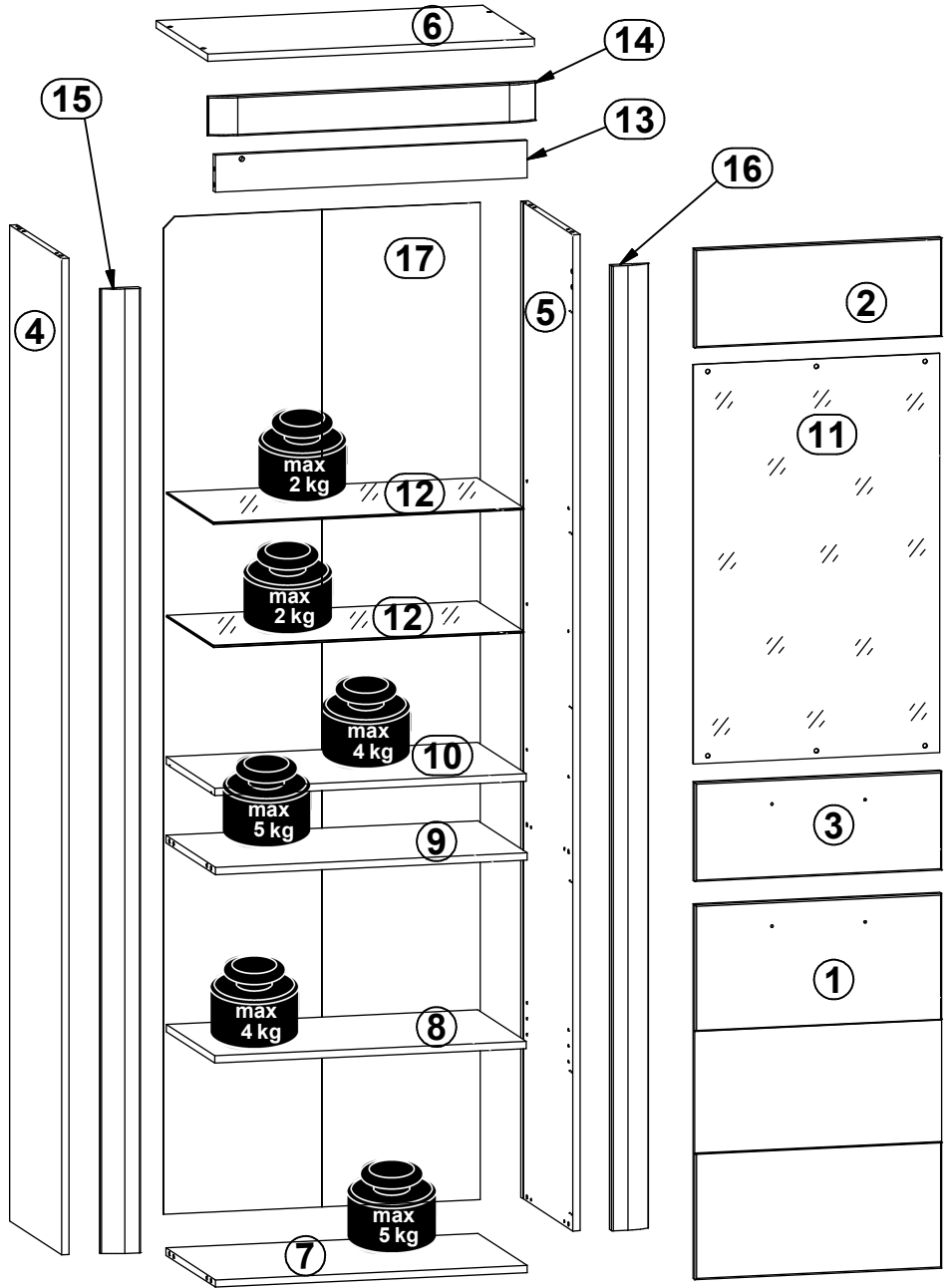

4x  a132	2x  a133	4x  b43	2x  c34213 192 mm	8x  d1 Ø5x17 mm	8x  d3 Ø5x17 mm	3x  d36	12x  d37	4x  e1 Ø7x50 mm	
8x  e2 Ø6.3x13 mm	6x  e47 Ø5x16 mm	16x  f1 Ø8x30 mm	4x  j30 M4x22 mm	4x  k27	11x  l2	6x  o54 Ø5.3/Ø6.3x4.8 mm	1x  o7019 1P 6W	2x  o7716	
1x  o77161 10x10 mm L=525 mm	2x  p15 Ø2.5x13 mm	54x  p38 Ø3.5x16 mm	8x  p51 Ø3.5x15 mm	8x  p55 Ø2.9x16 mm	8x  r1 Ø15x12 mm #16	8x  r42 20/11	2x  o8319 15x15 mm	1x  z1 4 mm	
1x  n1412 89x21x151.5	1x  f35 Ø10x50 mm	1x  p17 Ø5x60 mm	2x  p38 Ø3.5x16 mm						

1 

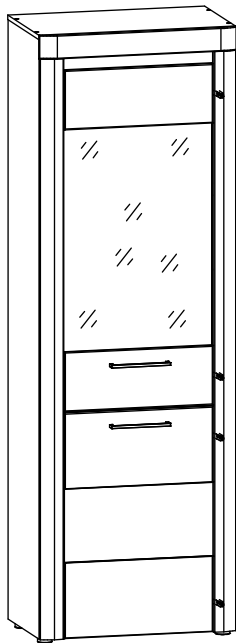
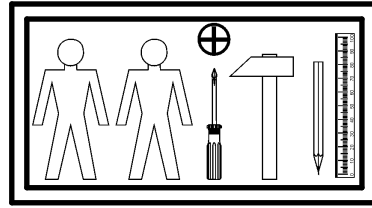
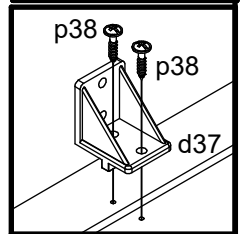
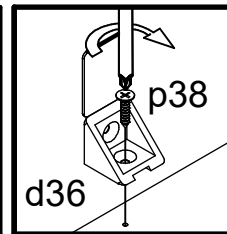
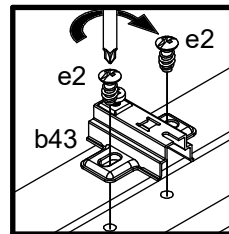
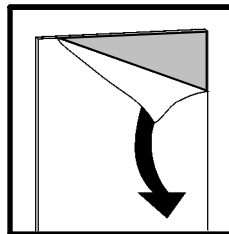
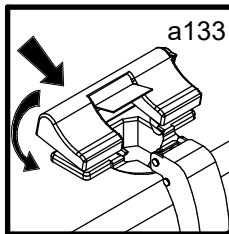
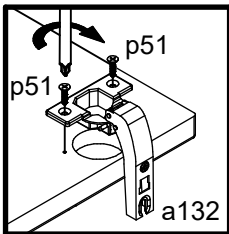
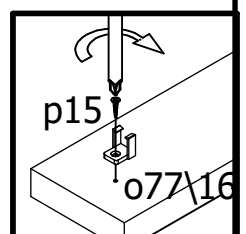
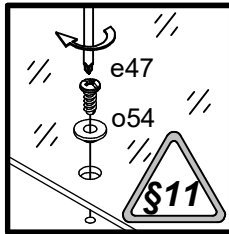
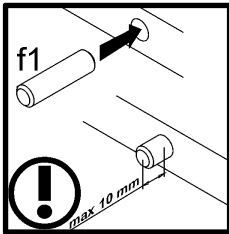
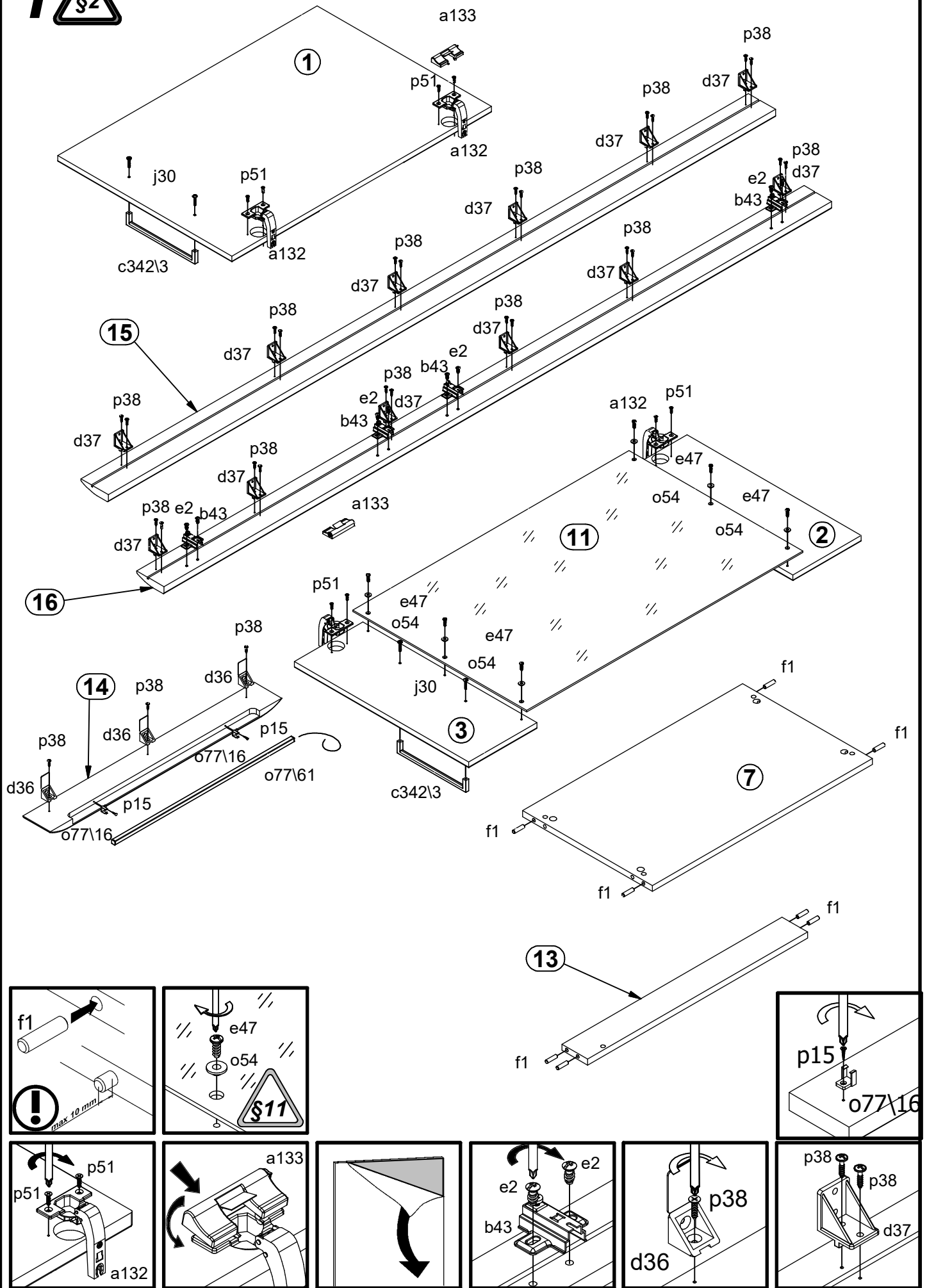

# 2

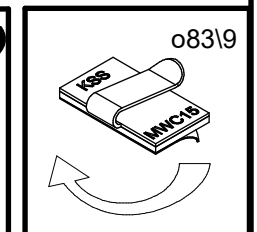
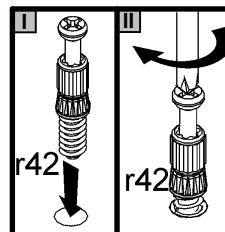
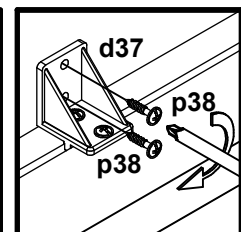
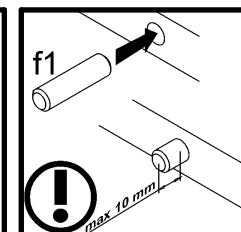
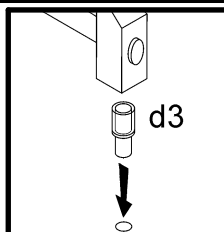
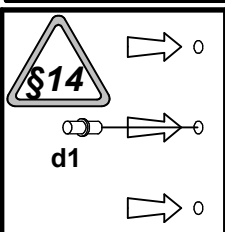
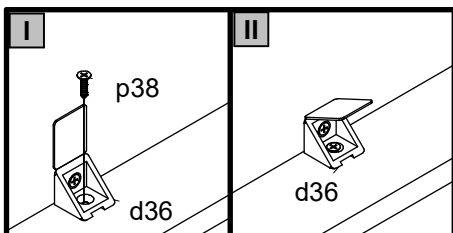
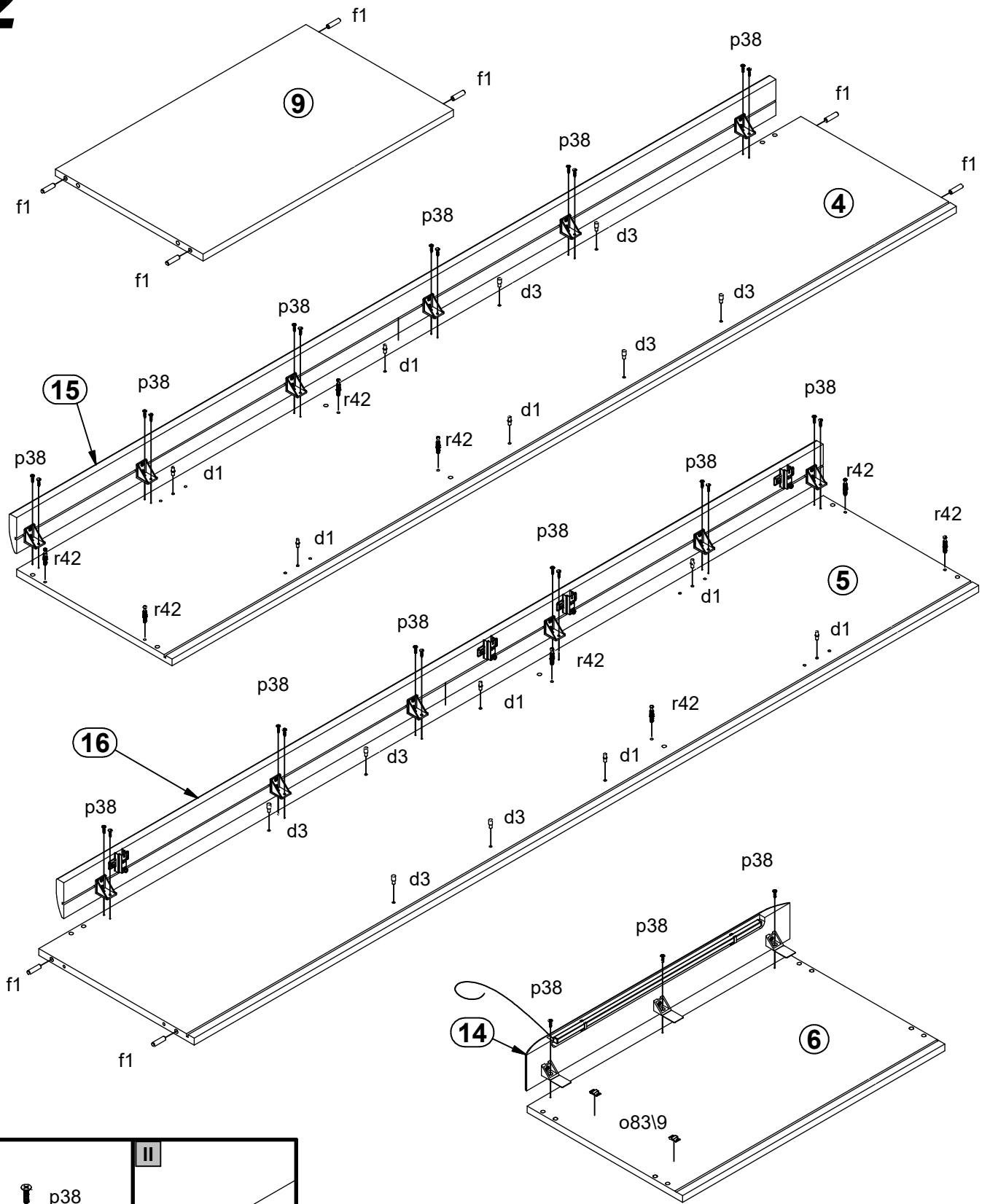

# 3

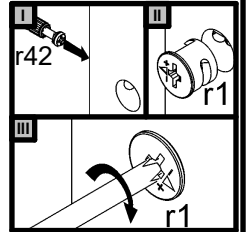
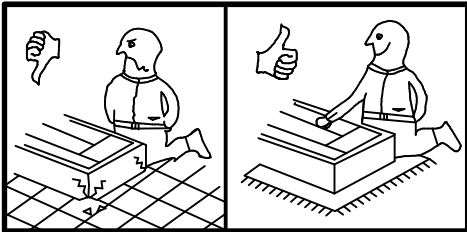
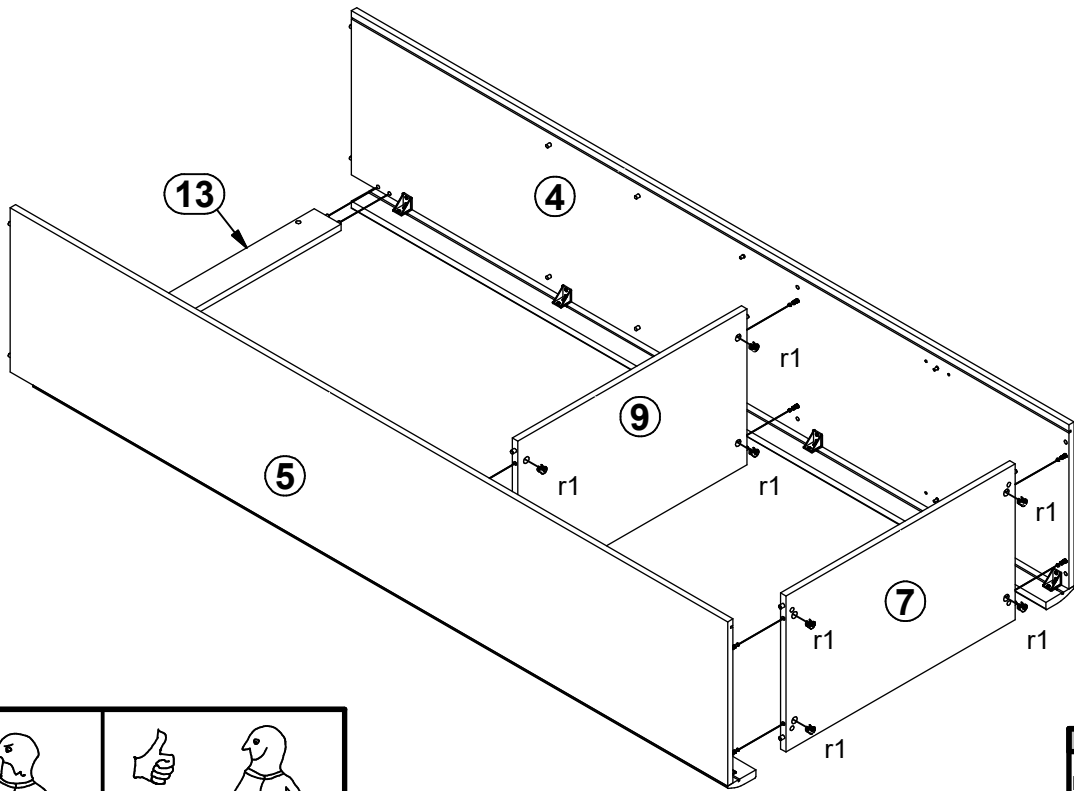

# 4

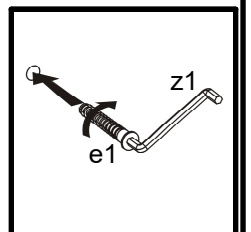
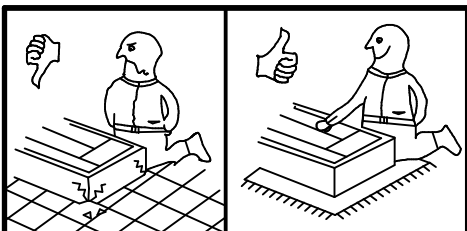
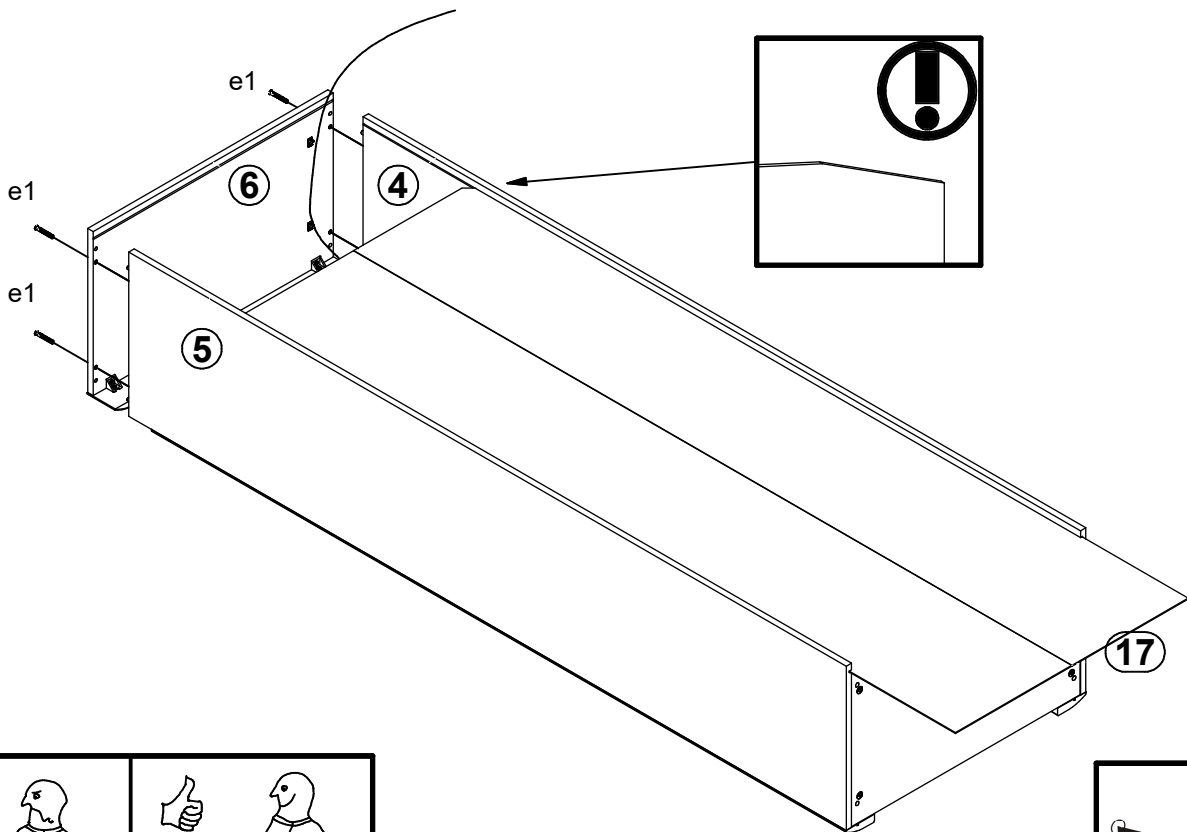

# 5 <sup>17</sup>

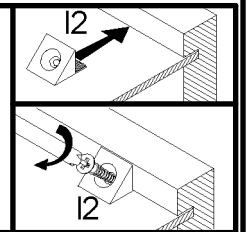
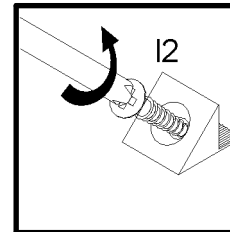
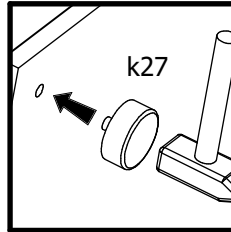
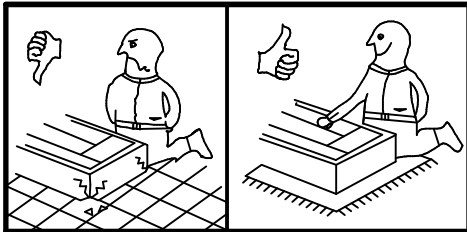
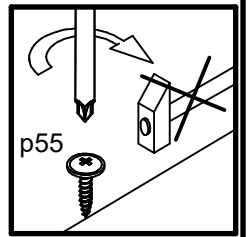
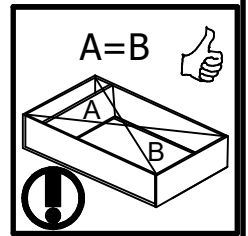
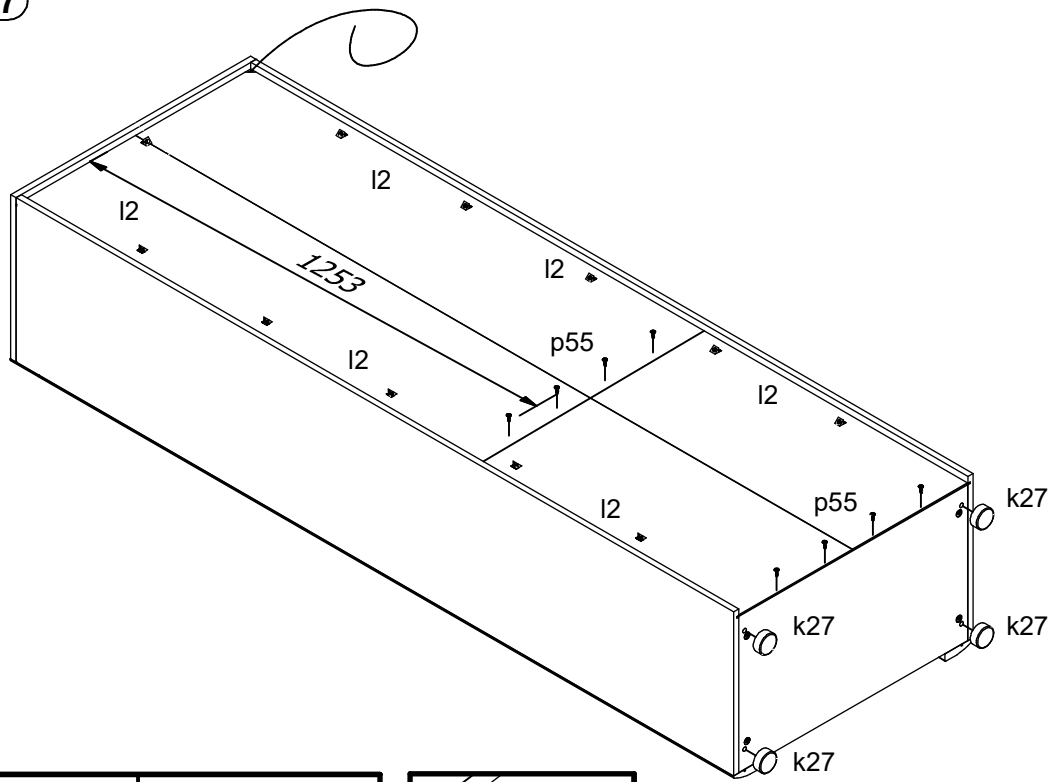

# 6

