

A	B	C	D	
1	S488-0003	758	509	3/3
2	S488-0004	758	509	3/3
3	S488-0007	509	200	3/3
4	S488-0008	509	200	3/3
5	S488-0011	509	200	3/3
6	S488-0012	509	200	3/3
7	S488-1016	1626	399	1/3
8	S488-1017	1626	399	1/3
9	S488-1018	1610	379	1/3
10	S488-2005	1186	399	2/3
11	S488-3012	1155	379	2/3
12	S488-3013	570	379	2/3
13	S488-3014	570	379	2/3
14	S488-3015	569	373	2/3
15	S488-5003	418	499	3/3
16	S488-5004	568	360	2/3
17	S488-5516	1155	75	1/3
18	S488-5517	1188	80	1/3
19	S488-5518	1562	80	1/3
20	S488-5519	1562	80	1/3
21	S488-9308	1628	583	1/3
22	S488-9309	1628	583	1/3

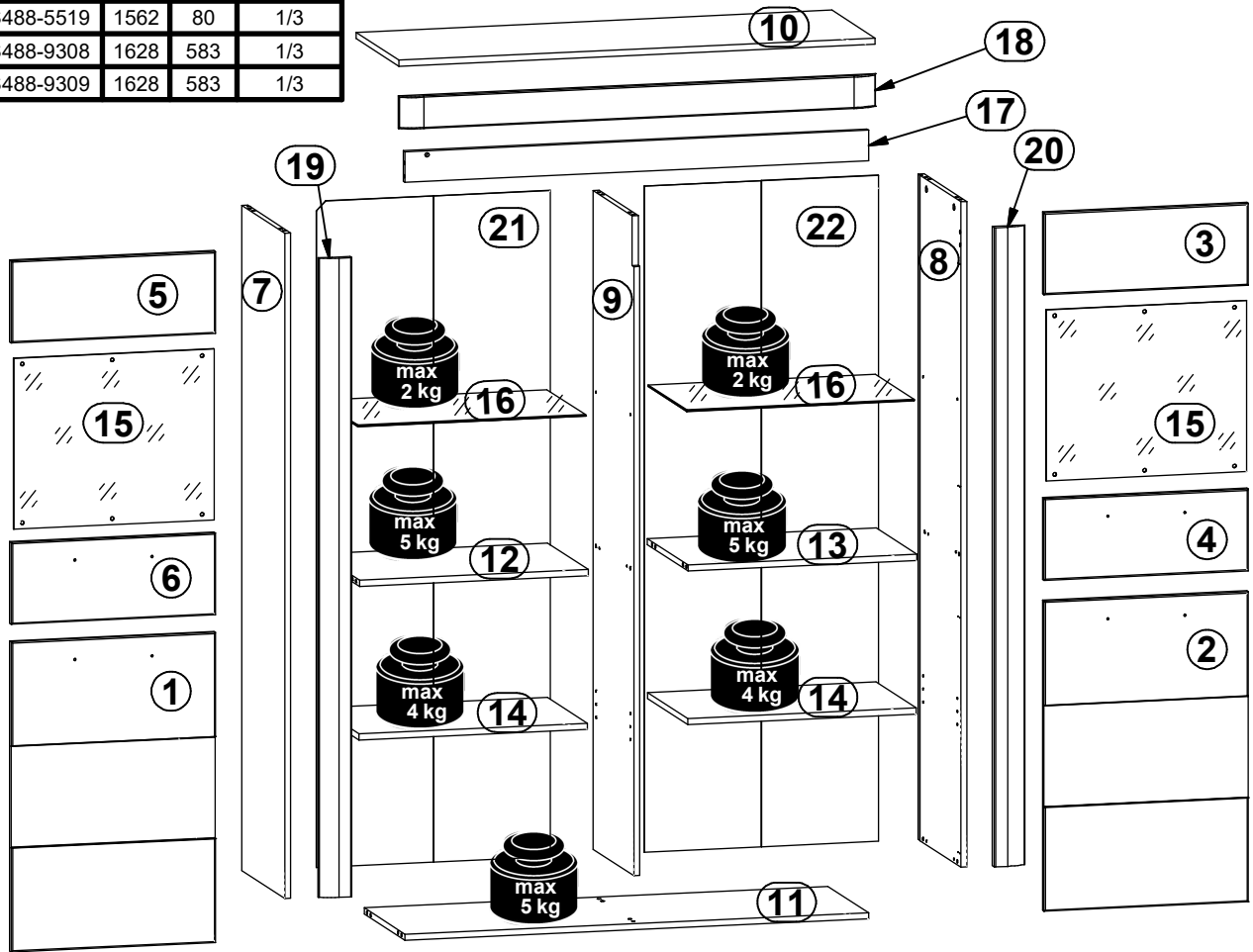

8x  a132	4x  a133	8x  b43	4x  c342/3	8x  d1	8x  d3	4x  d36	8x  d37	2x  e1
16x  e2	12x  e47	24x  f1	8x  j30	5x  k27	10x  l2	8x  n108	12x  o54	3x  o77/16
2x  o83/9	1x  o70/9	1x  o77/62	3x  p15	40x  p38	16x  p51	20x  p55	18x  r1	18x  r42
6x  s68	1x  z1	1x  n26/1	1x  p38					

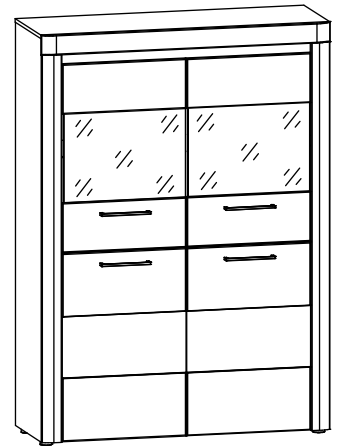
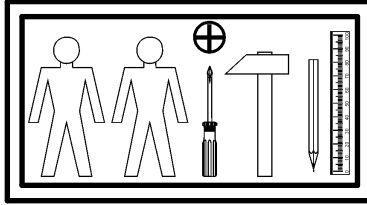
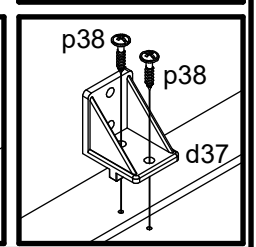
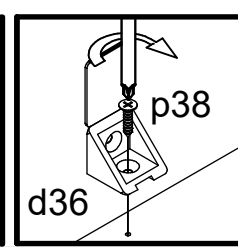
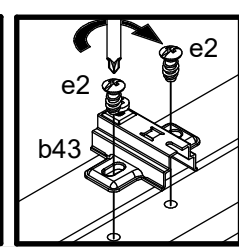
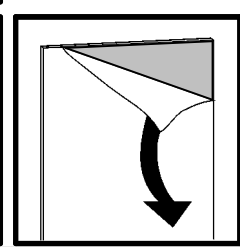
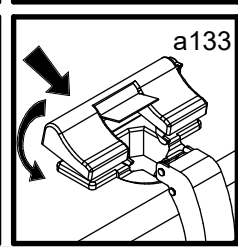
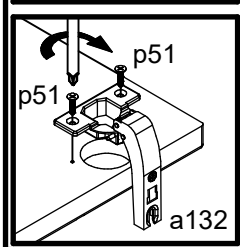
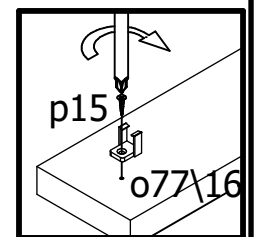
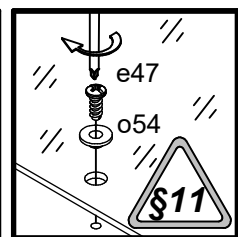
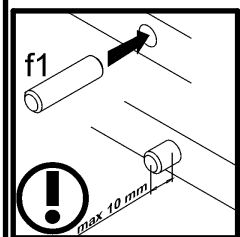
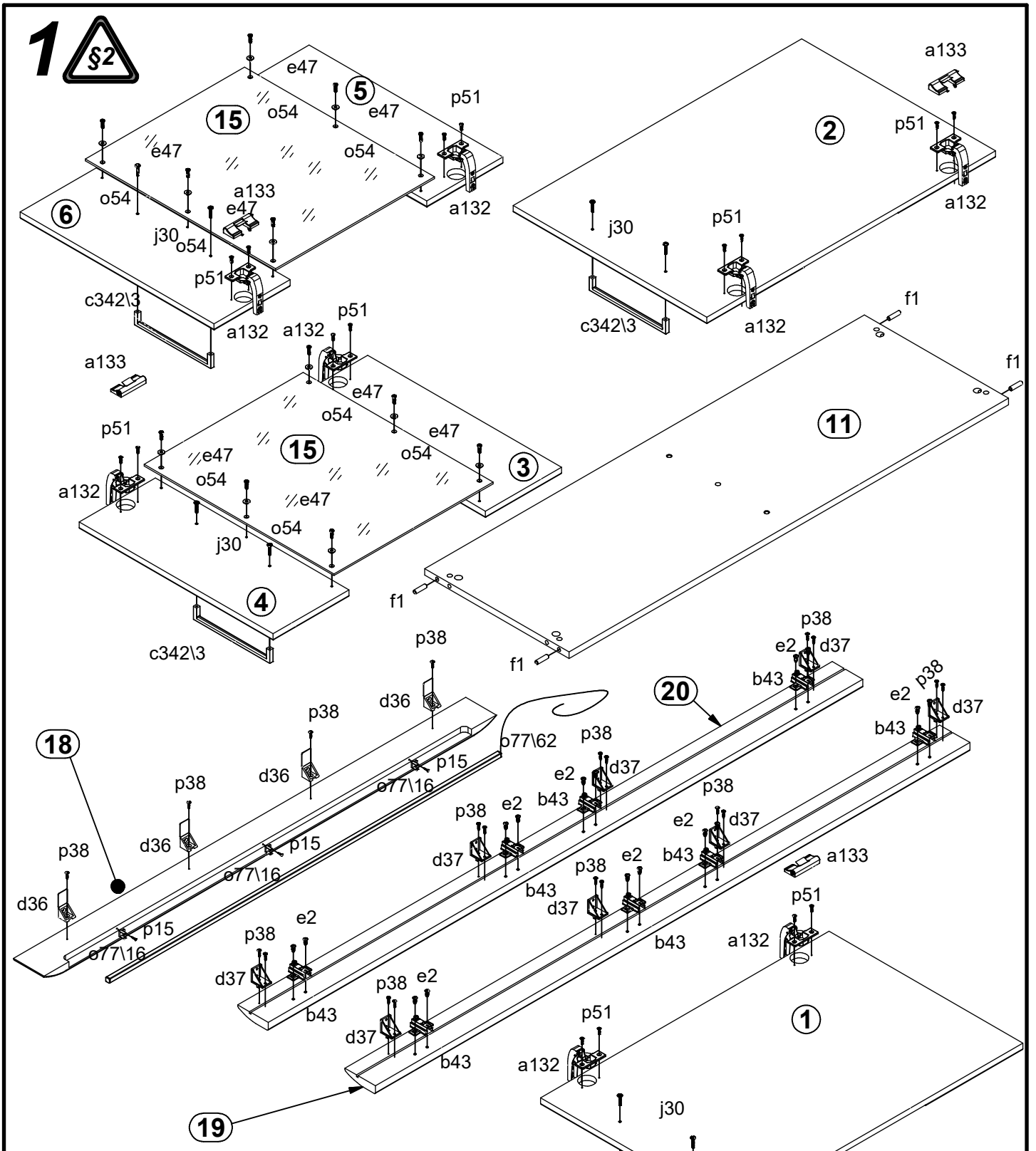

# 2

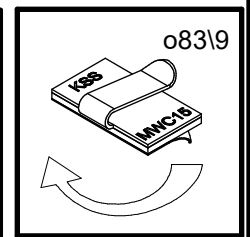
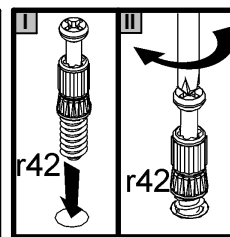
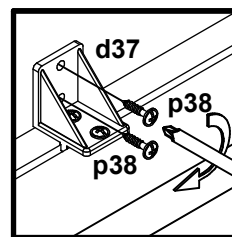
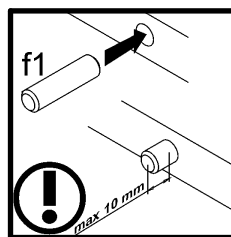
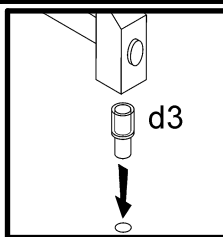
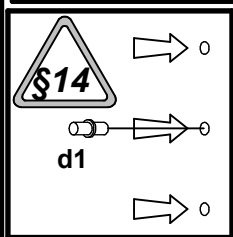
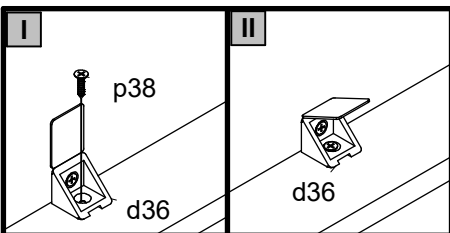
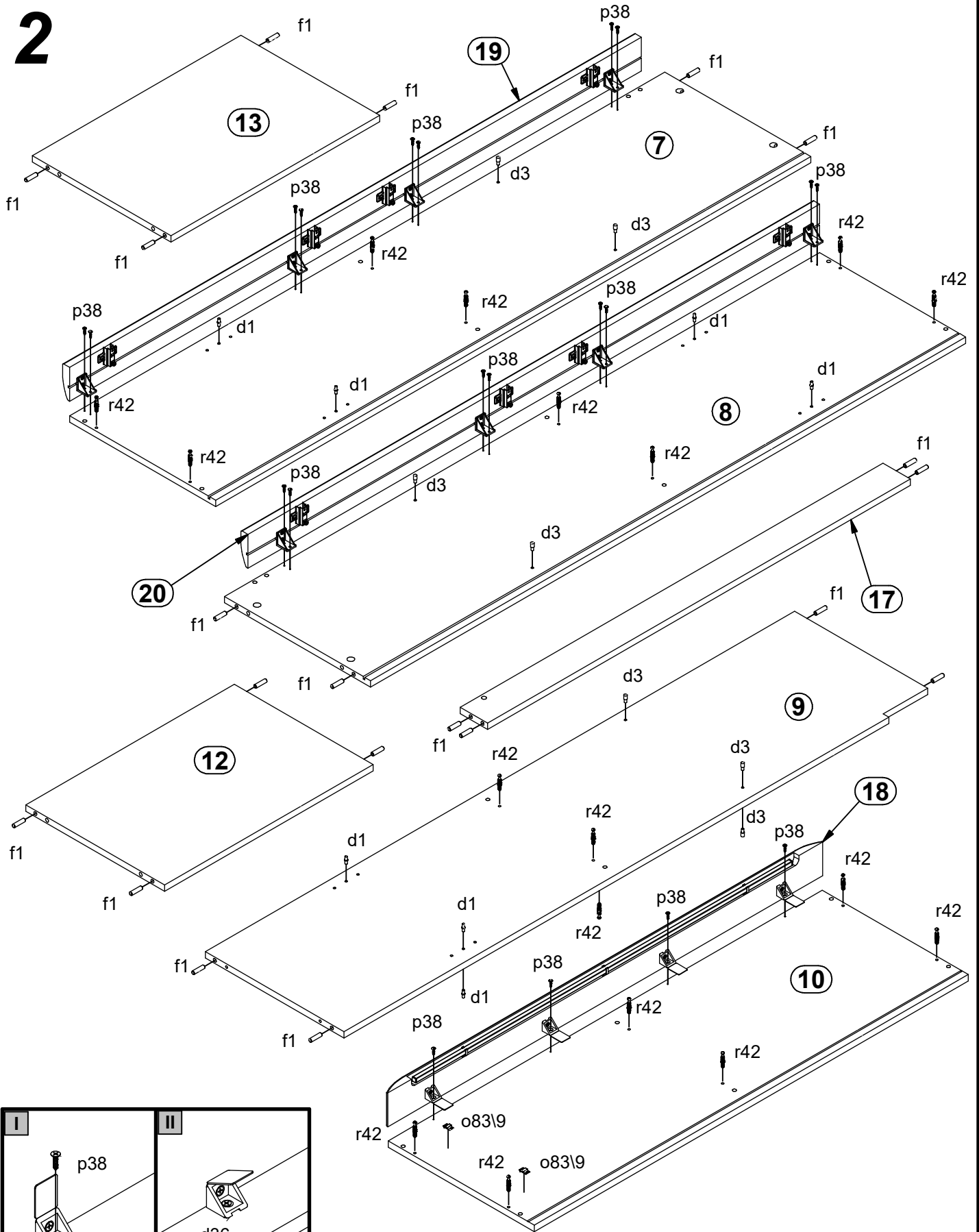

# 3

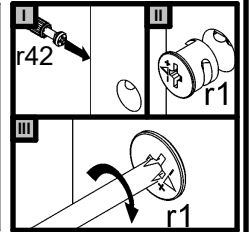
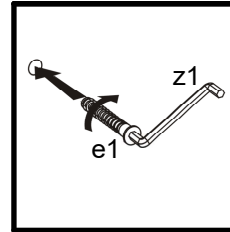
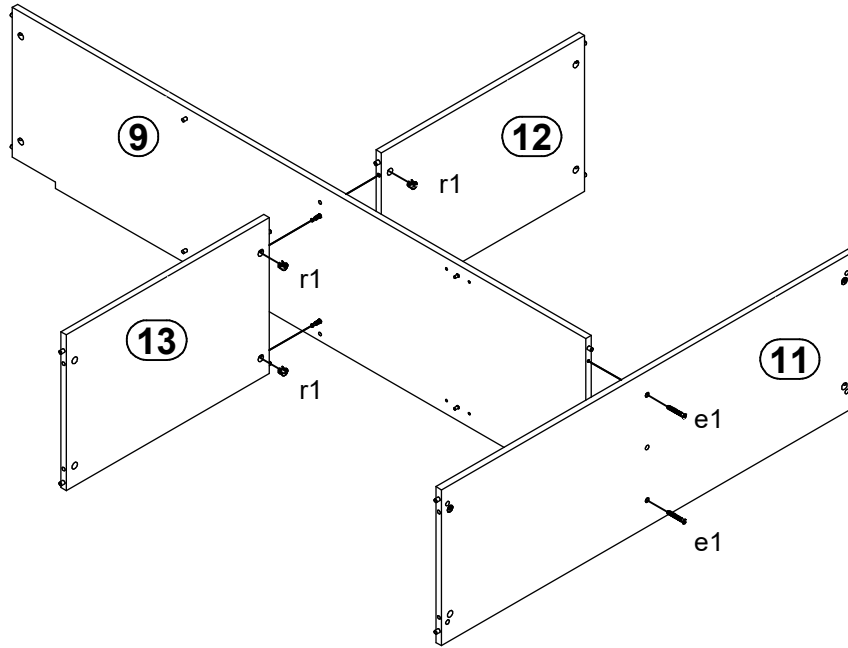

# 4

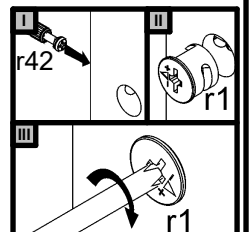
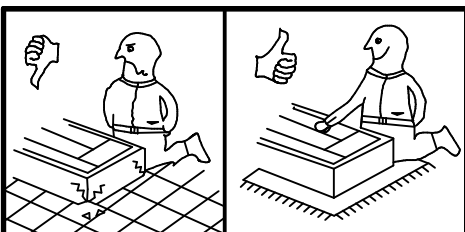
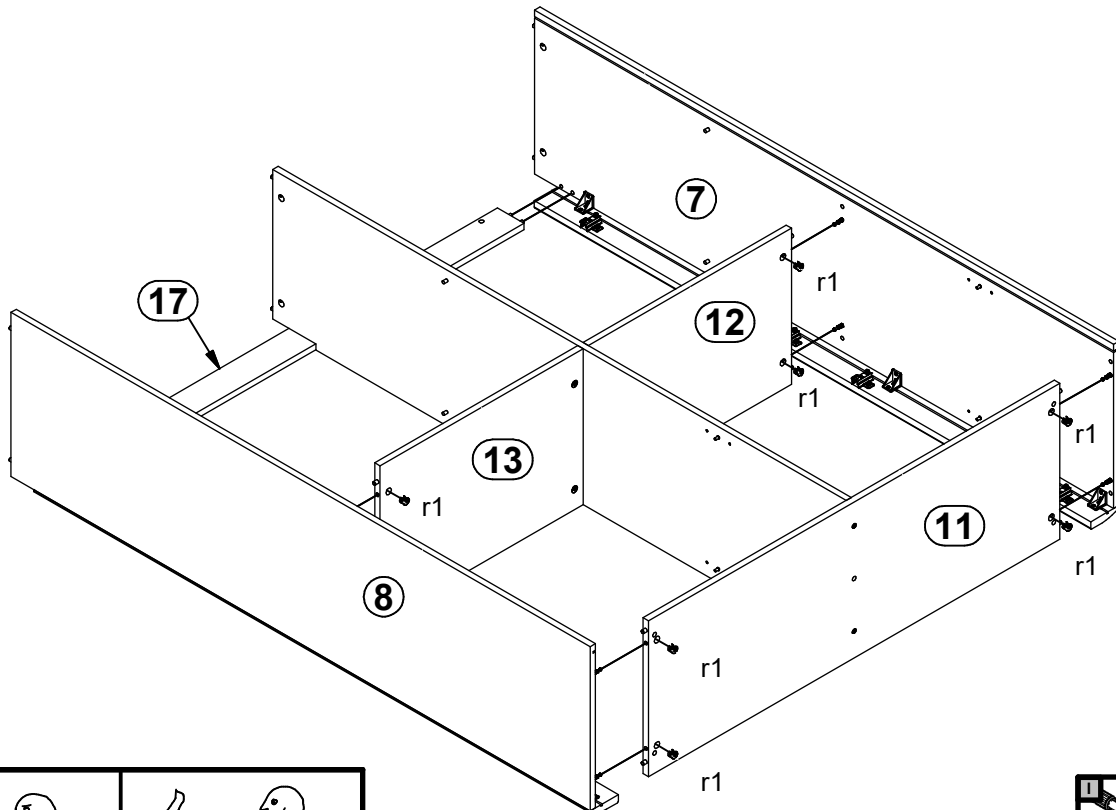

# 5

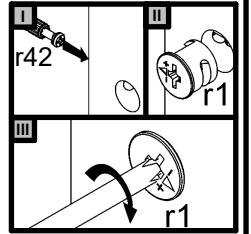
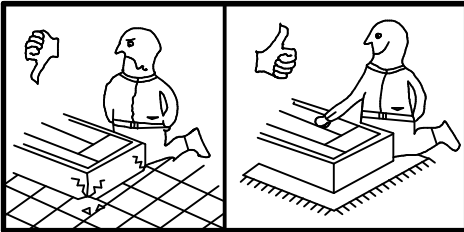
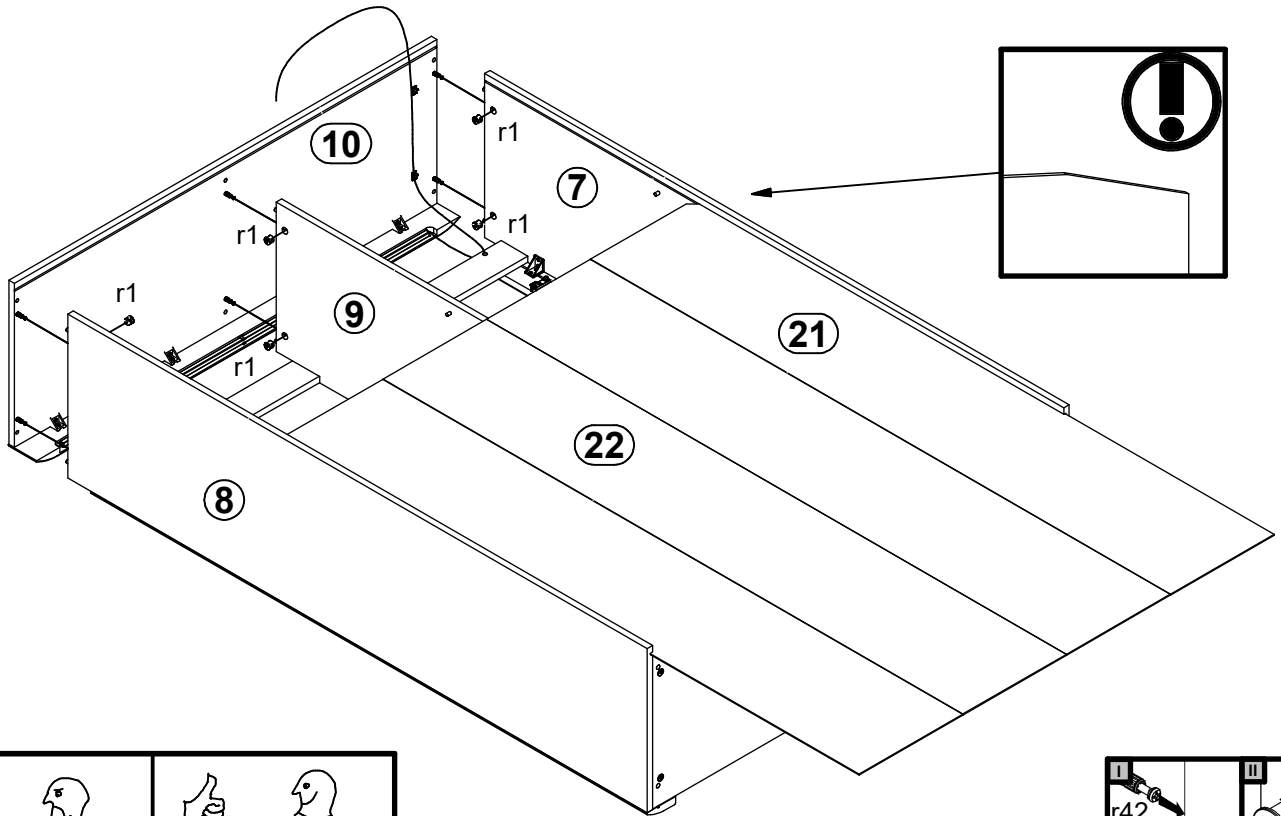

# 6

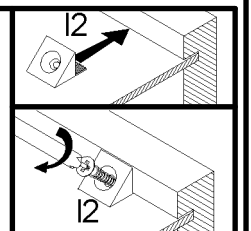
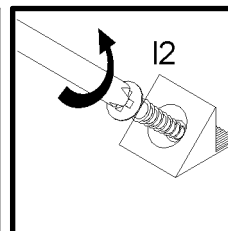
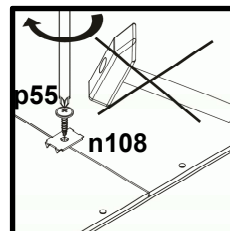
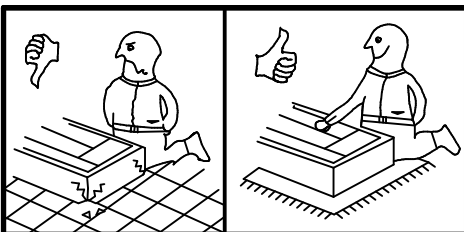
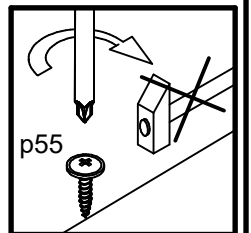
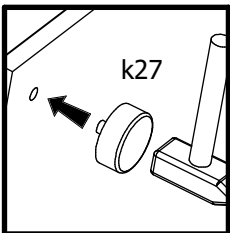
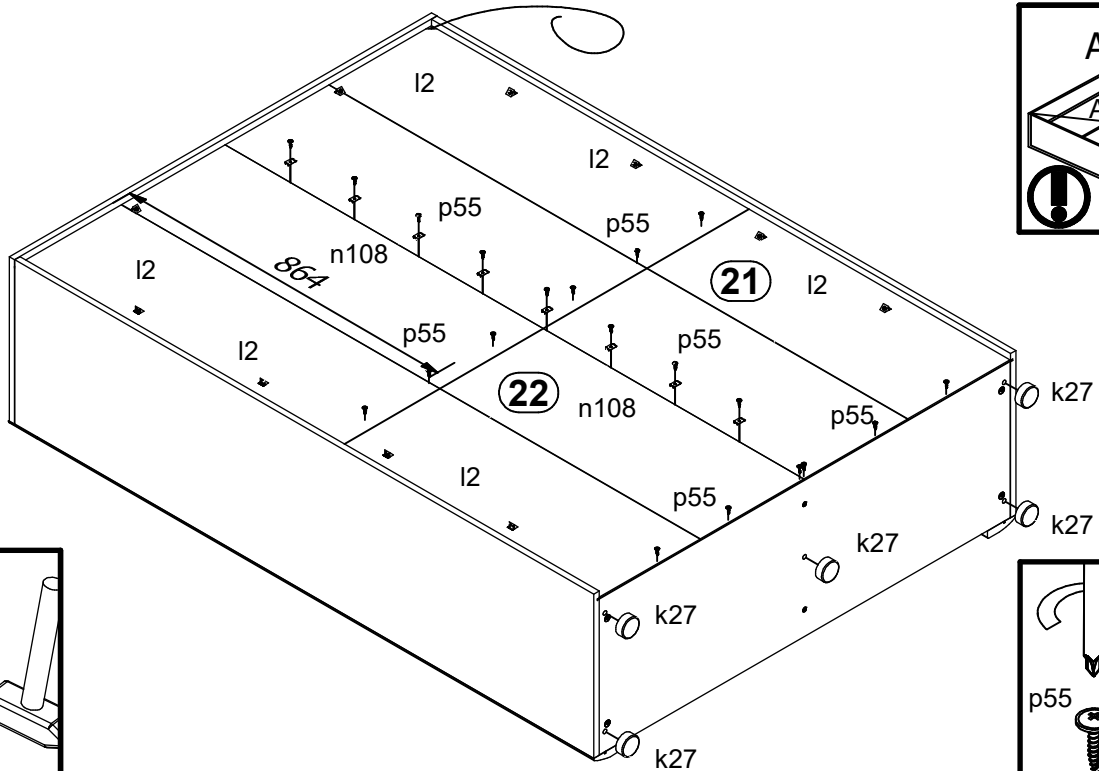

# 7

