

A	B	C (mm)			D
1	S610-0003	696	296	15	1/1
2	S610-1005	670	299	15	1/1
3	S610-1006	670	299	15	1/1
4	S610-2005	600	300	15	1/1
5	S610-2006	600	300	15	1/1
6	S610-3004	568	293	15	1/1
7	S610-9304	695	595	2,5	1/1

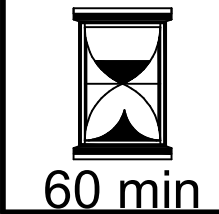
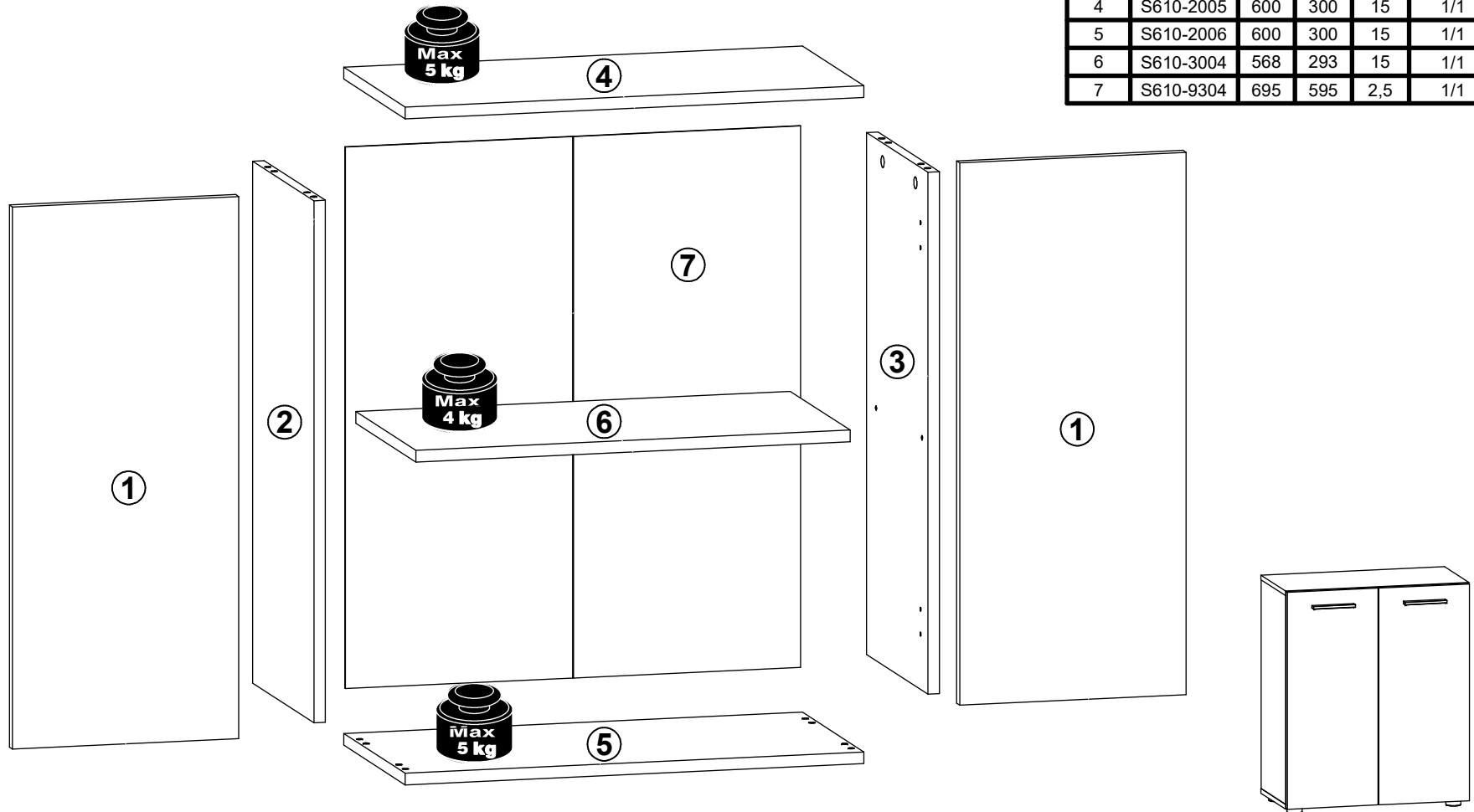

cm 0 1 2 3 4 5 6 7 8 9 10

4x a83	4x b32	2x c310 128 mm	4x d1 Ø5x17 mm	4x e1 Ø7x50 mm	8x f1 Ø8x30 mm	4x k27	25x l1 1,4x20 mm	1x n26	1x p38 Ø3,5x16 mm	8x p51 Ø3,5x15 mm	4x p87 Ø4x25 mm	4x r1 Ø15x12 mm #16	4x r42 20/11	4x s2 Ø16	1x z1 4 mm
---------	---------	--------------------	--------------------	--------------------	--------------------	---------	----------------------	---------	-----------------------	-----------------------	---------------------	-------------------------	------------------	---------------	----------------

D
1/1

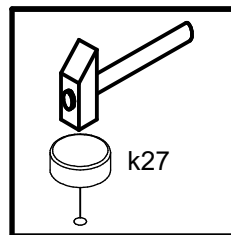
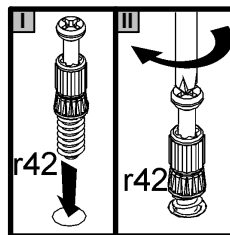
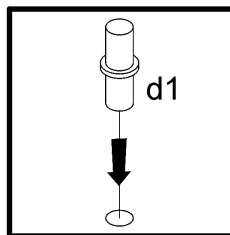
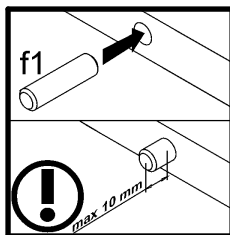
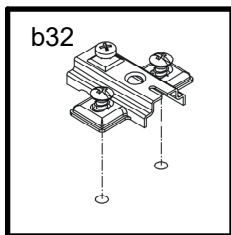
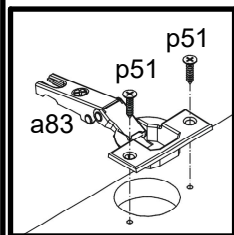
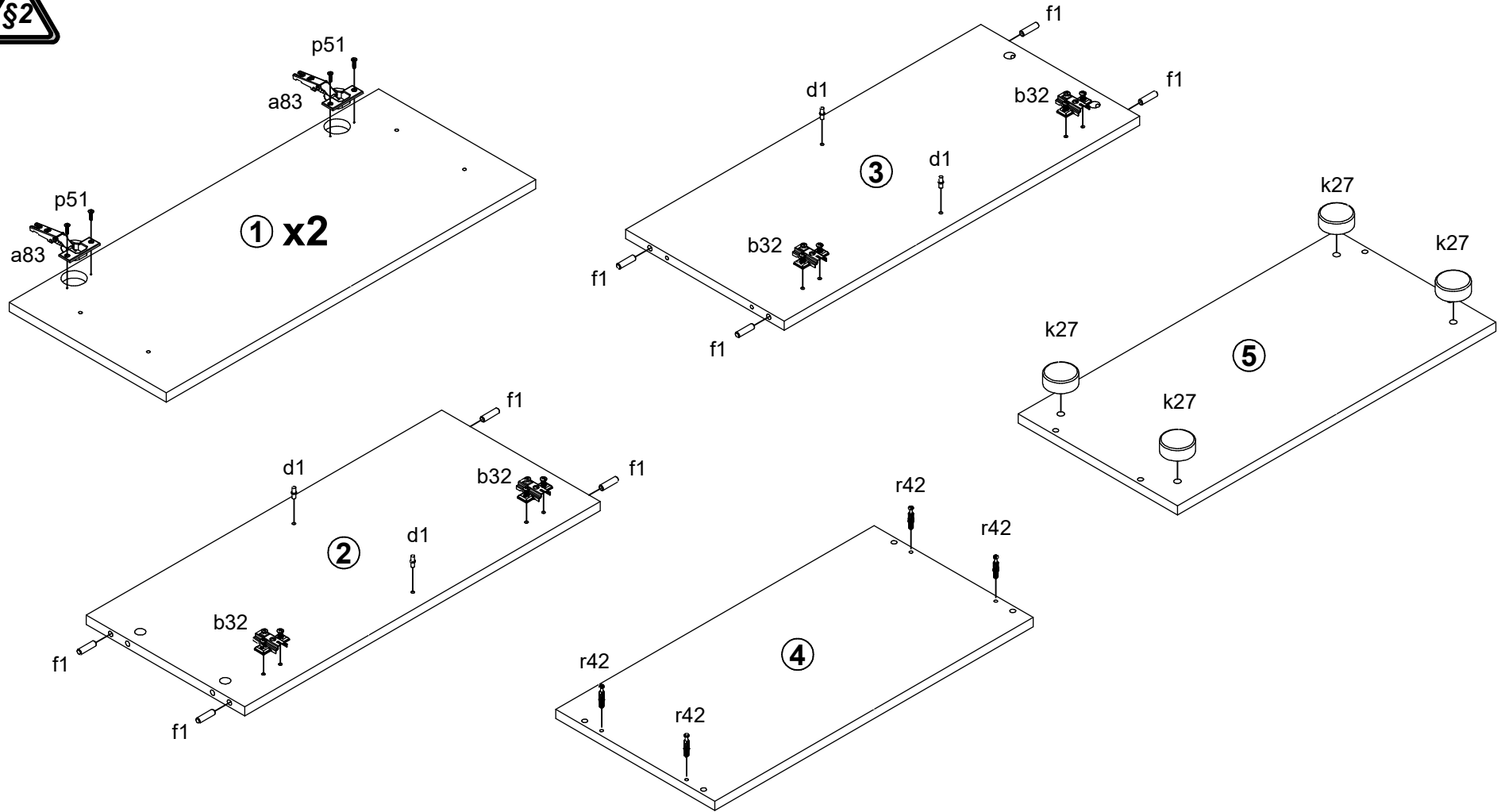

8x Ø8x30 mm f1	4x a83	4x b32	4x Ø5x17 mm d1
4x k27	8x Ø3,5x15 mm p51	4x r42	

2 

I

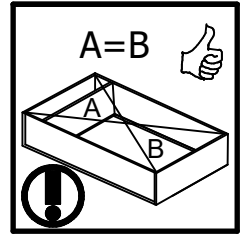
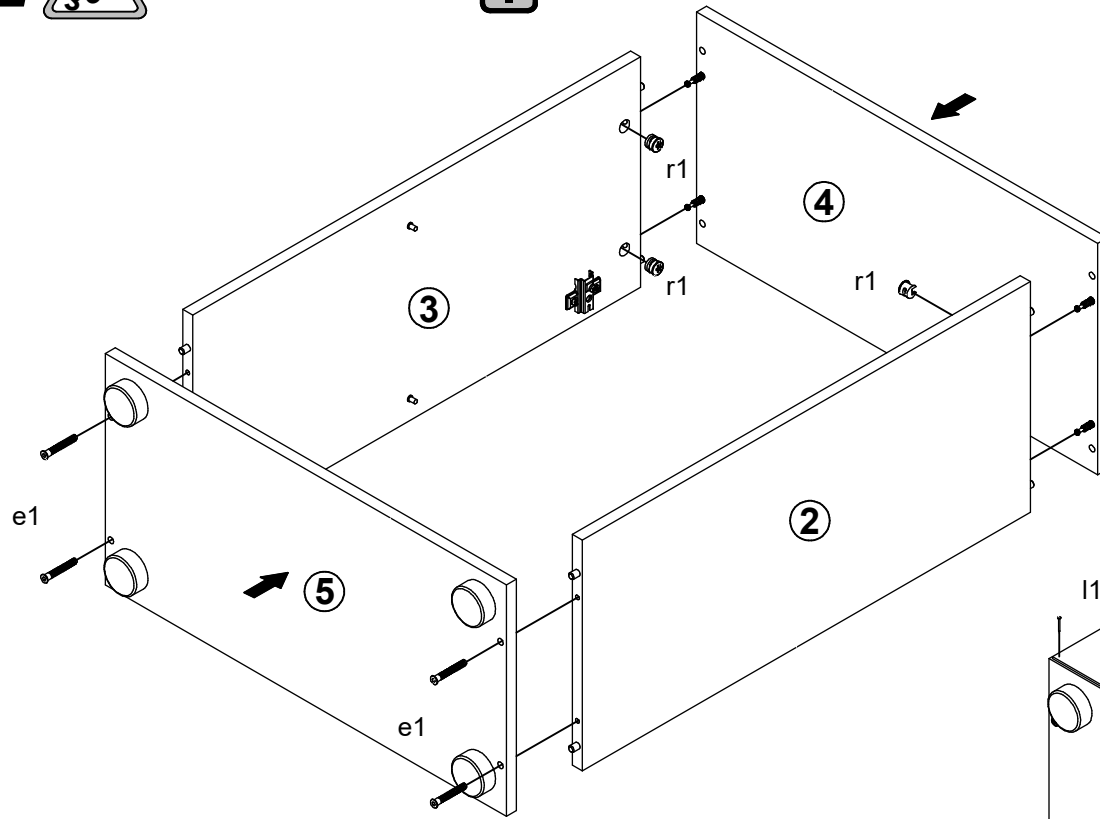

II

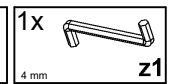
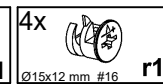
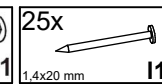
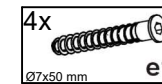
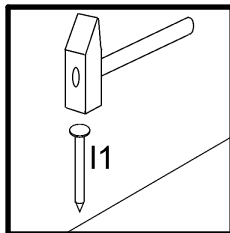
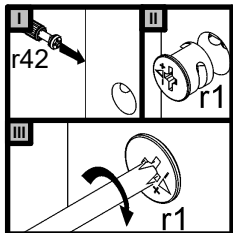
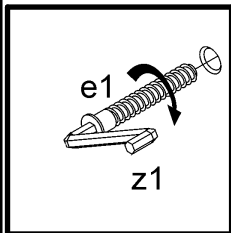
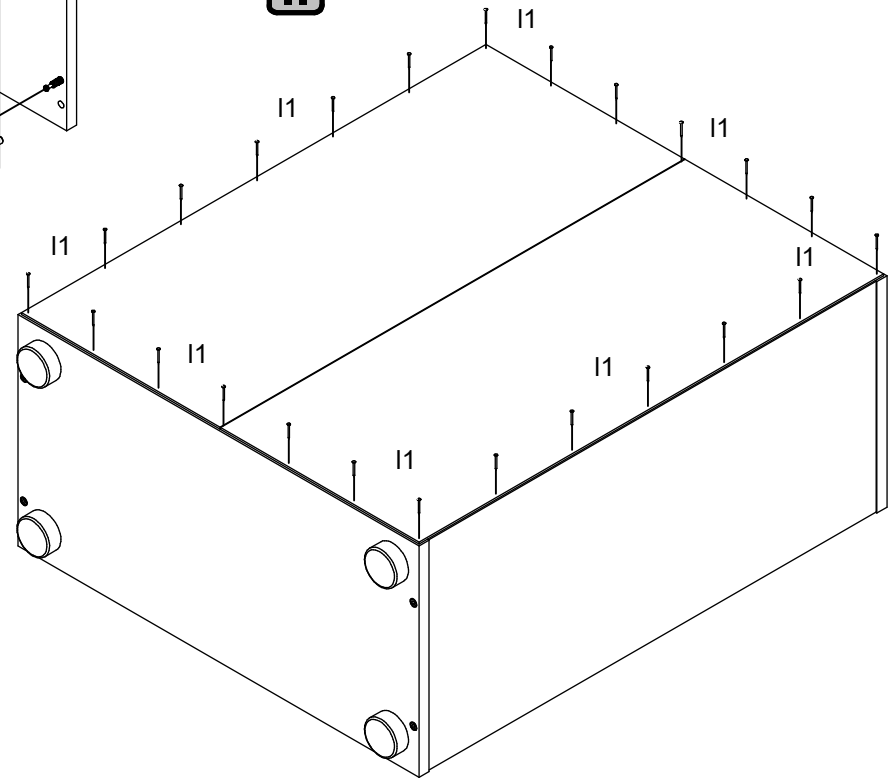

3 §6

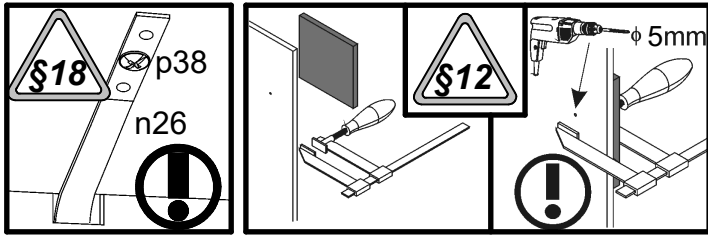

4

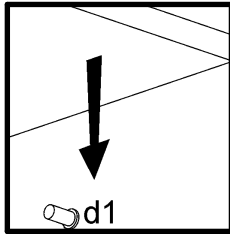
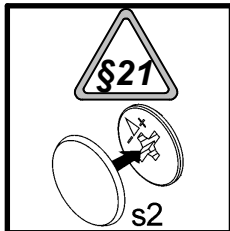
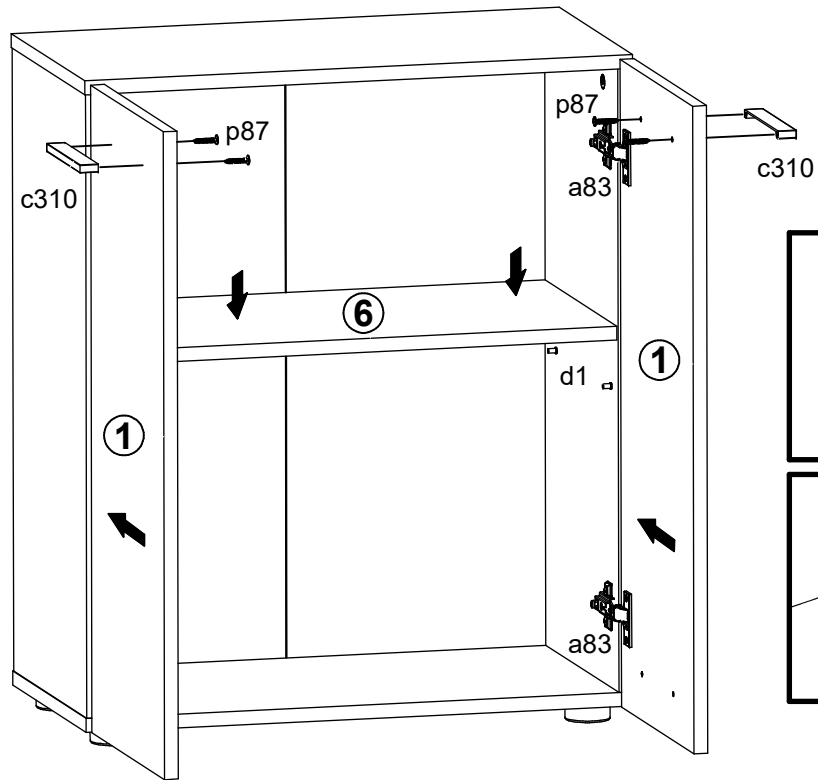

2x 128 mm c310

1x n26

1x Ø3.5x16 mm p38

4x Ø4x25 mm p87

4x Ø16 s2

