

A**S632-SZF2D****LAMEA**

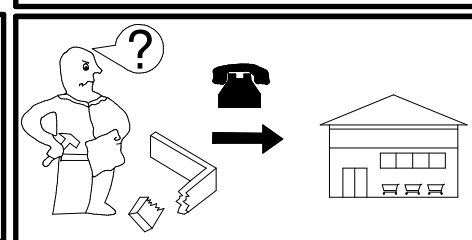

A	B1	B2	C1	C2	C3	D
1	S632-0014	-1	1788	357	16	2/3
2	S632-0019	-1	1788	499	16	2/3
3	S632-1023	-1	1794	549	16	1/3
4	S632-1024	-1	1794	549	16	1/3
5	S632-2018	-1	900	550	18	2/3
6	S632-2019	-2	900	550	18	2/3
7	S632-3015	-2	866	512	16	2/3
8	S632-9307	-2	1804	875	2,5	1/3
9	dr-858	-1	858	22	15	2/3

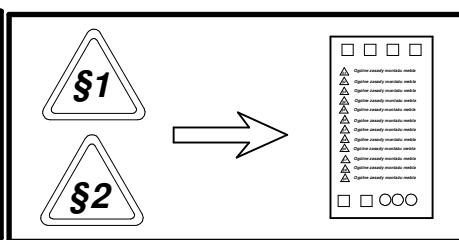

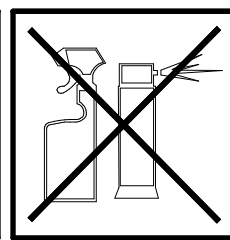
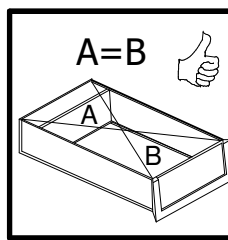
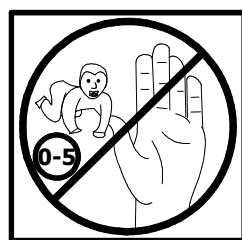
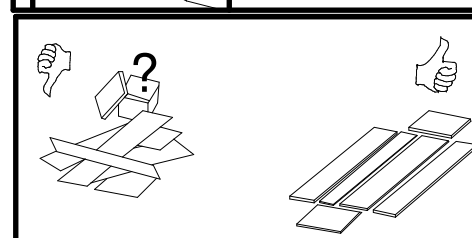
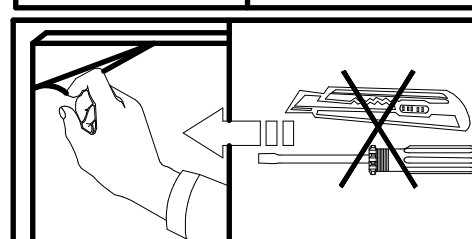
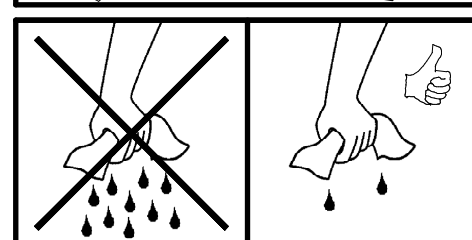
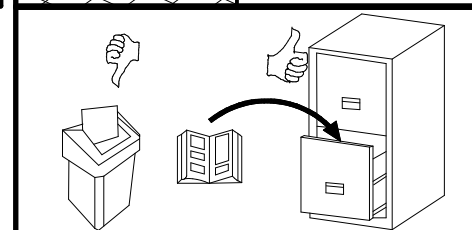
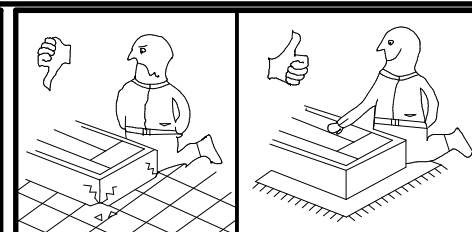
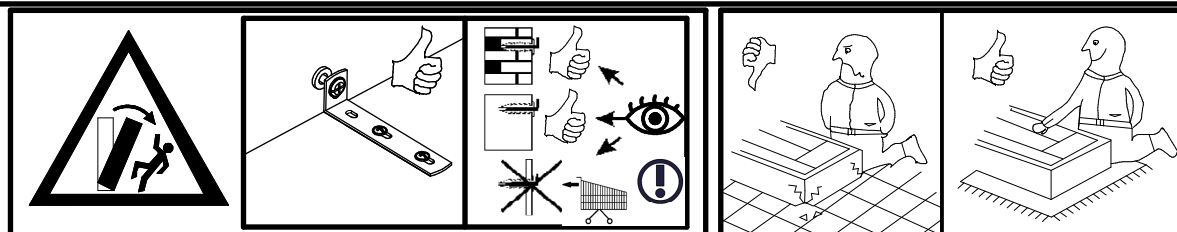
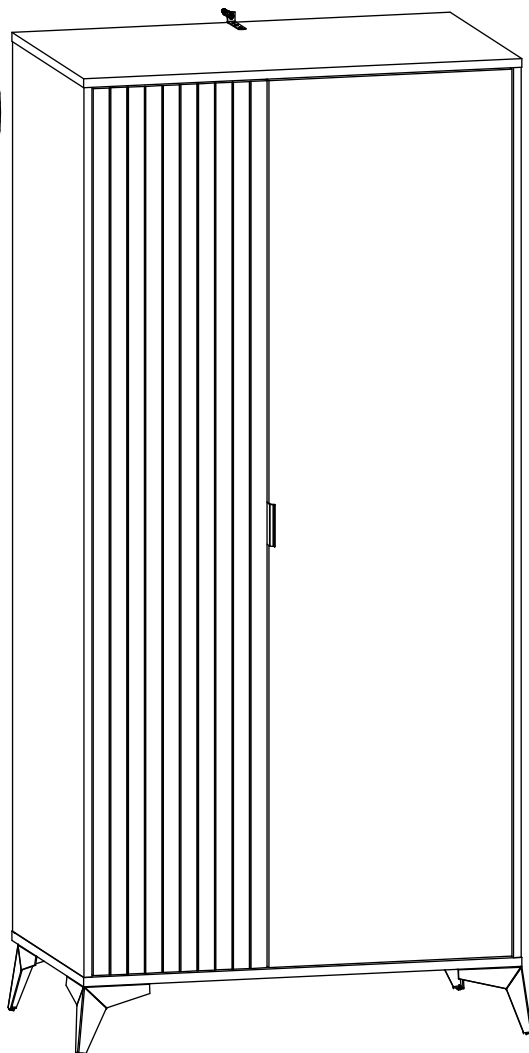
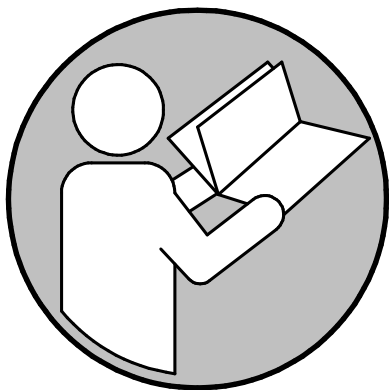
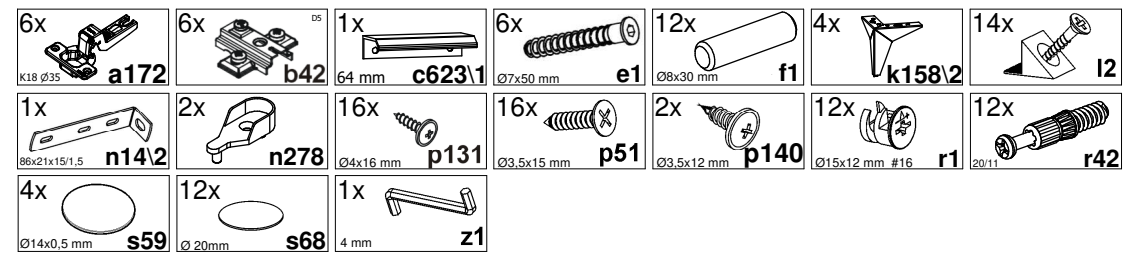
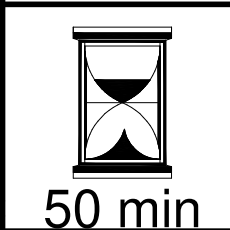
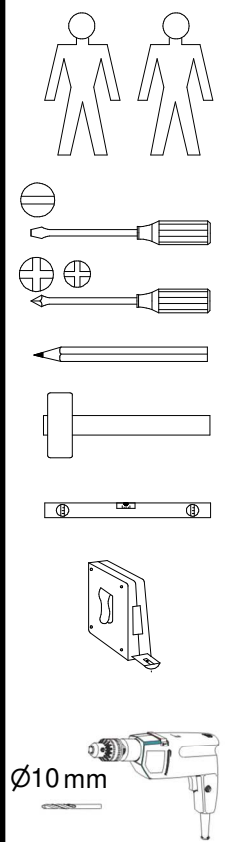
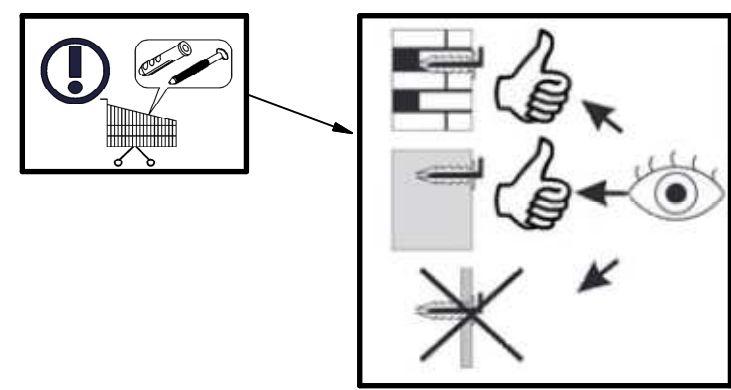
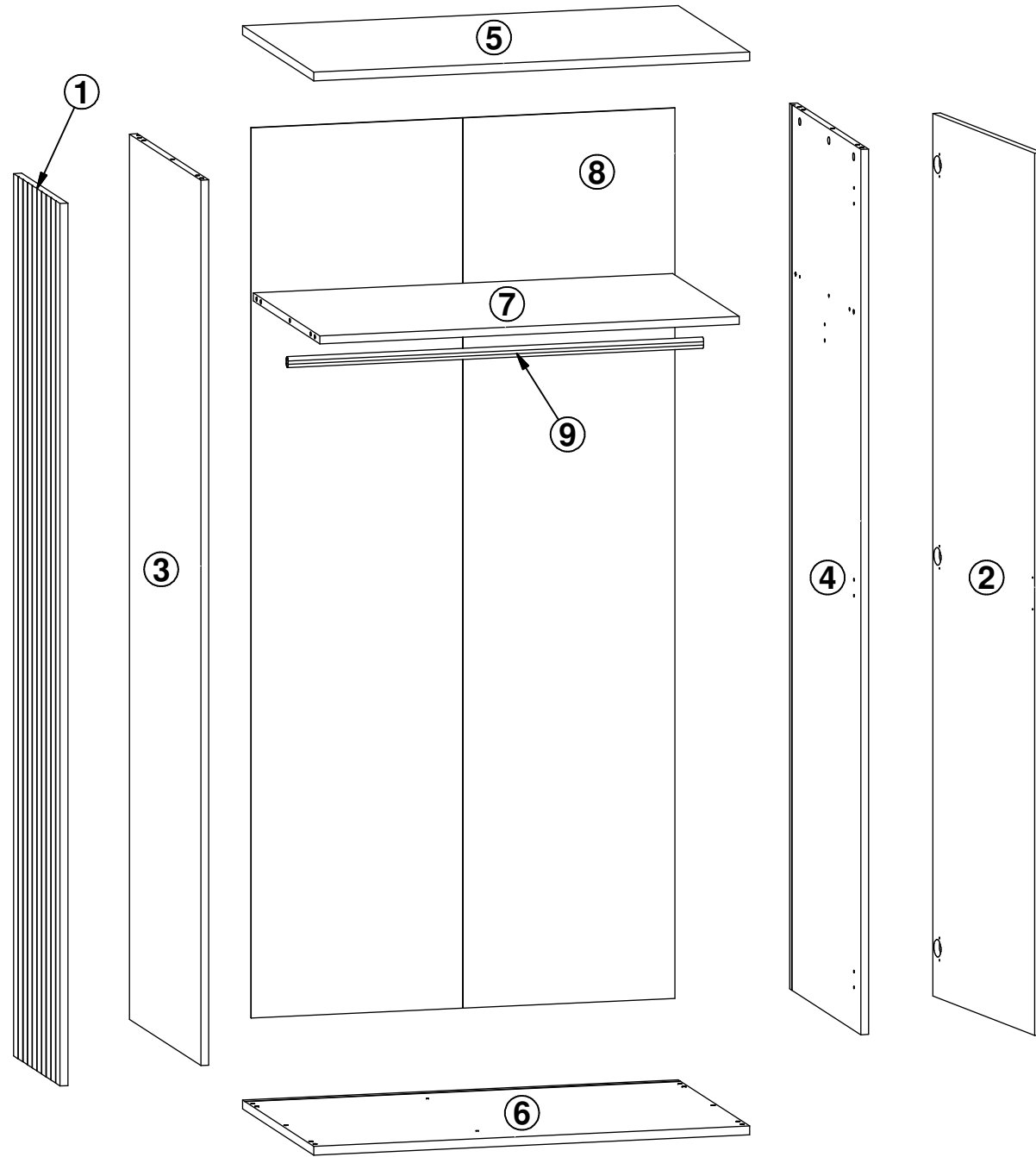

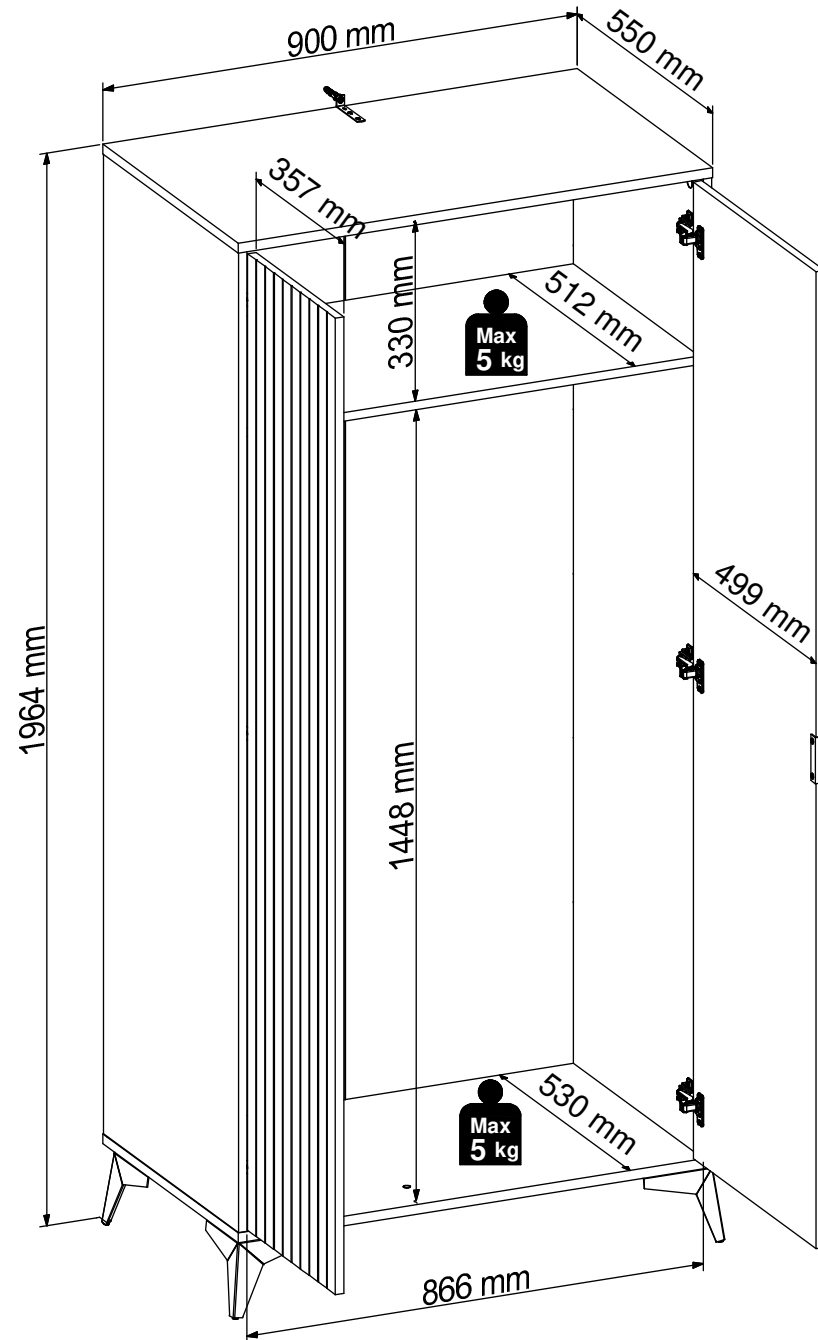

A

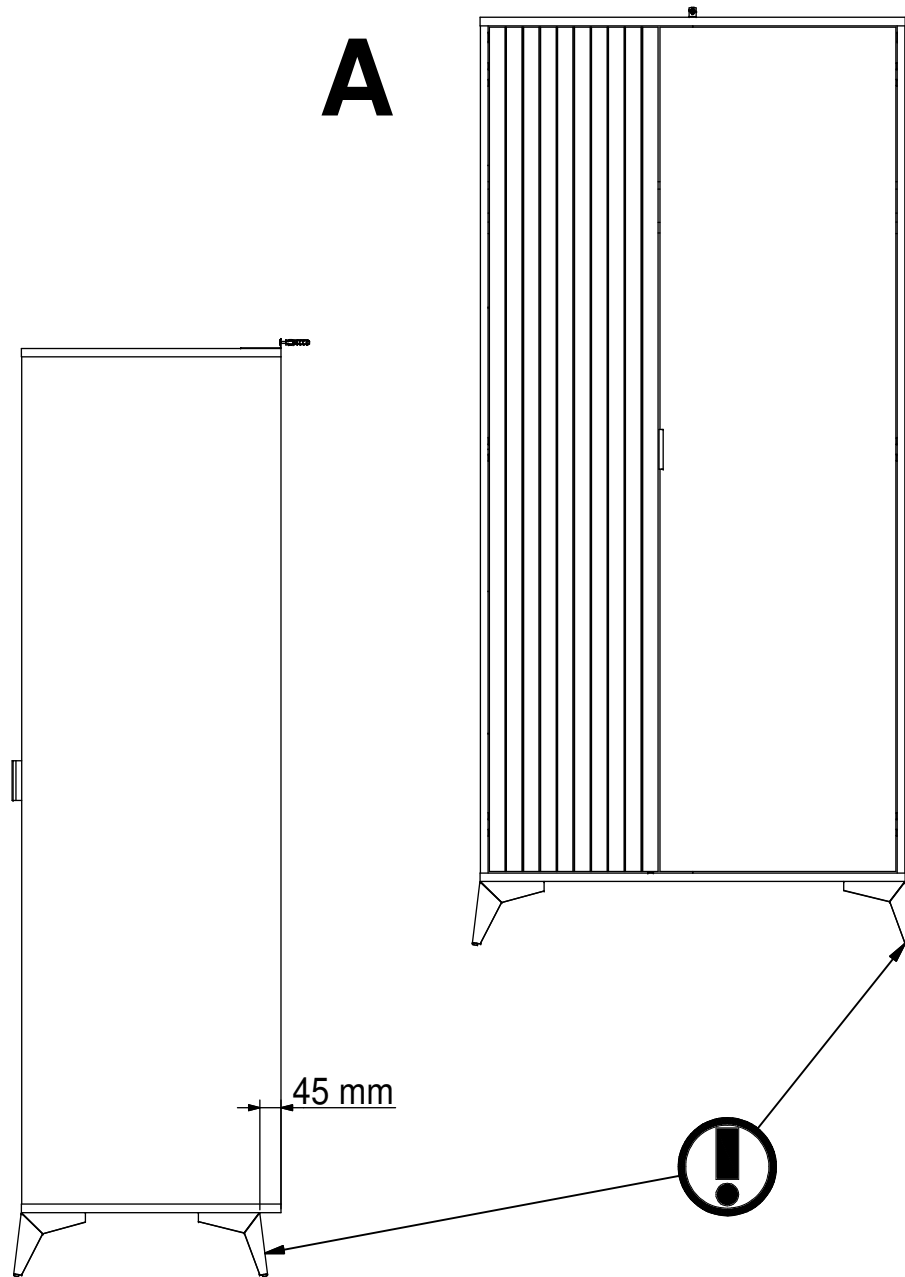

B

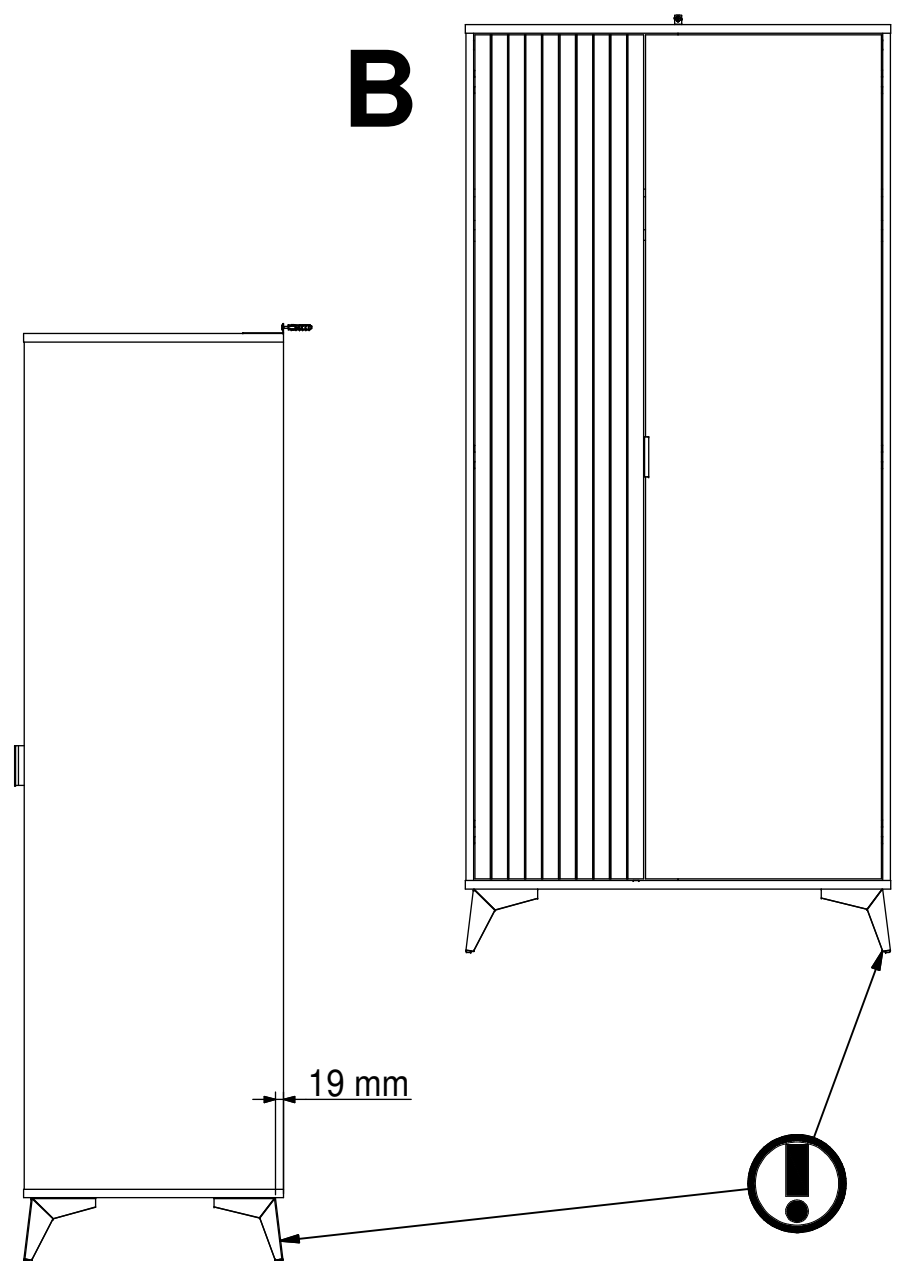

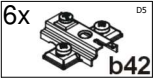
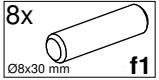
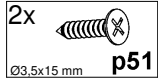
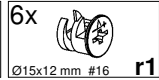
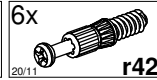
- 1 6x  b42
- 8x  f1
- 2x  n278
- 2x  p51
- 6x  r1
- 6x  r42

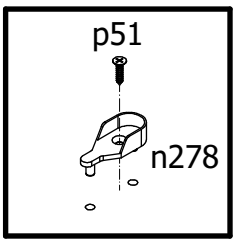
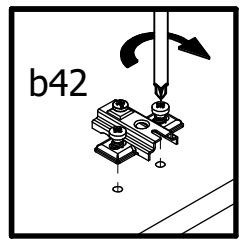
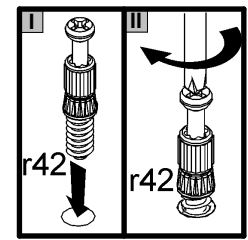
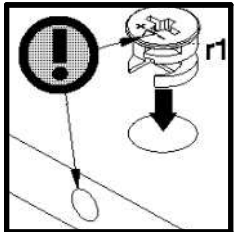
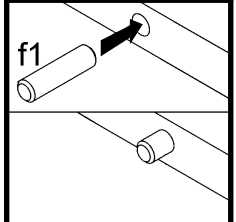
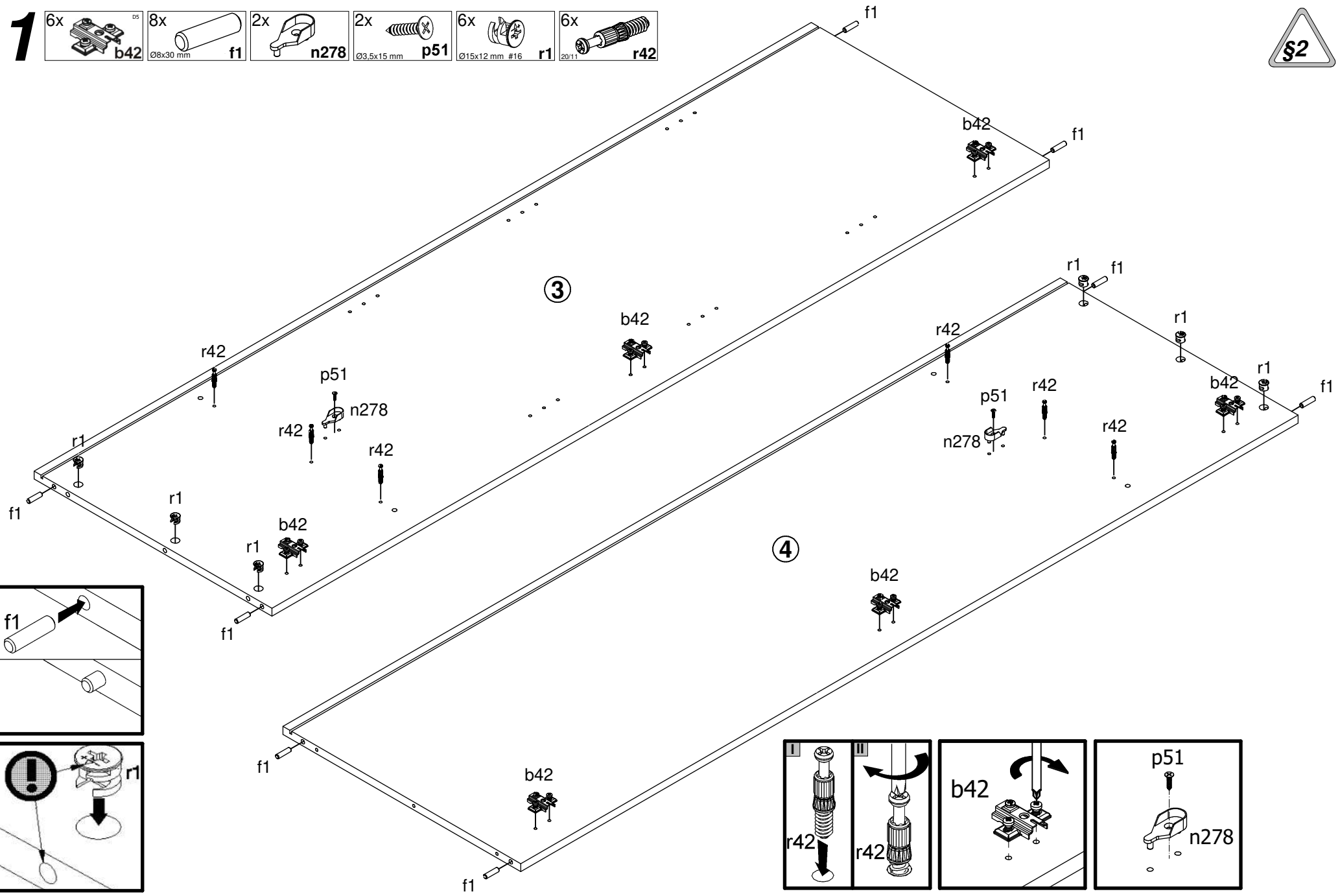

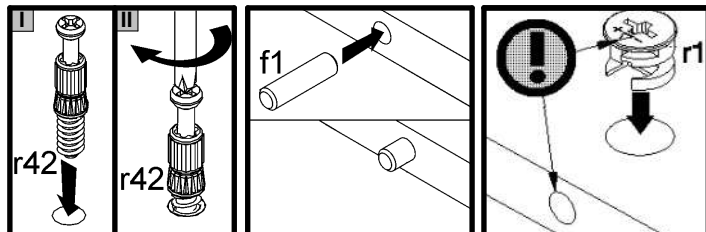
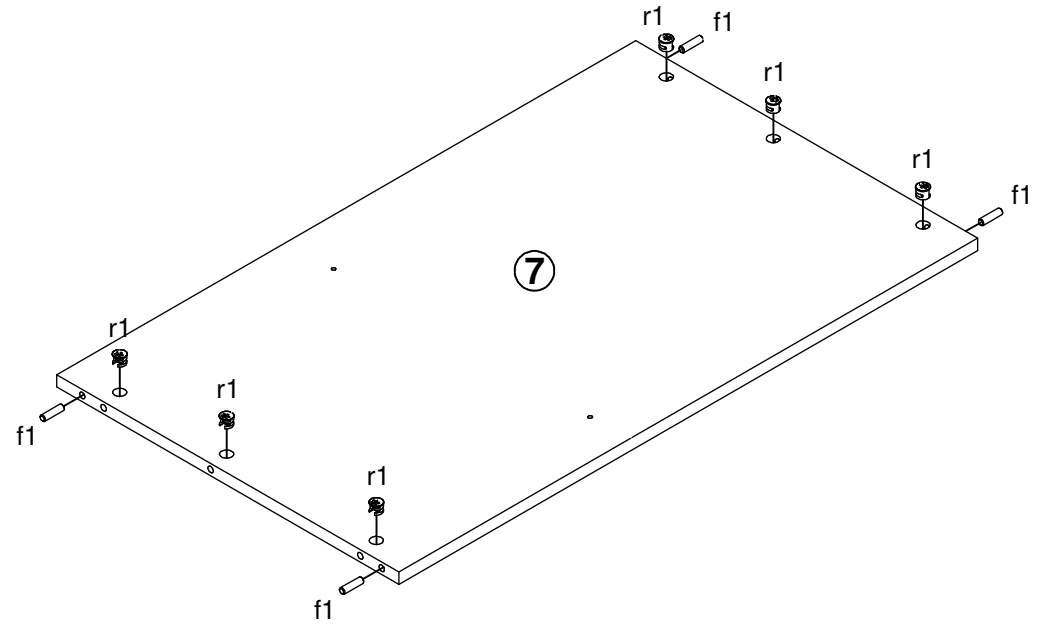
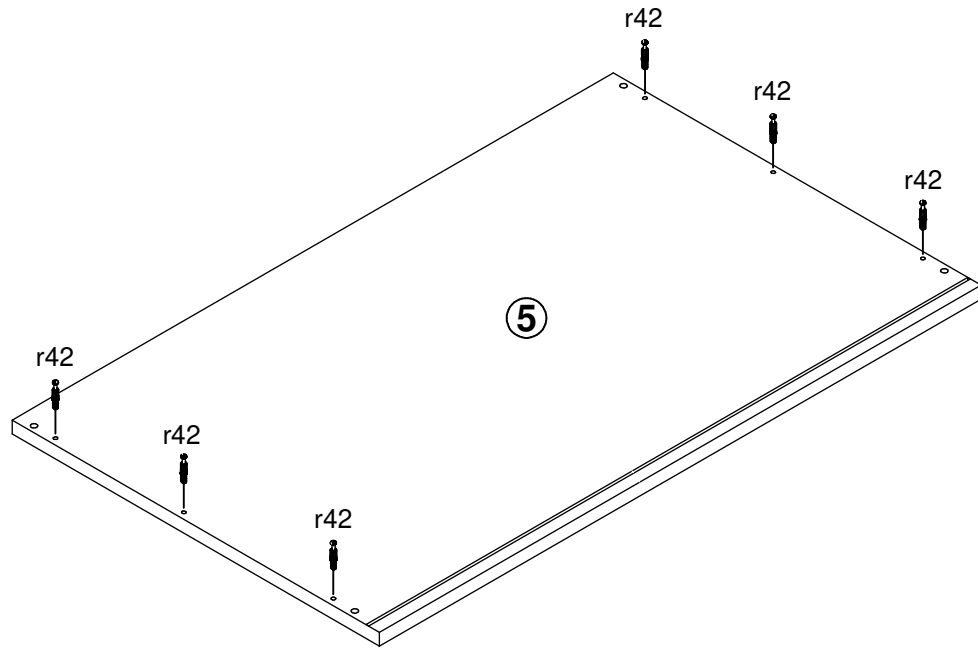
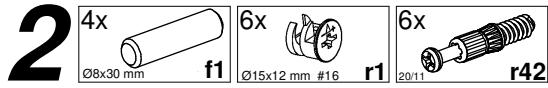

3

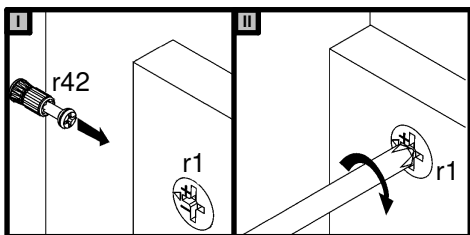
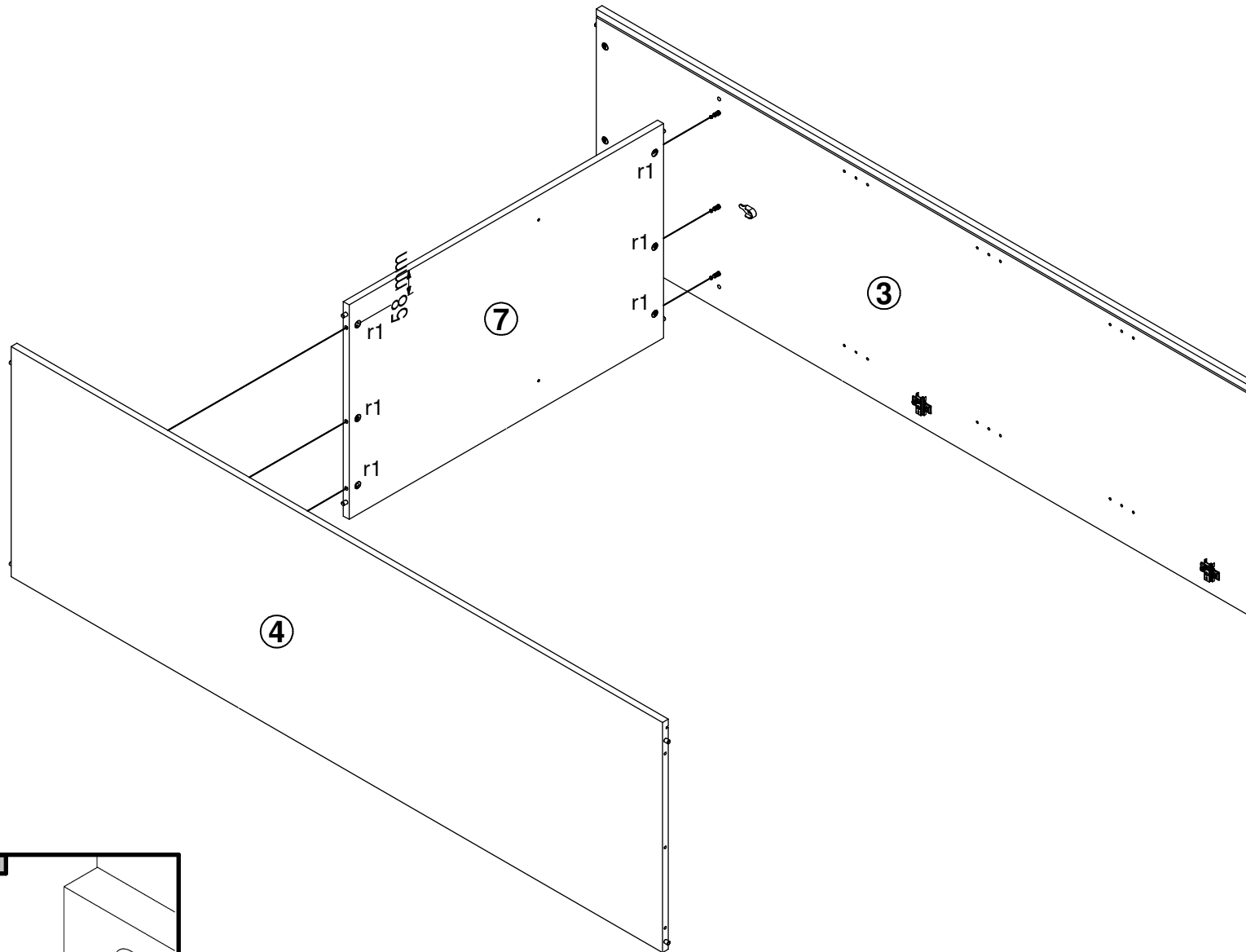

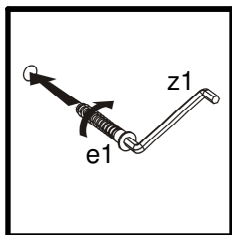
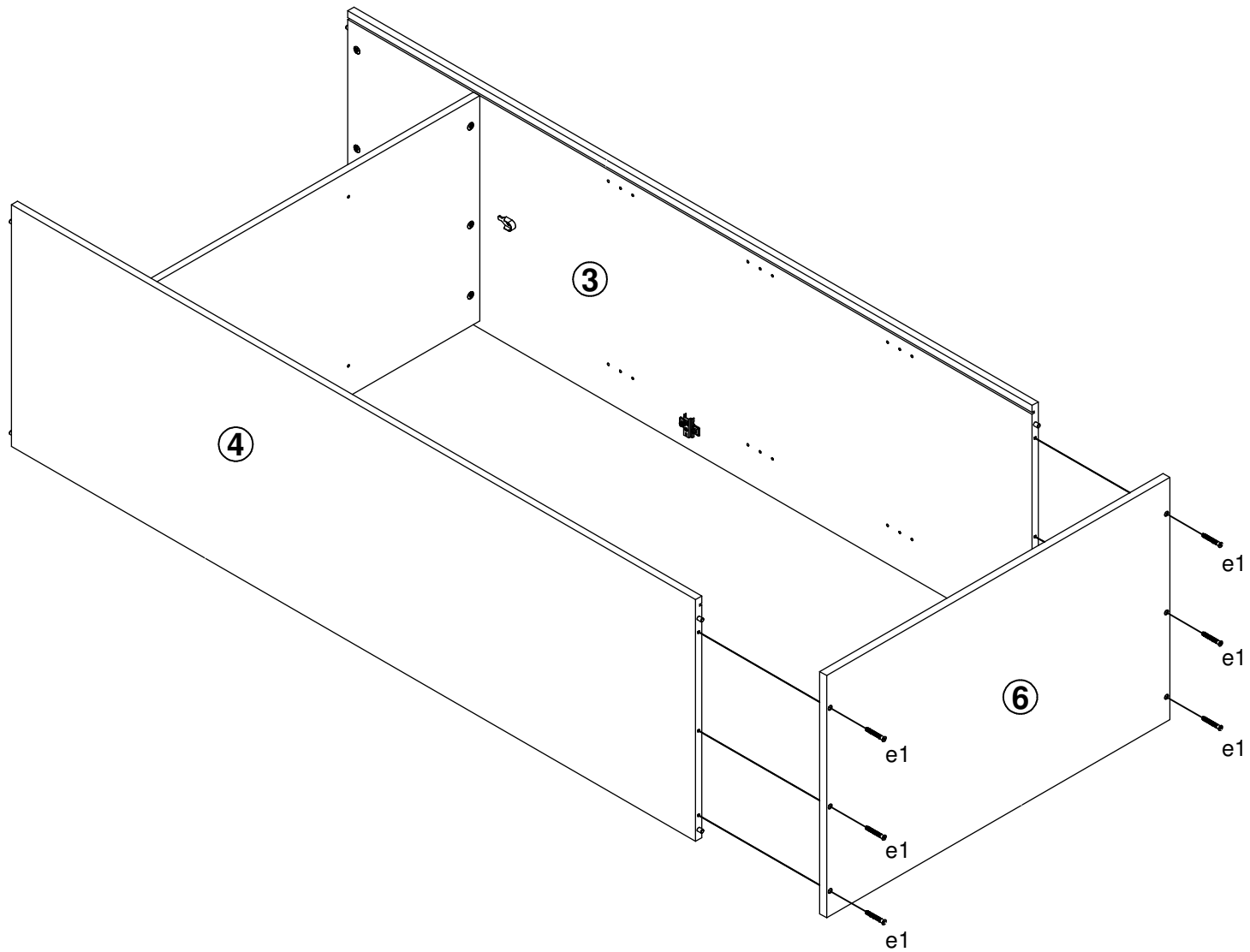
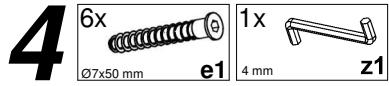



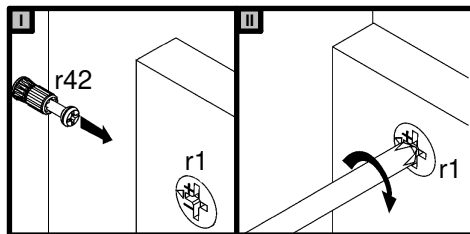
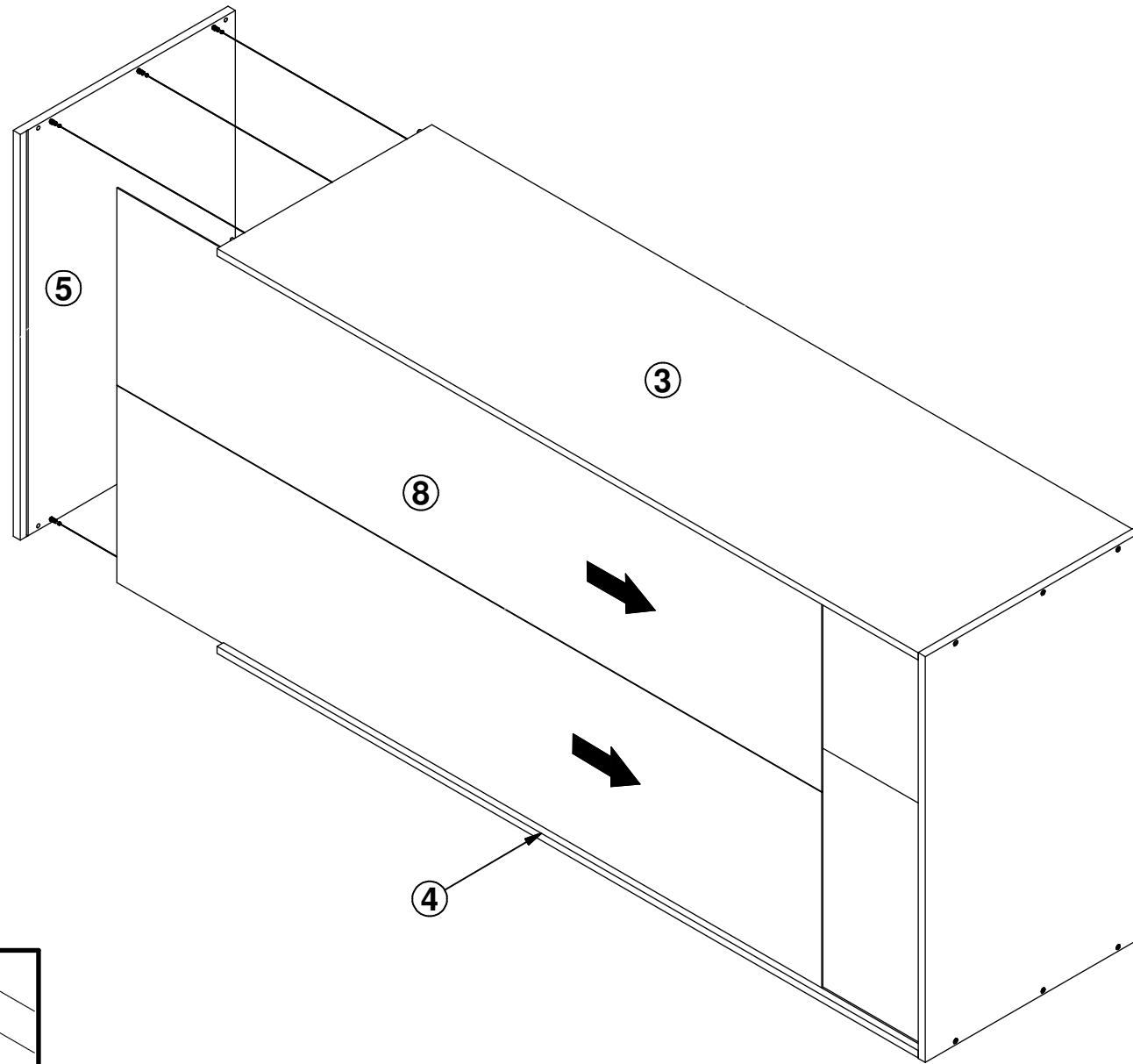

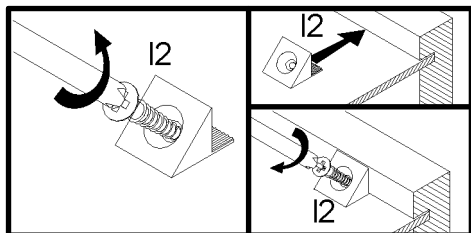
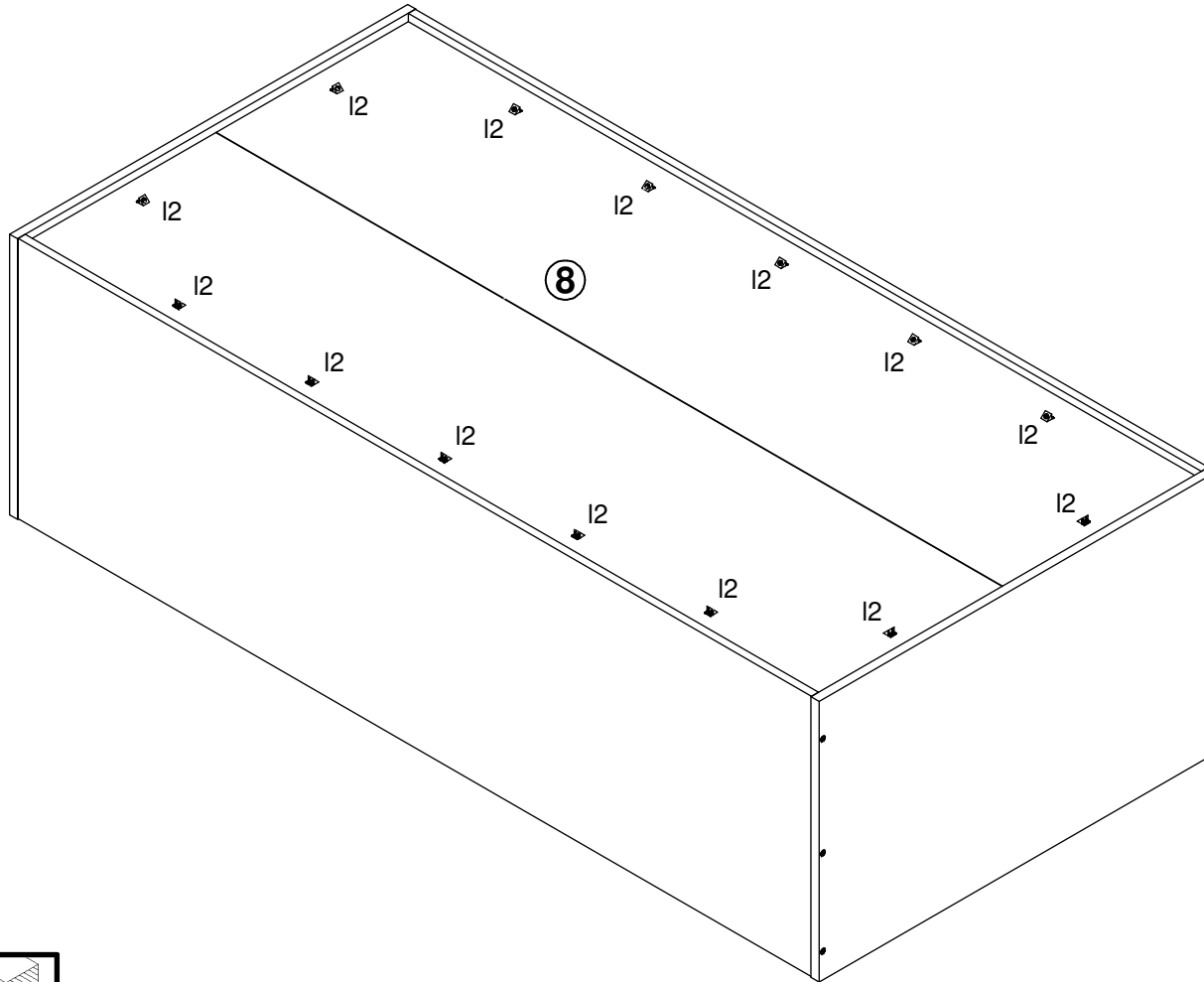
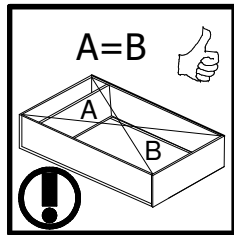
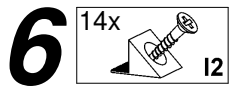
5

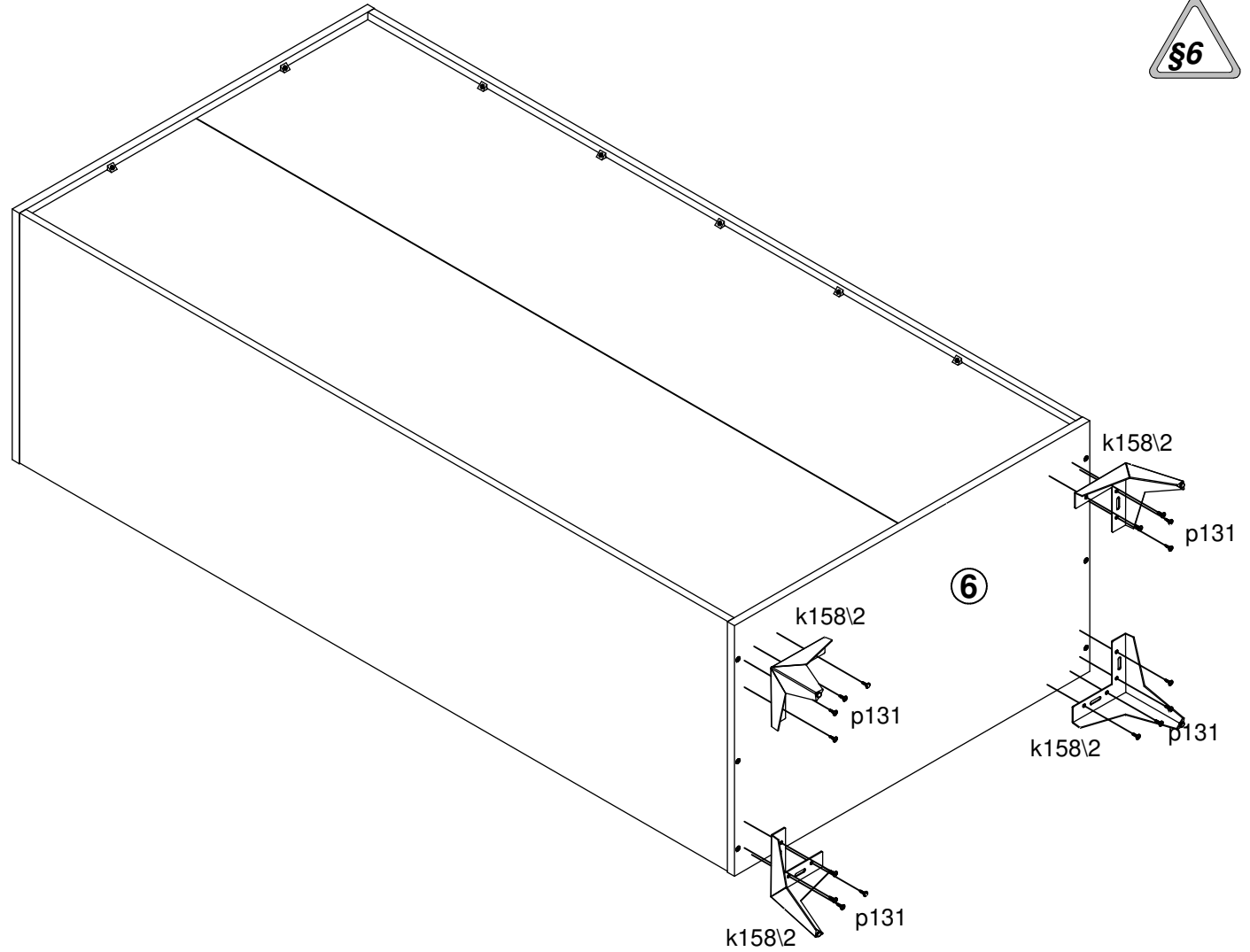
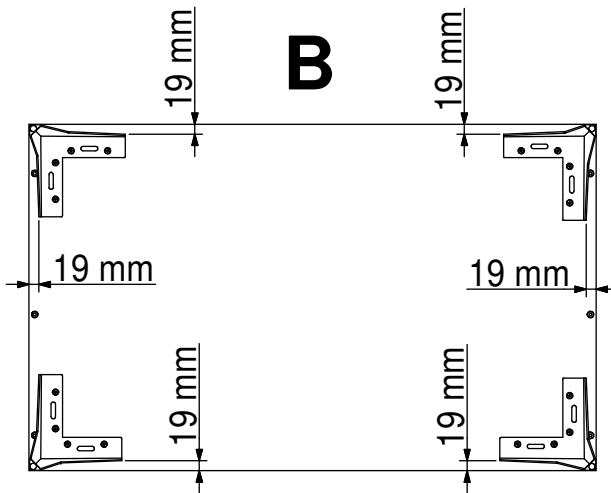
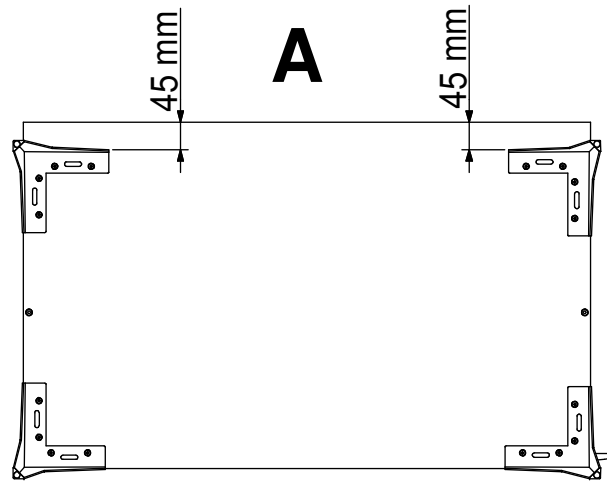
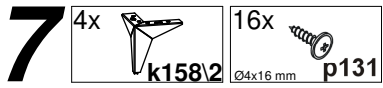





- 8 1x  n14/2
- 2x  p51
- 4x  s59
- 12x  s68

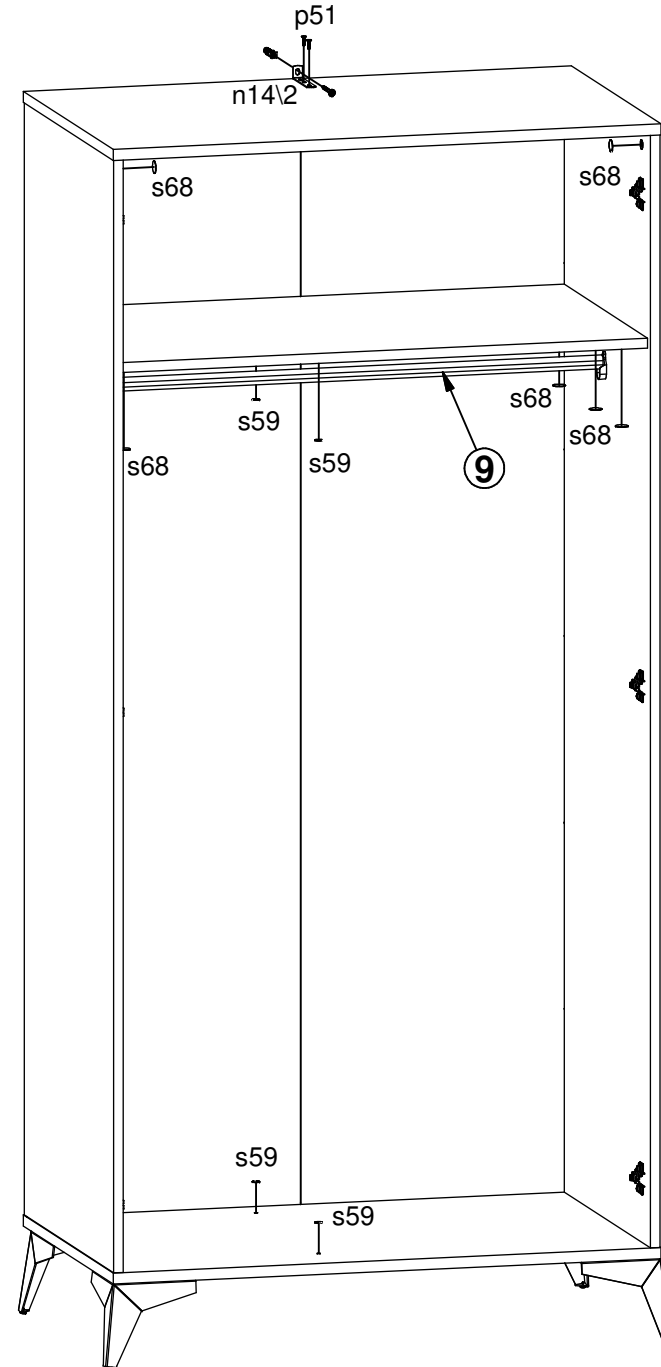
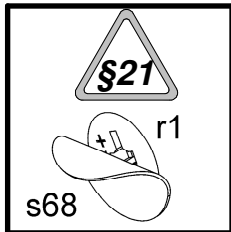
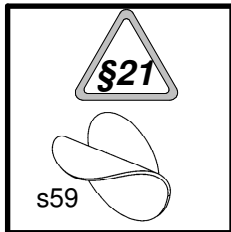
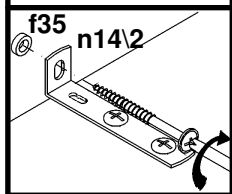
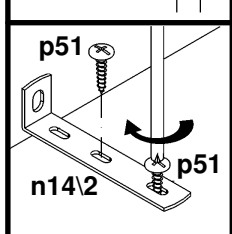
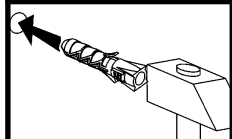
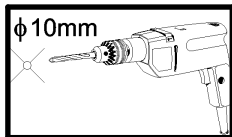

9 6x  a172 12x  p51
K18 Ø35 Ø3,5x15 mm

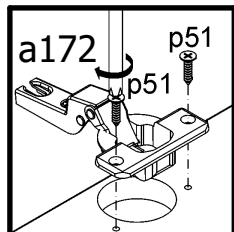
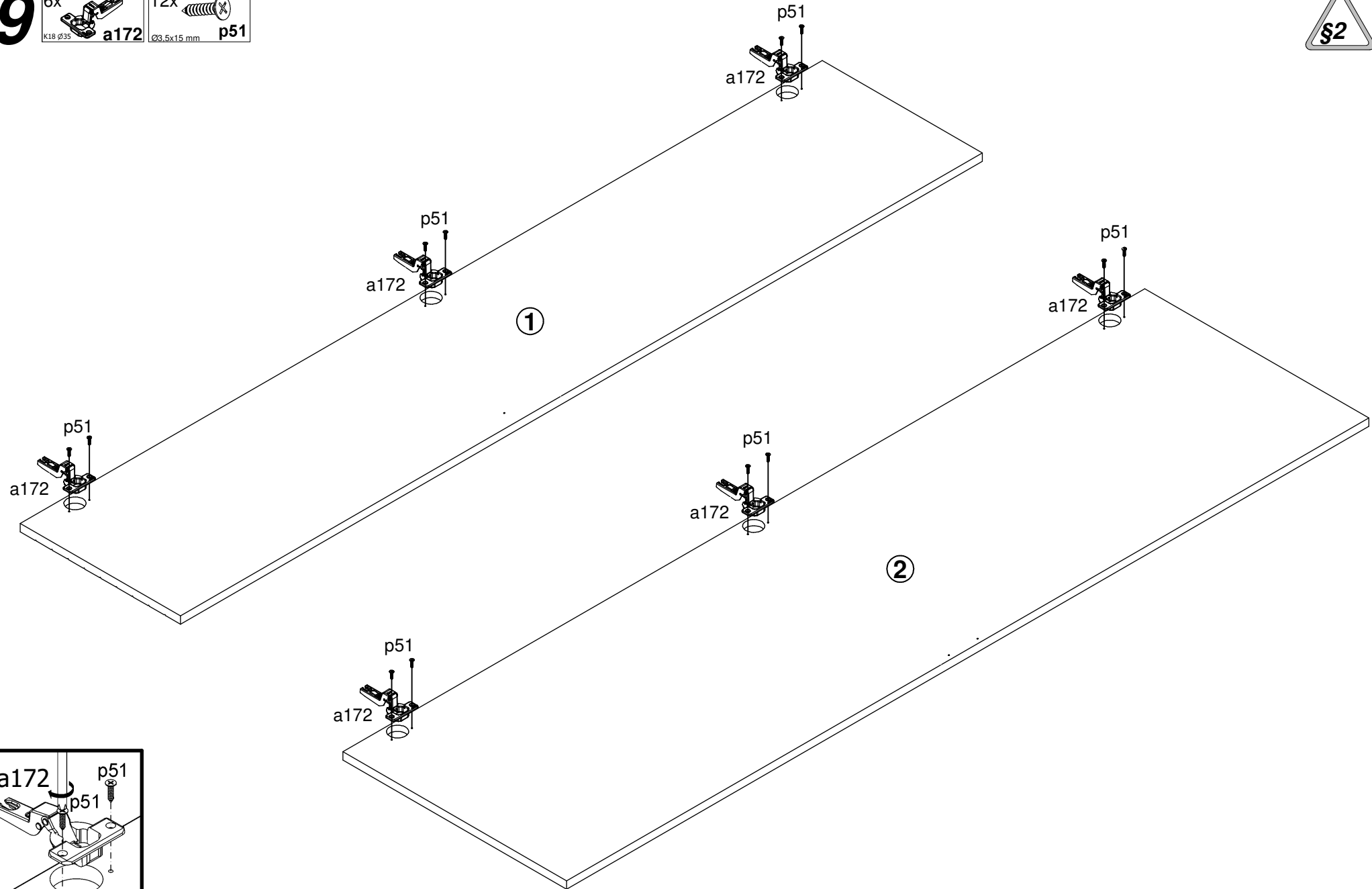

10

