

A

BERGEN

S359-RTV3S

A	B	C	D	A	B	C	D		
1	S359-0012	455	176	4/5	13	S359-5011	1537	80	3/5
2	S359-0013	455	176	4/5	14	S359-5012	1537	80	3/5
3	S359-0014	455	176	4/5	15	S359-5013	330	80	3/5
4	S359-1015	490	435	1/5	16	S359-5014	330	80	3/5
5	S359-1016	490	435	1/5	17	S359-9002	422	355	2/5
6	S359-1017	229	415	1/5	18	S359-9004	412	355	2/5
7	S359-1018	229	415	1/5	19	S359-9305	487	1512	2/5
8	S359-1019	229	415	1/5	20	ZQ2-1513	412	107	1/5
9	S359-1020	229	240	1/5	21	ZQ2-1514	402	107	1/5
10	S359-2005	1558	468	2/5	22	ZQ3-507	350	120	1/5
11	S359-3009	1504	435	2/5	23	ZQ3-508	350	120	1/5
12	S359-3010	1504	415	2/5					

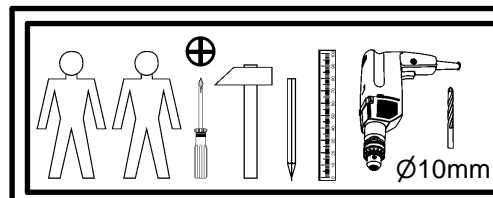
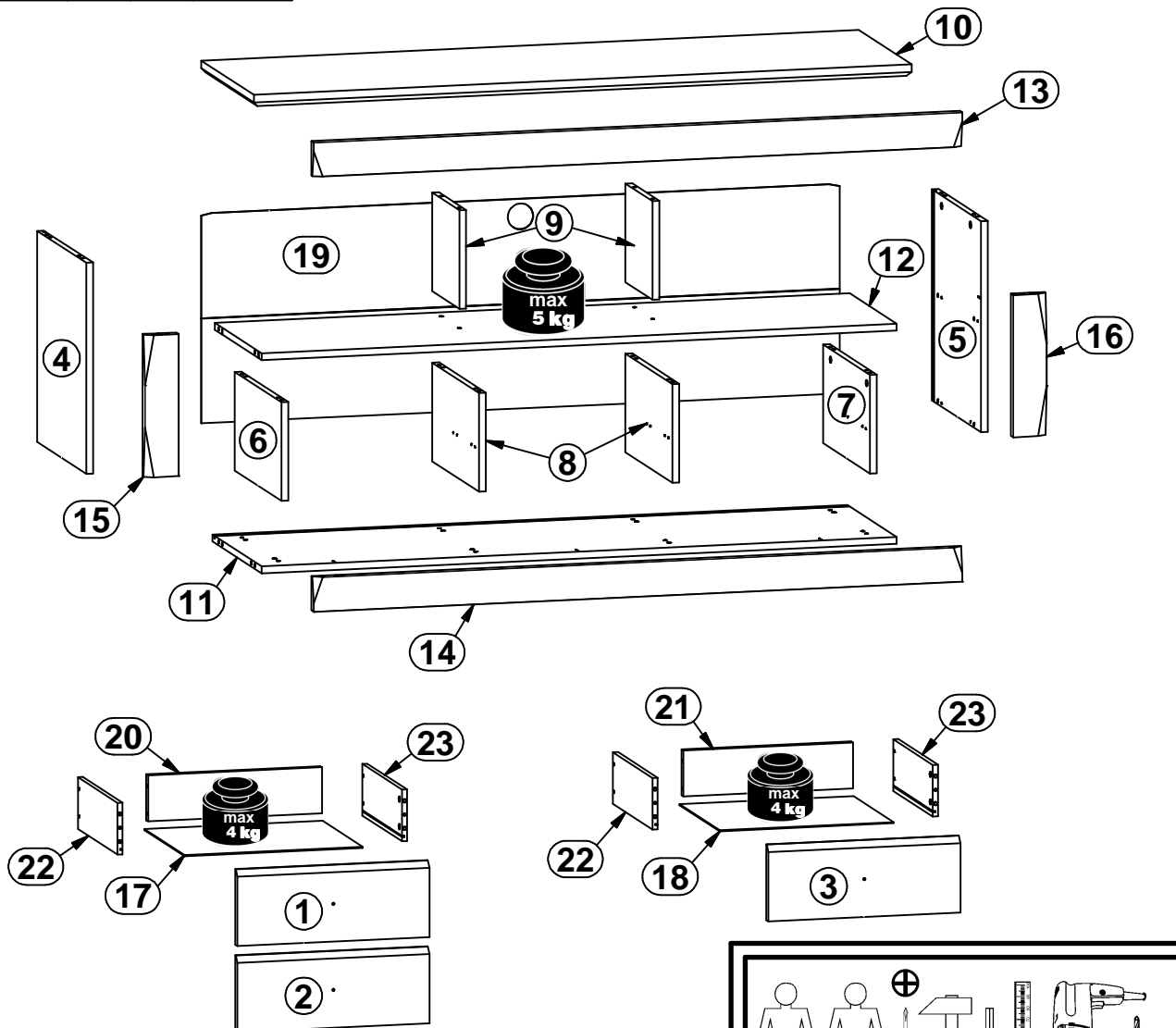
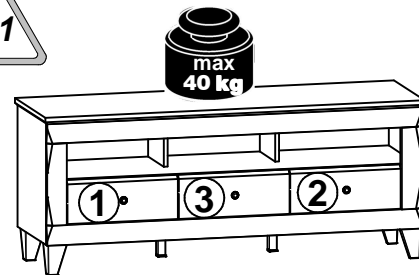

3x M4 c415	8x d37	8x Ø7x50 mm e1	2x Ø6,3x13 mm e2	24x Ø6x13 mm e3	12x Ø5x18 mm e58	44x Ø8x30 mm f1	12x Ø6,5x40 mm f25	6x Ø6x30 mm f9
3x M4x22 mm j30	4x k125	2x 42,5x42,5x4 mm k3813	2x 39x30x108 mm k3817	10x l1	14x l2	52x Ø3,5x16 mm p38	8x Ø15x12 mm #16 r1	12x Ø12x10,5 mm #12 r15
20x 20/11 r42	3x 350 mm W117\L	3x 350 mm W117\P						
							4x Ø20mm s68	1x 4 mm z1

1 

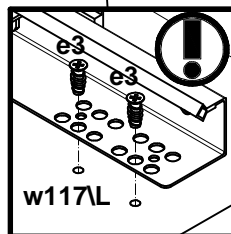
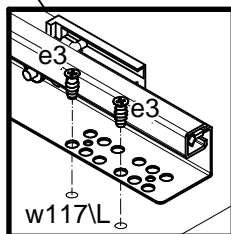
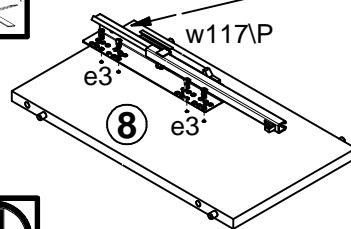
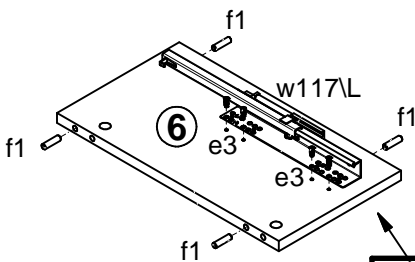
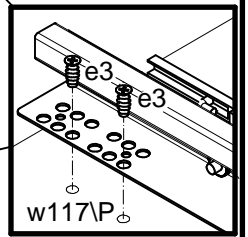
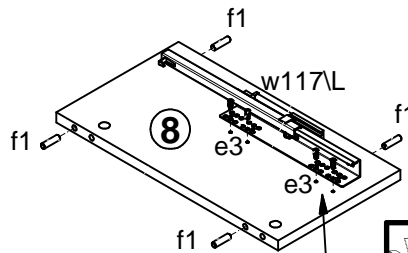
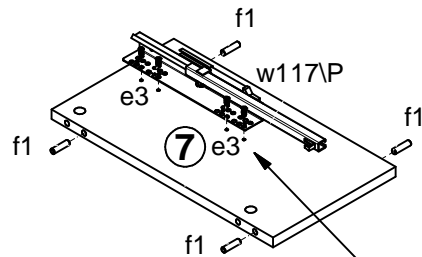
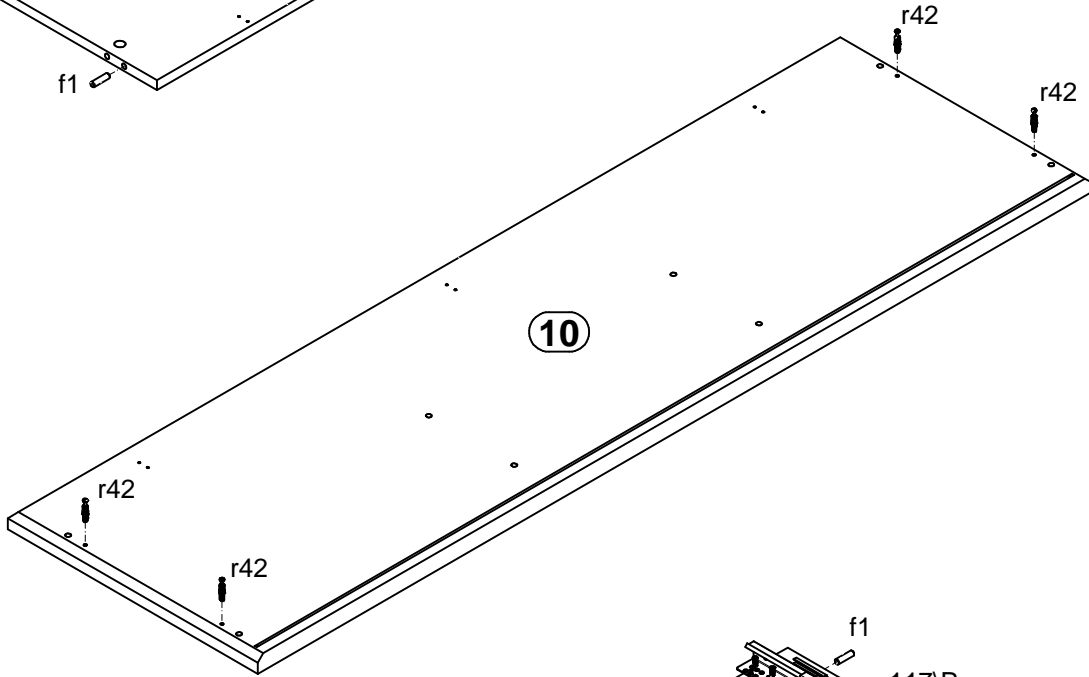
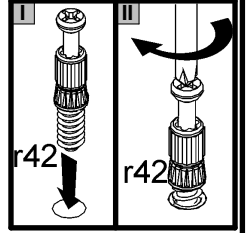
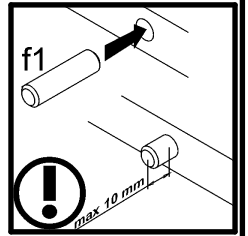
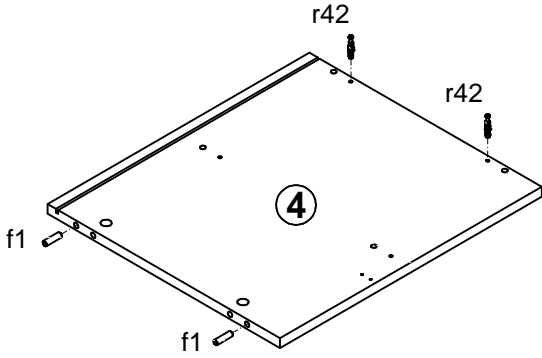
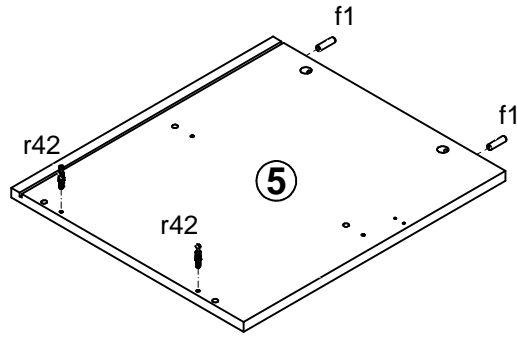

2

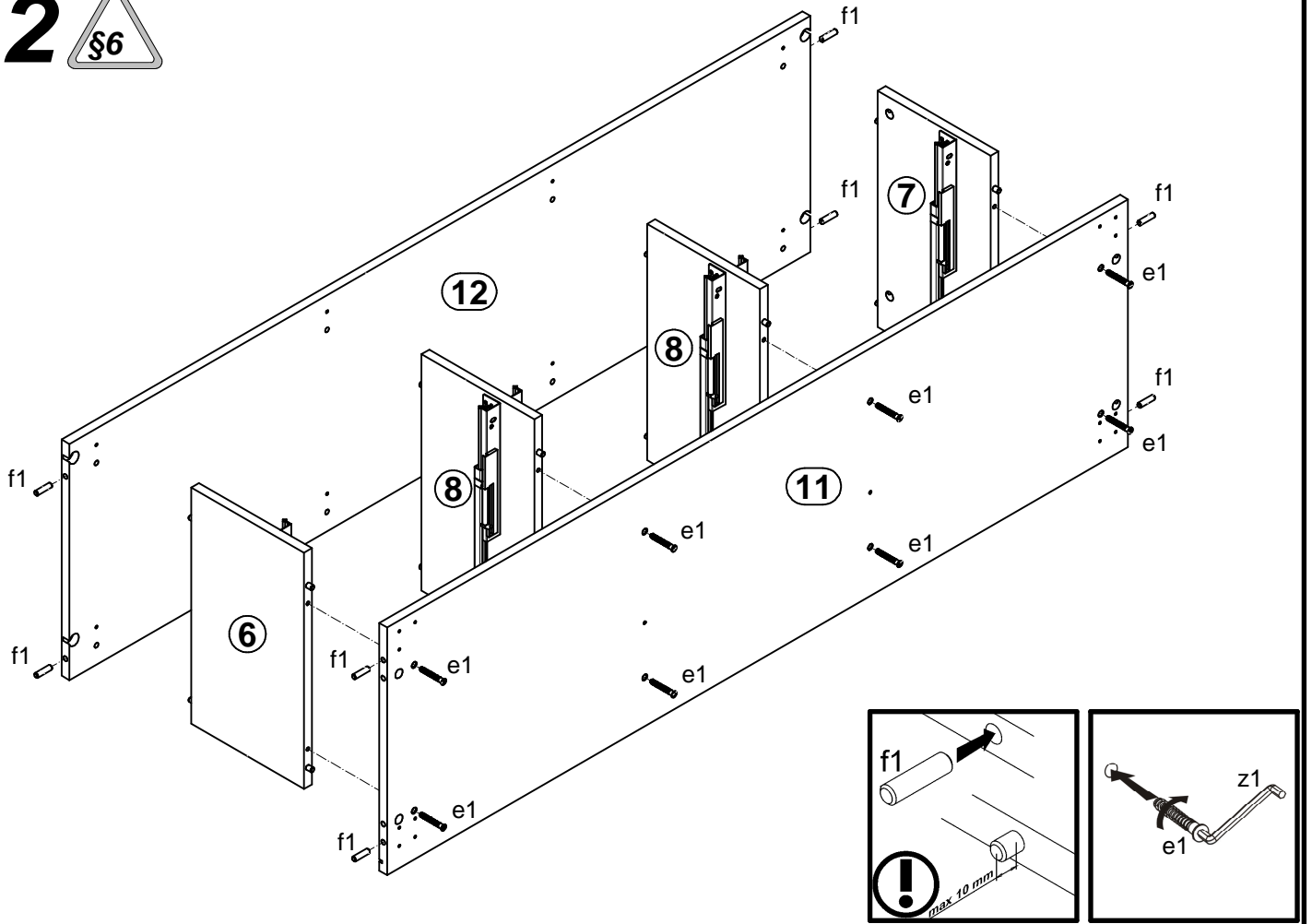

3

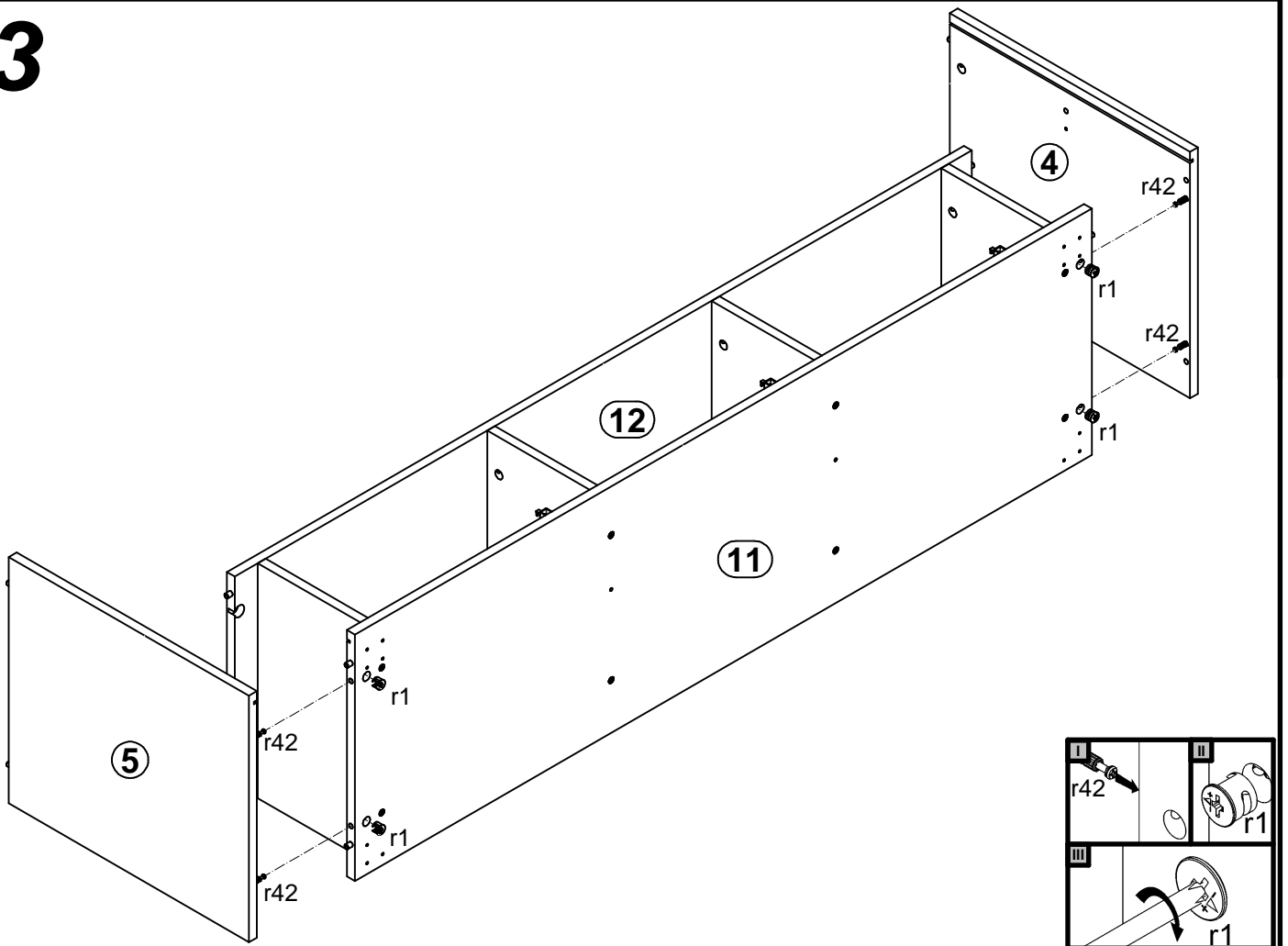

4

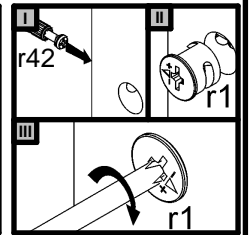
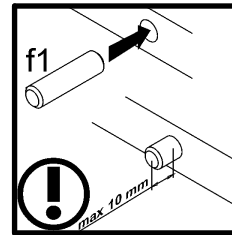
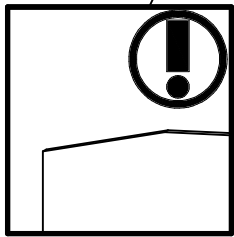
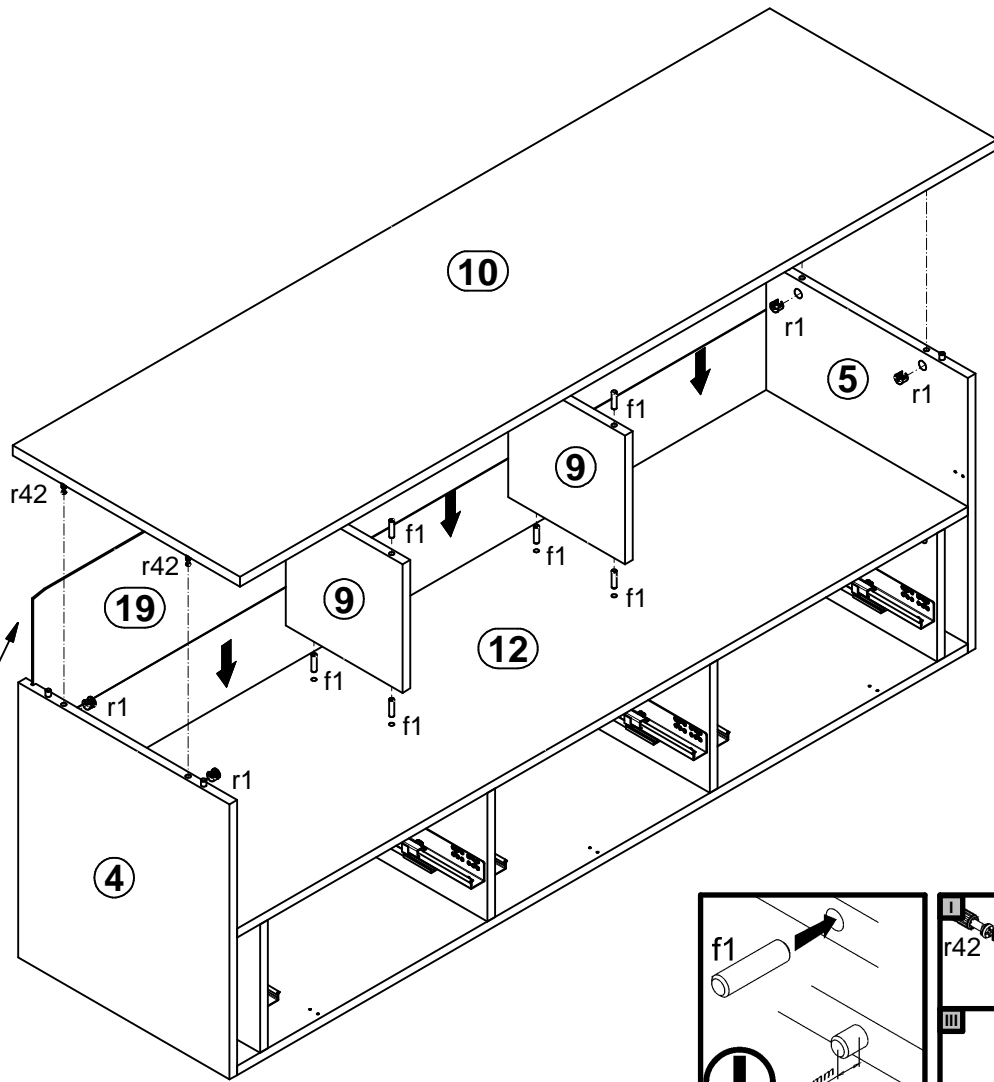

5

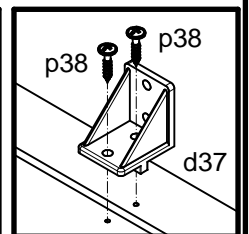
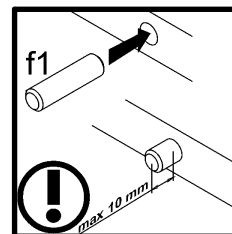
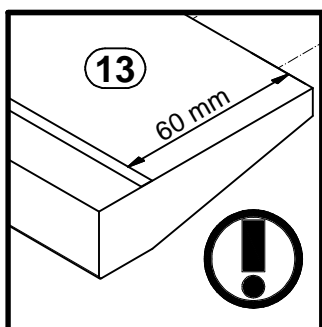
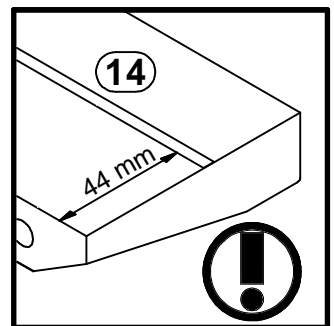
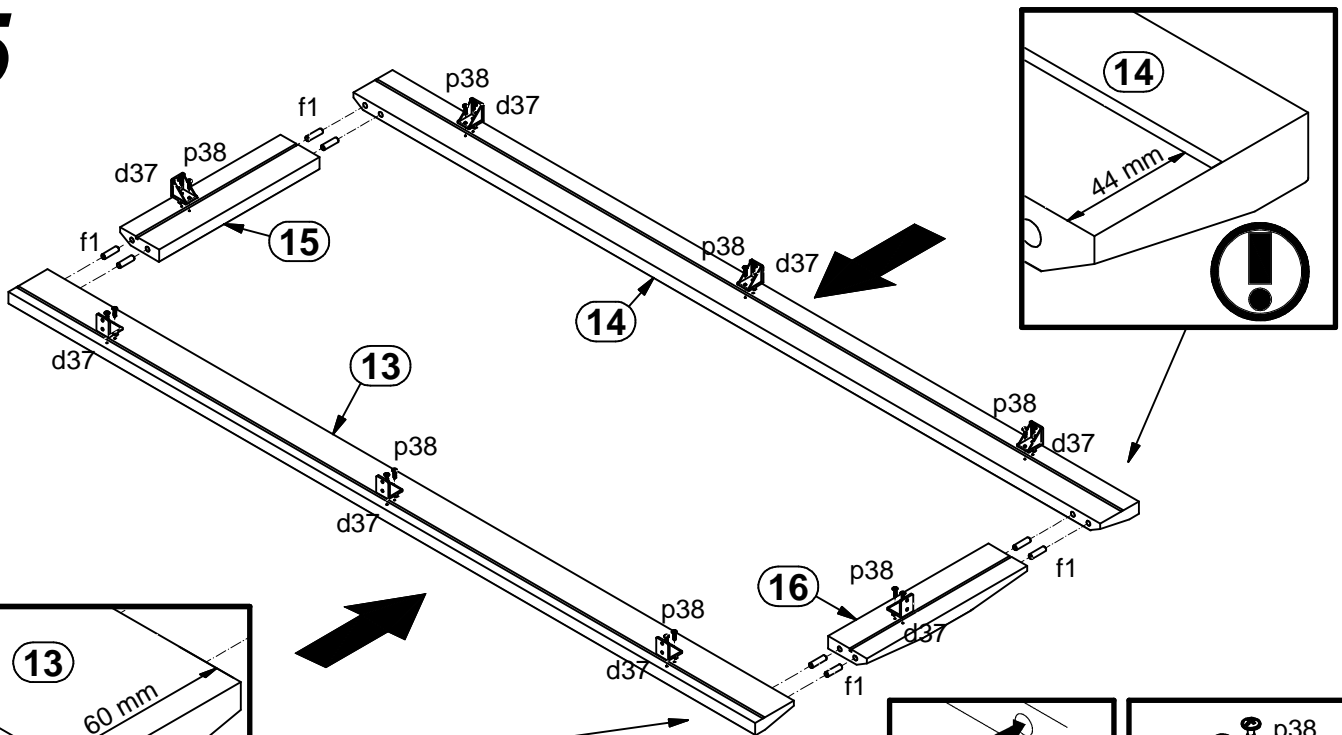

6

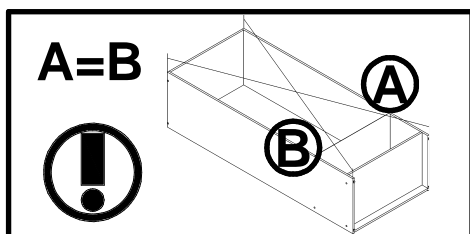
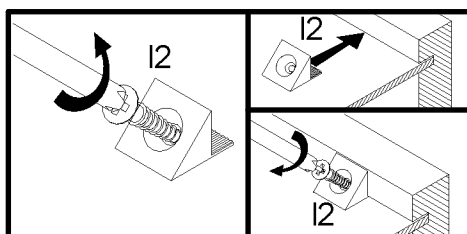
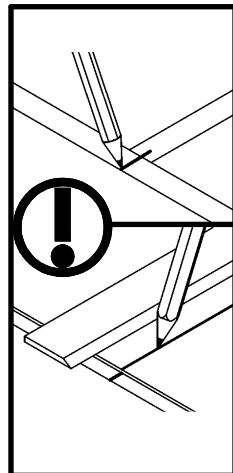
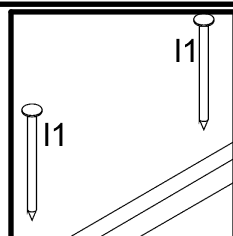
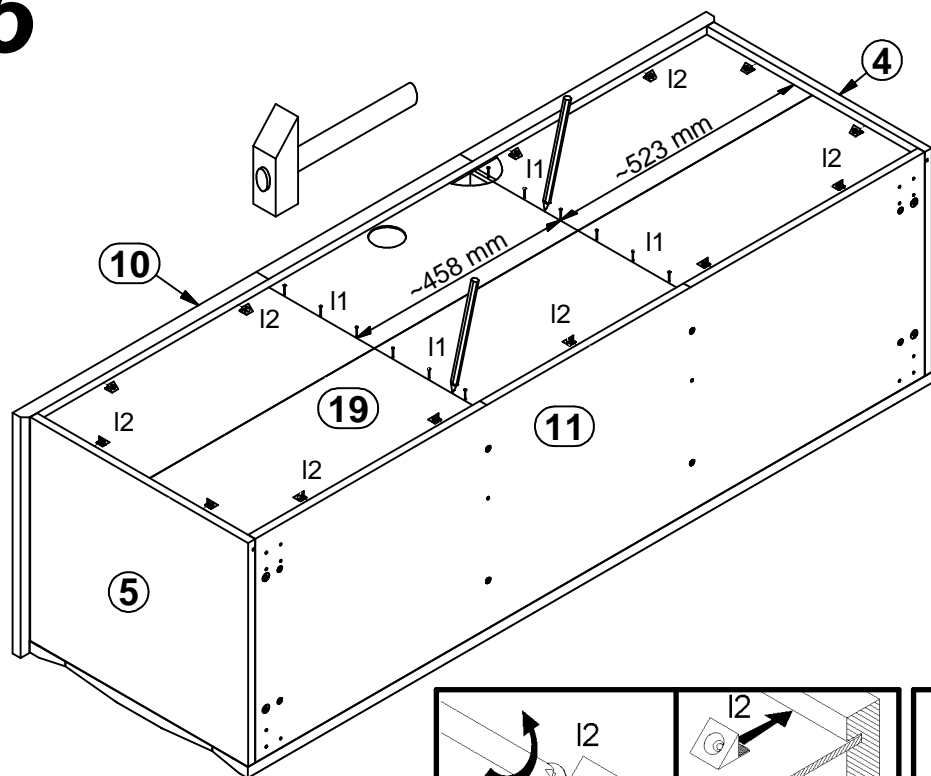

7

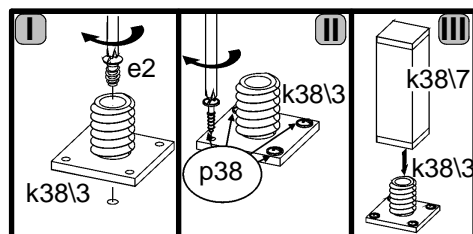
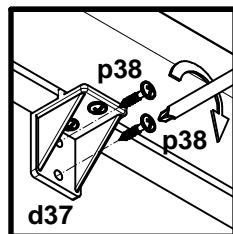
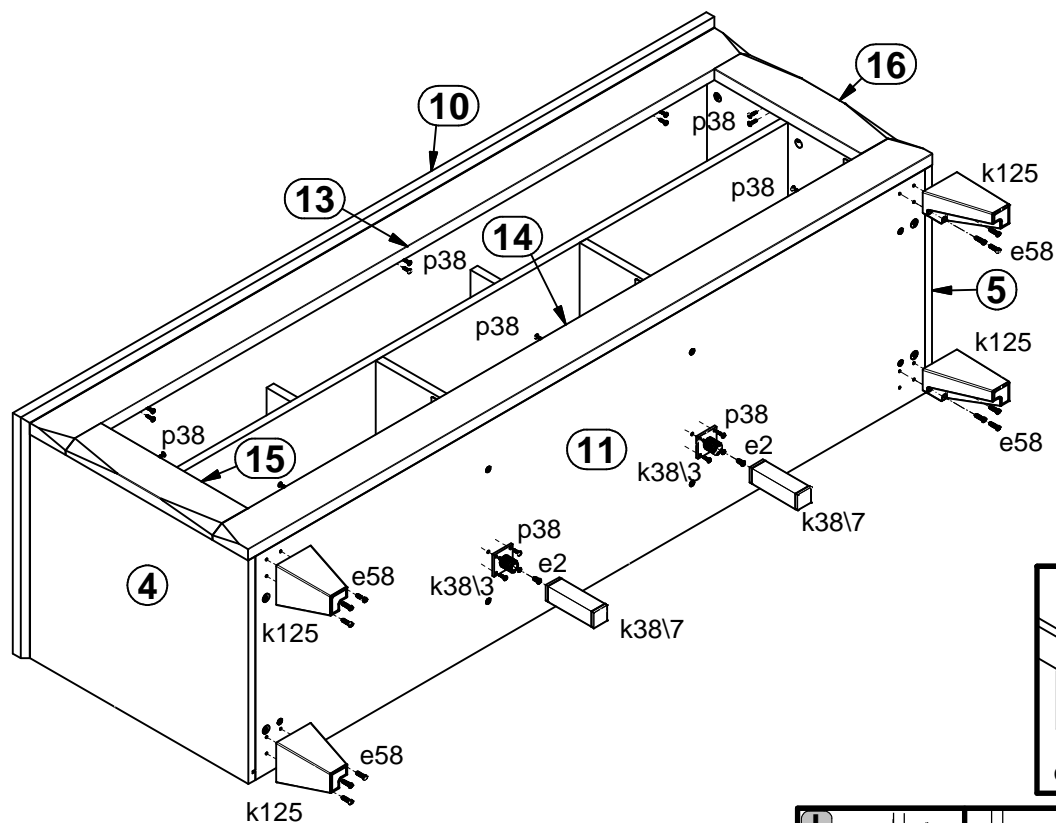

8

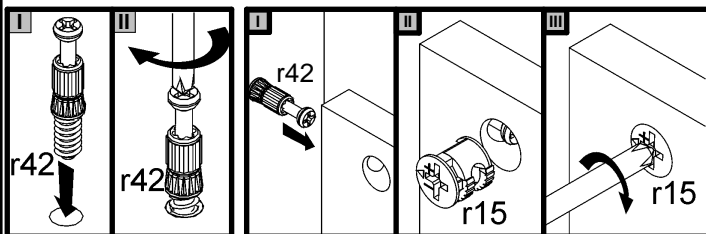
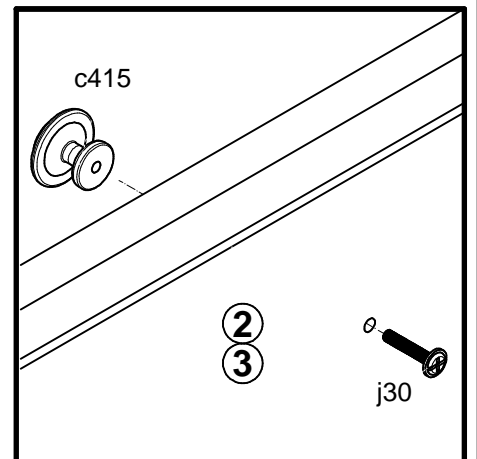
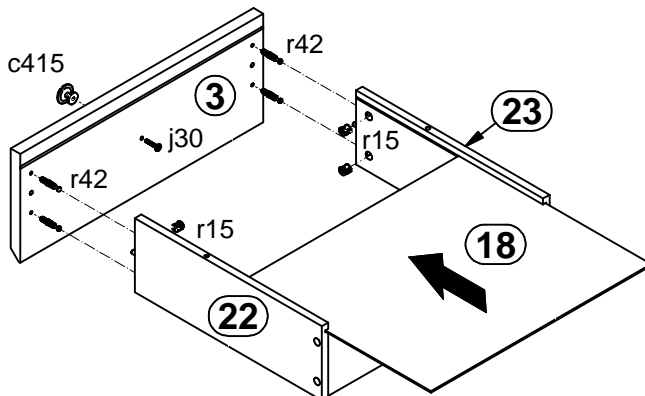
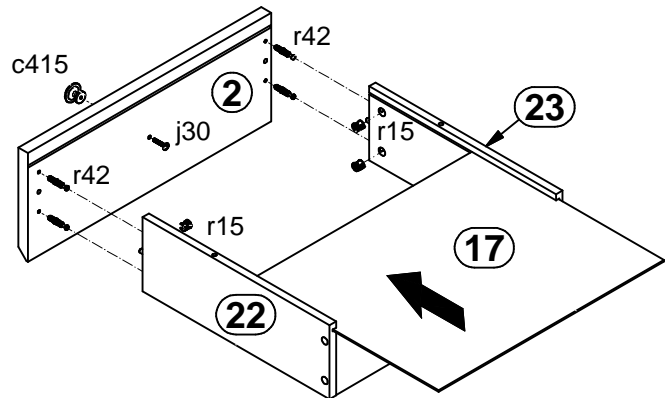
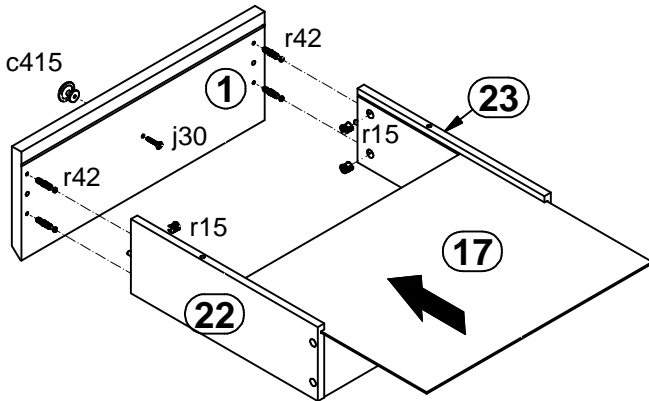
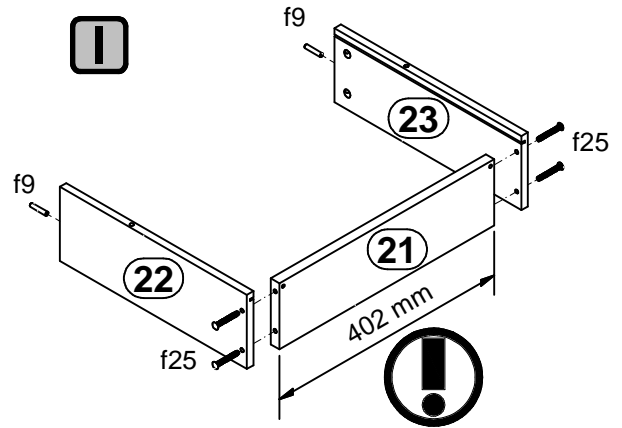
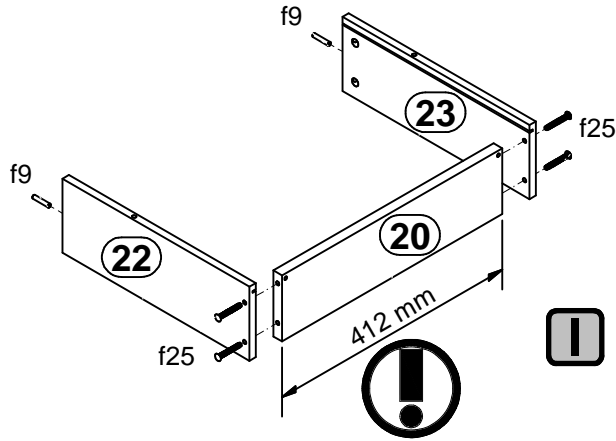
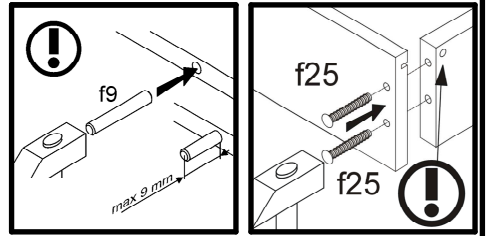

9

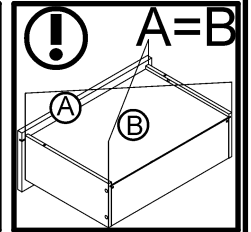
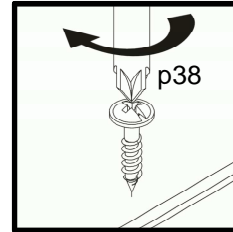
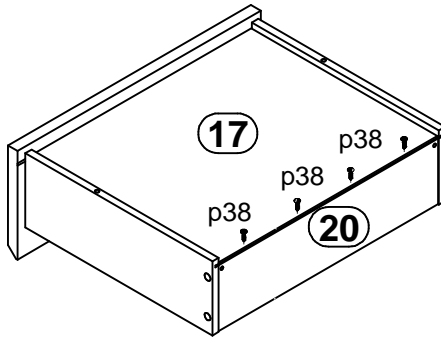
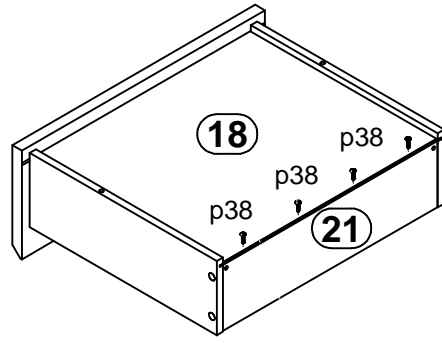
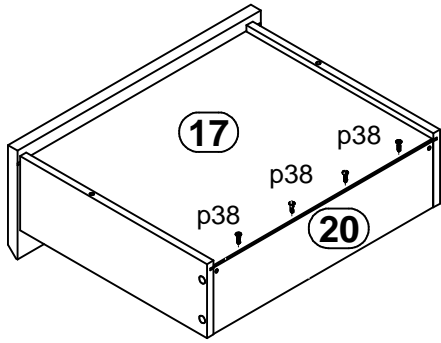

10

