

**A****NAMEK****S412-POL/2/6**

A	B	C	D
1	S412-3018	600	192
2	S412-4011	601	192

**1**

# 2

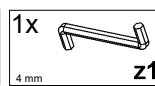
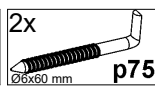
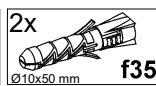
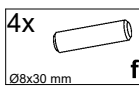
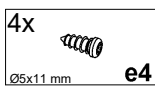
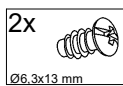
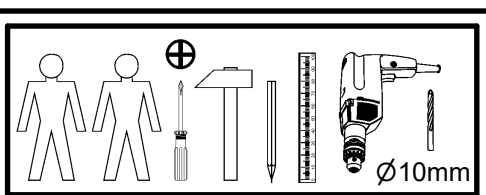
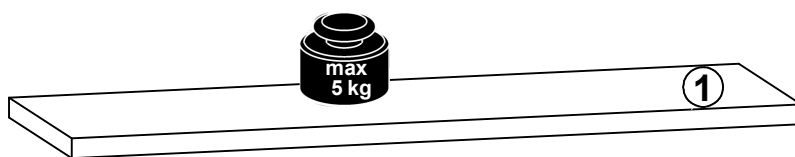
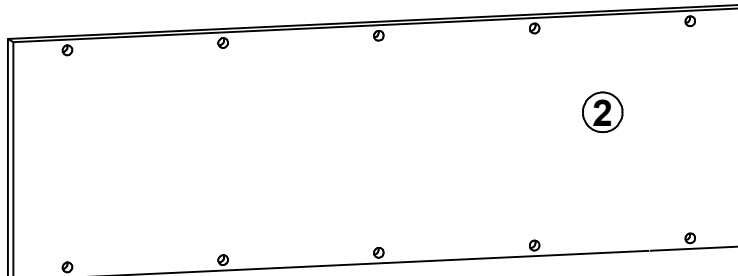
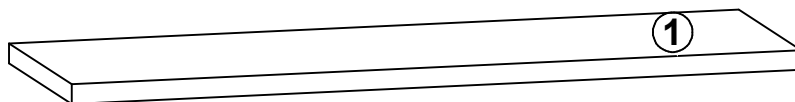
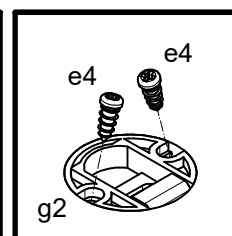
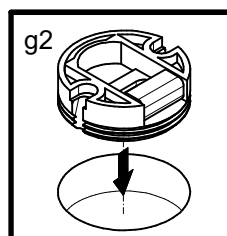
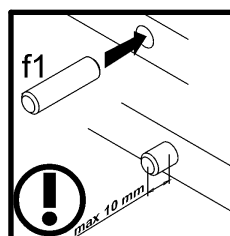
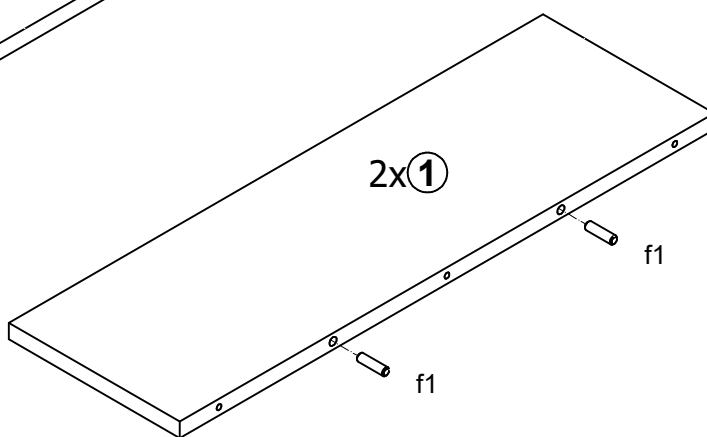
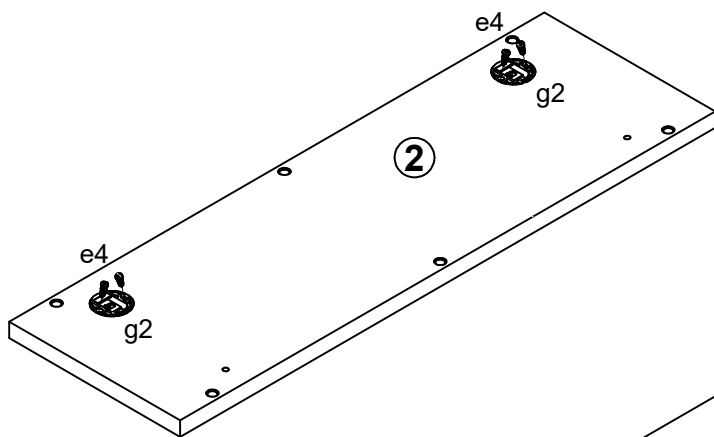
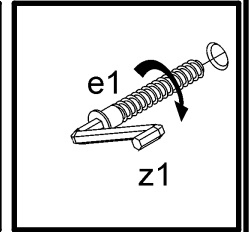
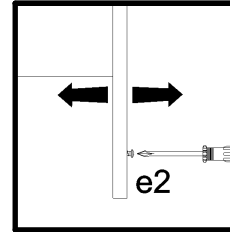
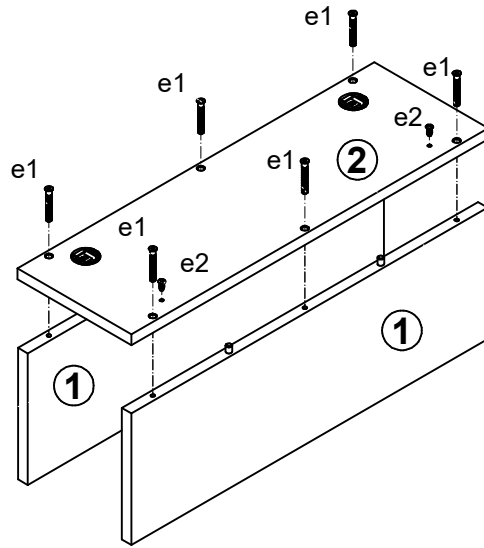

# 3



φ10 mm

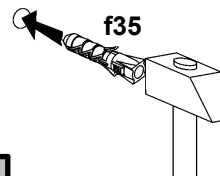
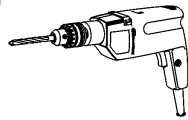

f35



p75

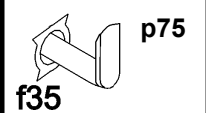

f35

p75

