

| A | B | C (mm) | | | D | A | B | C (mm) | | | D | A | B | C (mm) | | | D |
|---|-----------|--------|-----|----|-----|----|-----------|--------|-----|----|-----|----|-----------|--------|-----|-----|-----|
| 1 | S605-0009 | 495 | 304 | 16 | 1/3 | 8 | S605-1009 | 802 | 420 | 16 | 3/3 | 15 | S605-3008 | 518 | 318 | 16 | 3/3 |
| 2 | S605-0010 | 505 | 304 | 16 | 1/3 | 9 | S605-1010 | 802 | 420 | 16 | 3/3 | 16 | S605-4003 | 1517 | 60 | 16 | 2/3 |
| 3 | S605-0011 | 495 | 304 | 16 | 1/3 | 10 | S605-1011 | 802 | 362 | 16 | 3/3 | 17 | S605-4004 | 338 | 60 | 16 | 2/3 |
| 4 | S605-0025 | 505 | 254 | 16 | 1/3 | 11 | S605-1012 | 802 | 362 | 16 | 3/3 | 18 | S605-4005 | 802 | 60 | 28 | 3/3 |
| 5 | S605-0026 | 505 | 254 | 16 | 1/3 | 12 | S605-2001 | 1597 | 420 | 16 | 2/3 | 19 | S605-4006 | 1508 | 60 | 28 | 2/3 |
| 6 | S605-0027 | 505 | 254 | 16 | 1/3 | 13 | S605-2002 | 1597 | 420 | 16 | 2/3 | 20 | S605-9302 | 812 | 531 | 2,5 | 2/3 |
| 7 | S605-0028 | 505 | 254 | 16 | 1/3 | 14 | S605-3007 | 493 | 318 | 16 | 3/3 | 21 | S605-9303 | 812 | 513 | 2,5 | 2/3 |

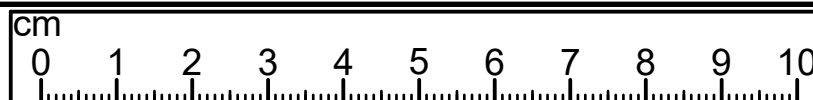

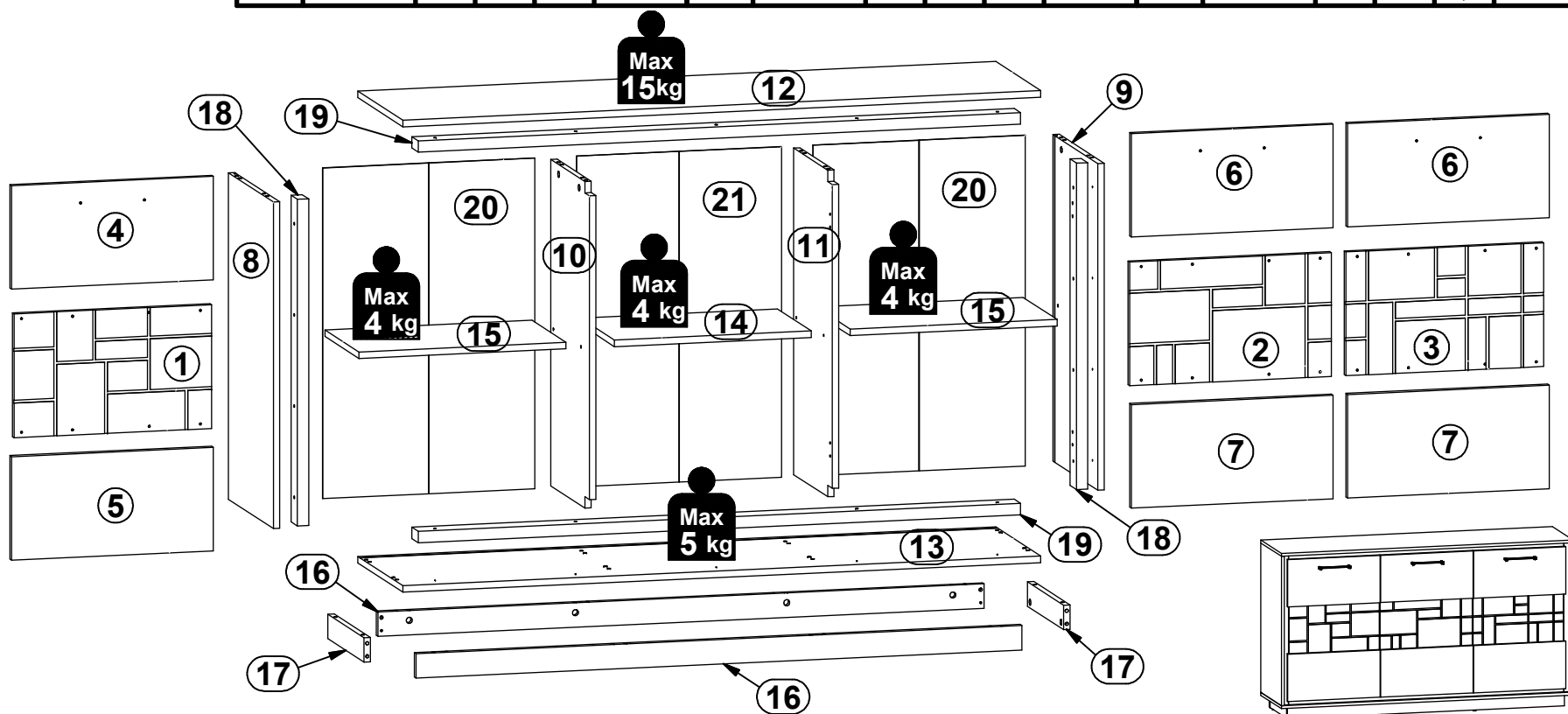

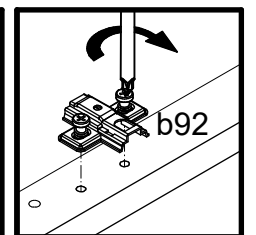
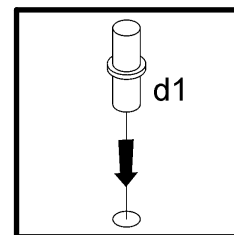
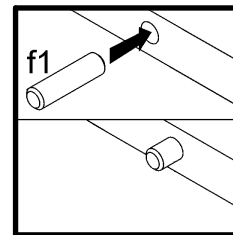
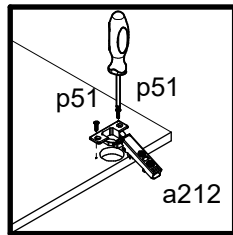
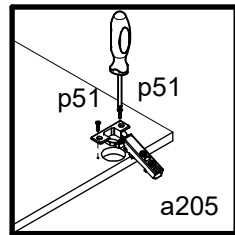
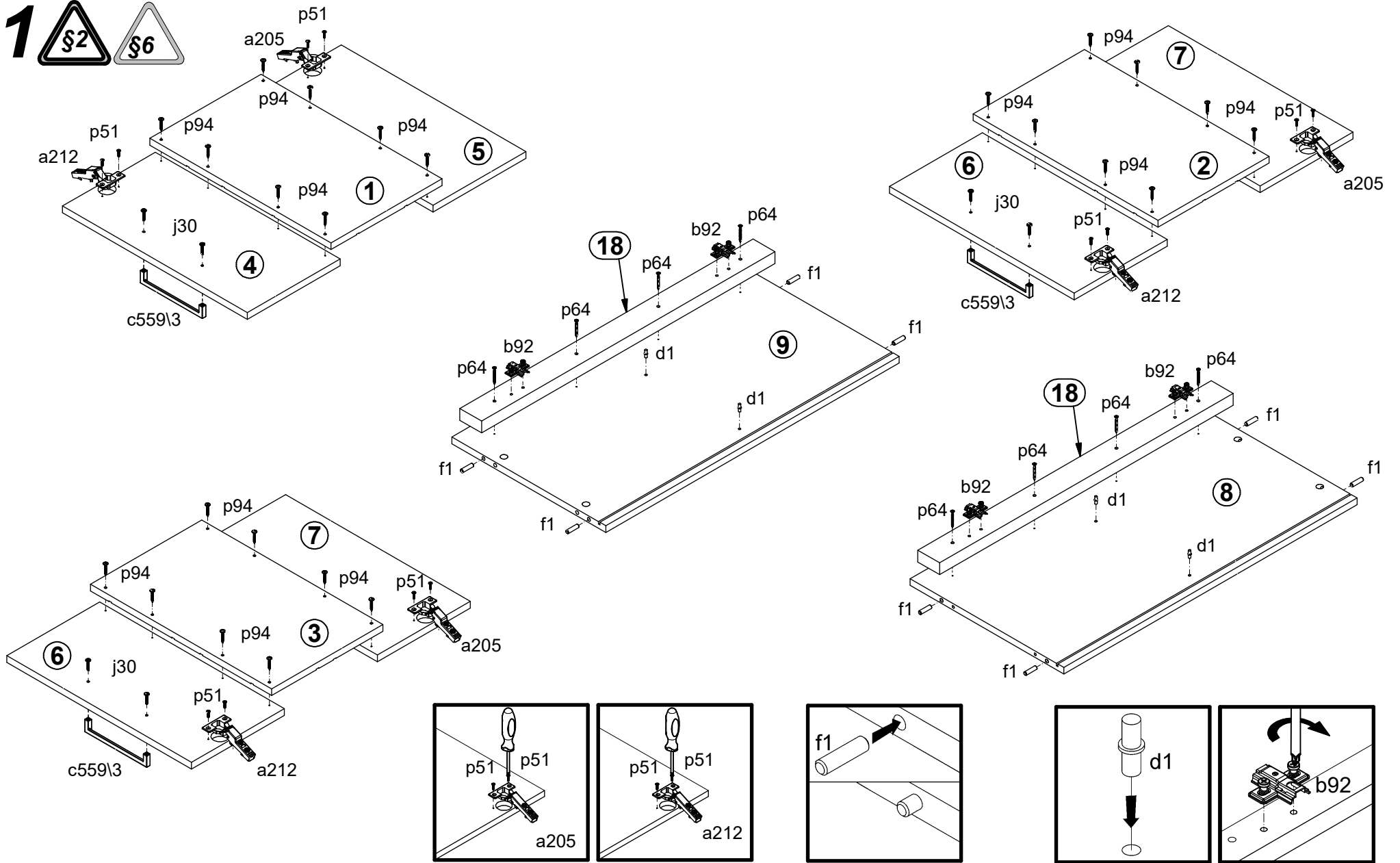

D
3/3

| | | | | | | | | | | | | |
|------------|------------|------------|--------------|-----------|------------|------------|-----------|----------|-----------|-----------|------------|-----------|
| 3x a205 | 3x a212 | 6x b92 | 3x c559/3 | 12x d1 | 8x e1 | 32x f1 | 6x j30 | 8x k1 | 10x l2 | 1x n26 | 8x n108 | 1x p38 |
| 12x p51 | 8x p55 | 18x p64 | 24x p94 | 20x r1 | 20x r42 | 13x s59 | 8x s68 | 1x z1 | | | | |

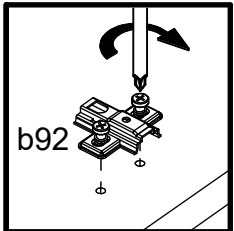
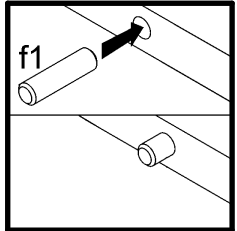
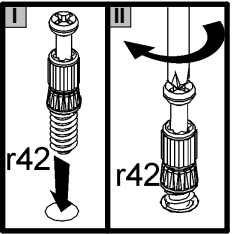
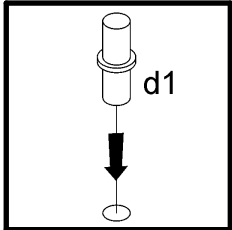
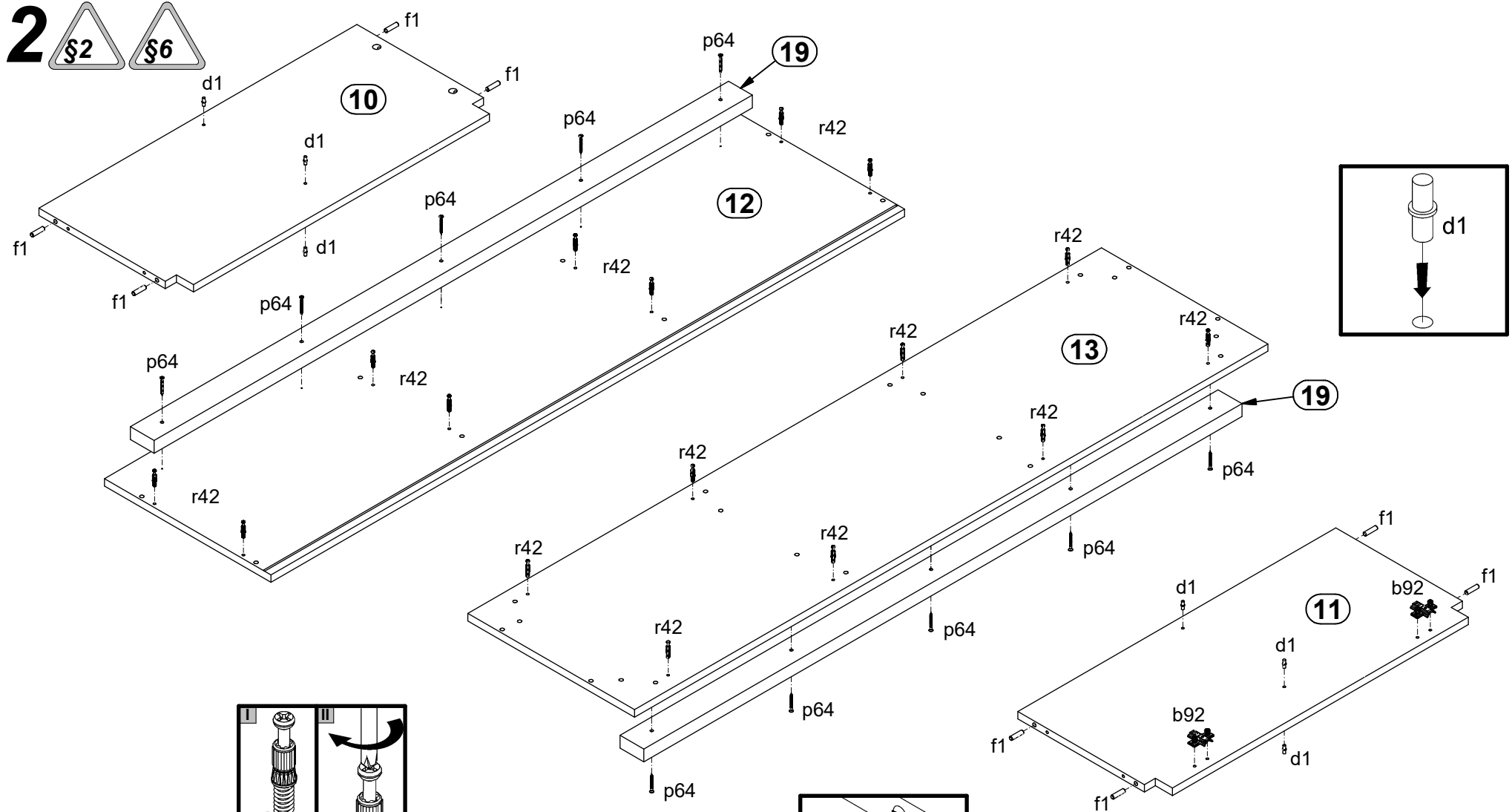

- 3x a205
- 3x a212
- 4x b92
- 3x c559\3
- 4x d1
- 8x f1
- 6x j30
- 12x p51
- 8x p64
- 24x p94



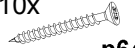
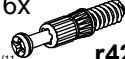

- 2x  **b92**
- 8x  **d1** Ø5x17 mm
- 8x  **f1** Ø8x30 mm
- 10x  **p64** Ø4x40 mm
- 16x  **r42** 20/11

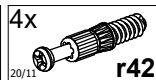
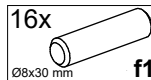
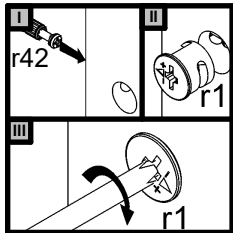
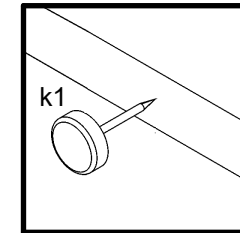
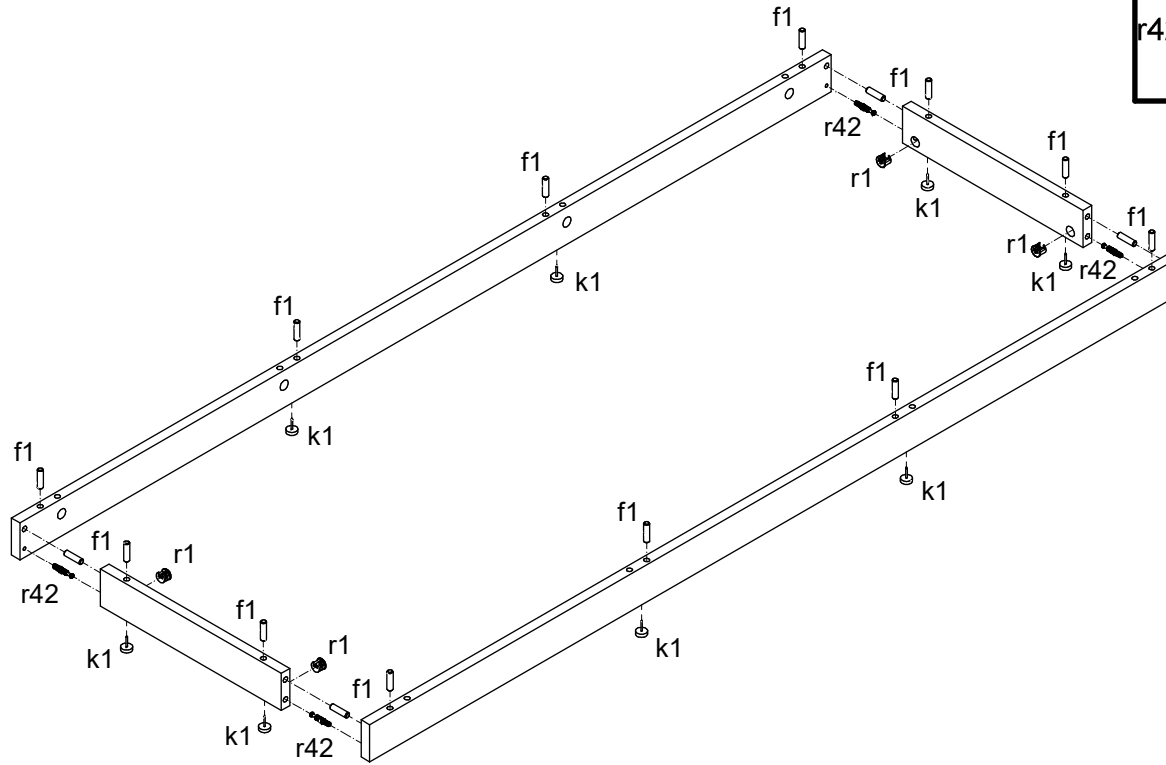
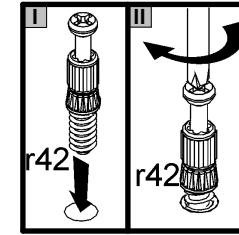
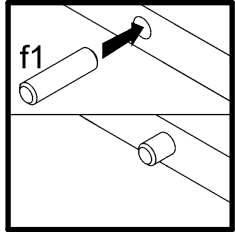
3  

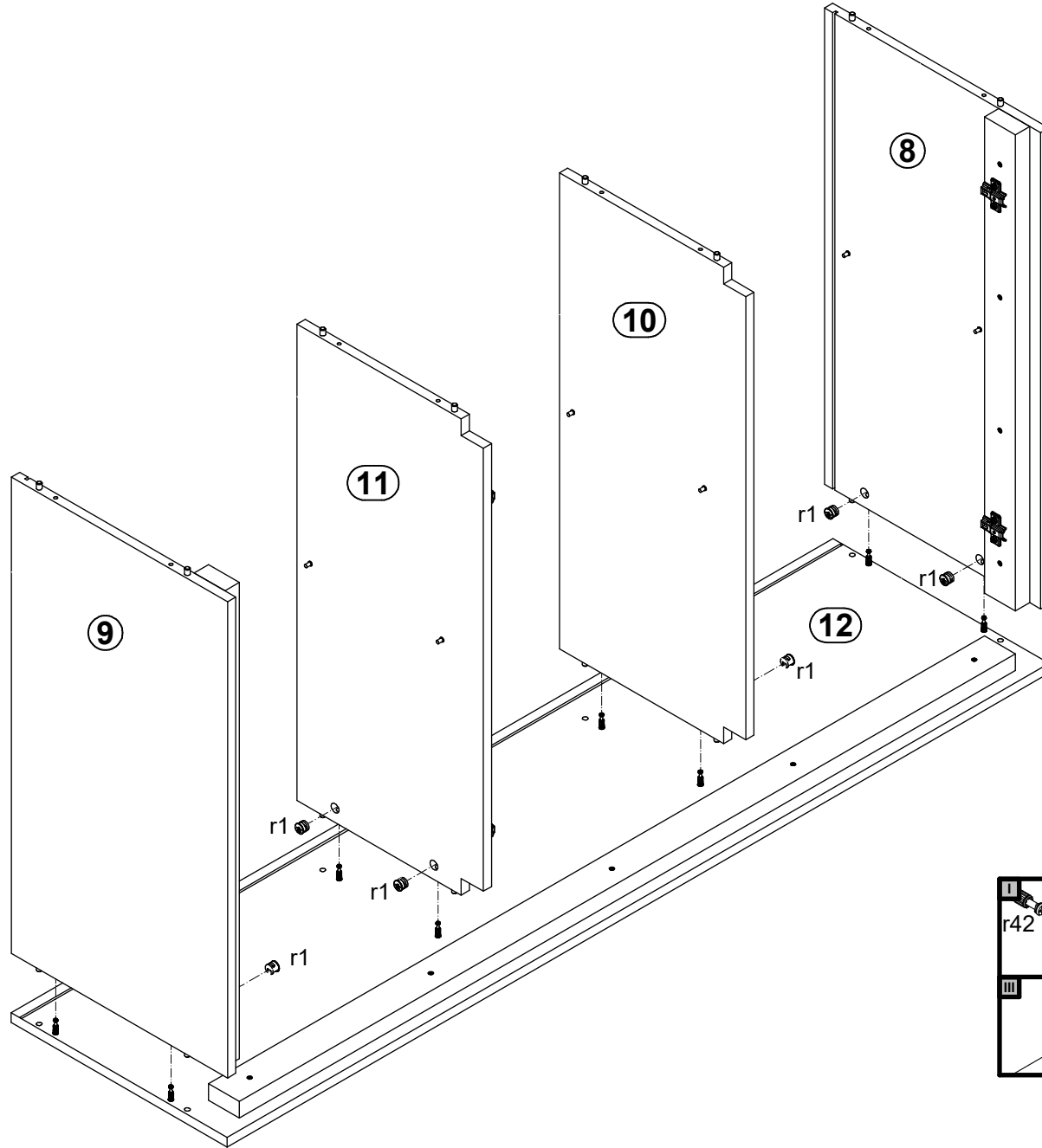

4 



8x  r1
Ø15x12 mm #16

5 

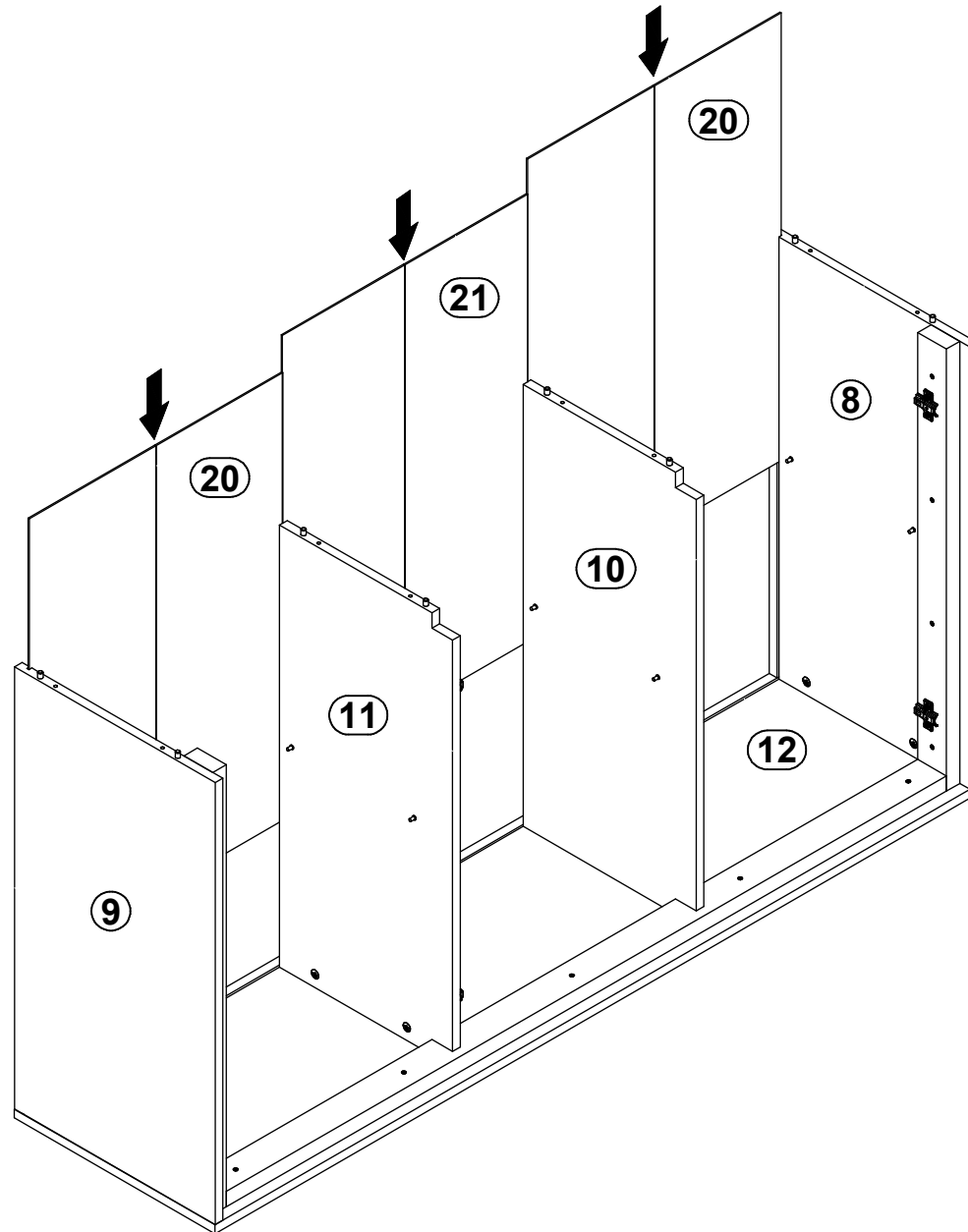

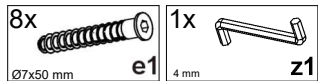
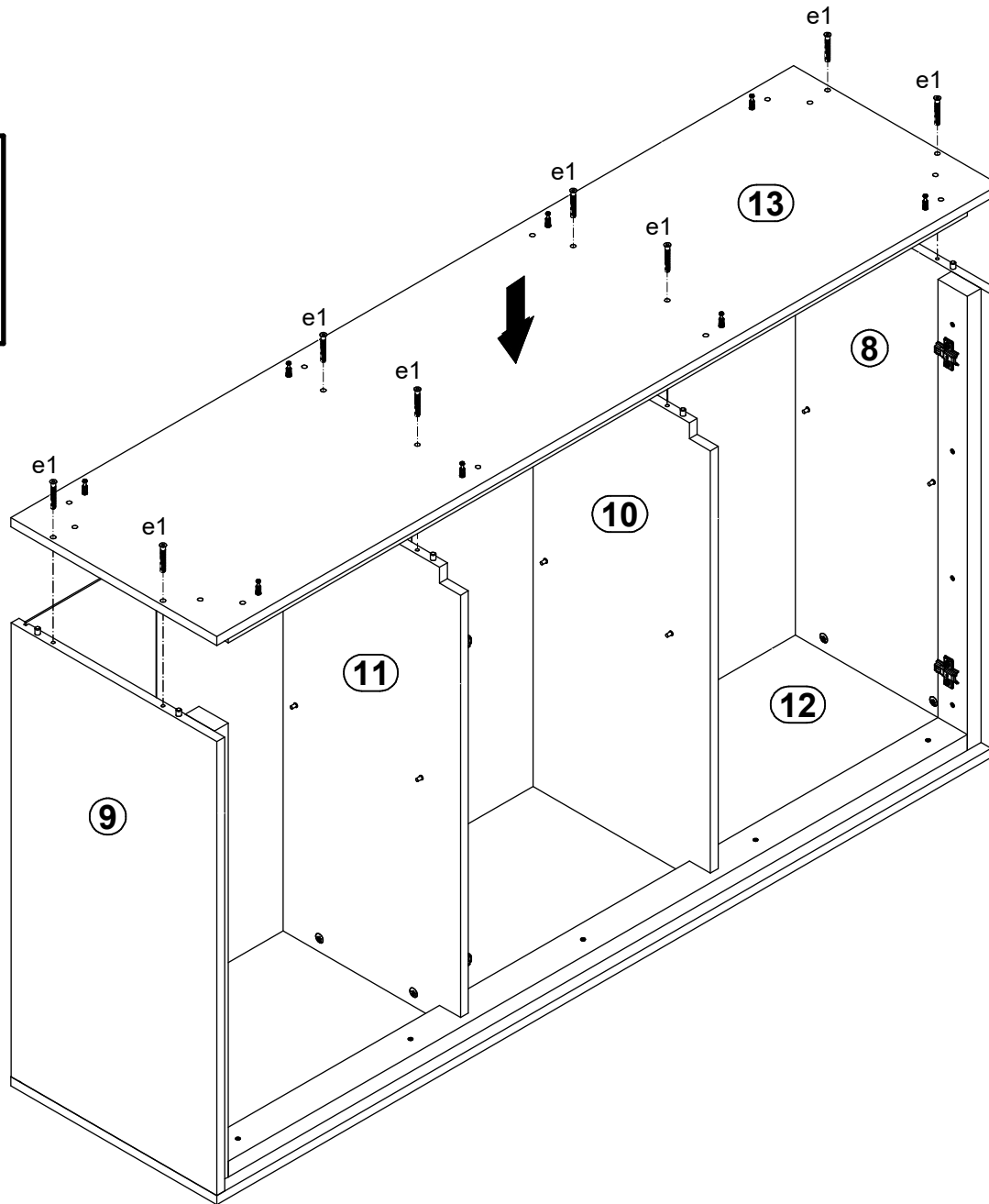
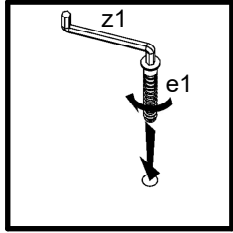

6 

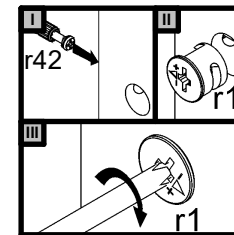
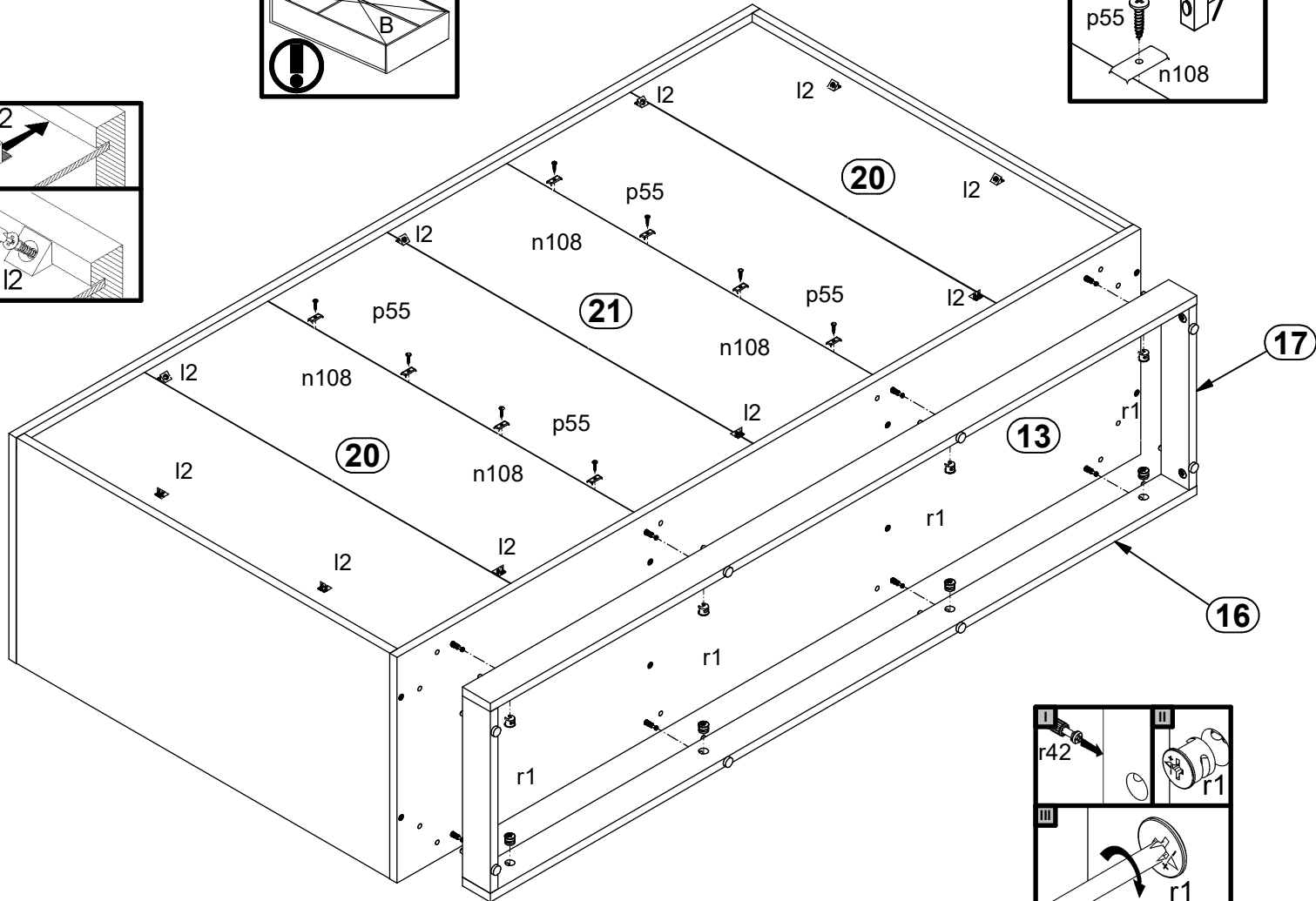
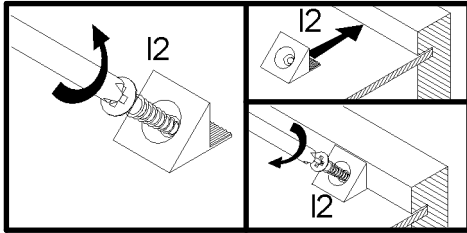
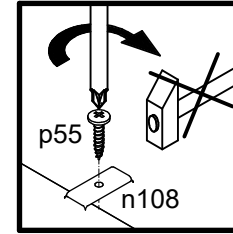
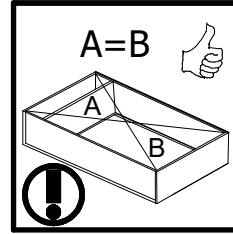

7  

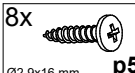
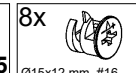

- 10x  l2
- 8x  n108
- 8x  p55
- 8x  r1

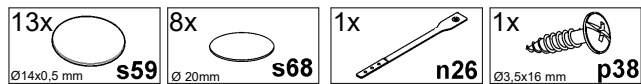
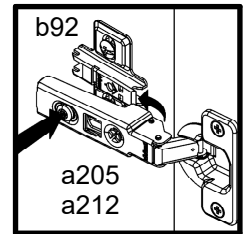
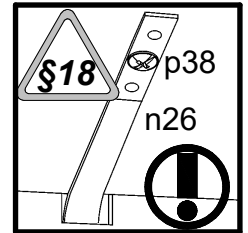
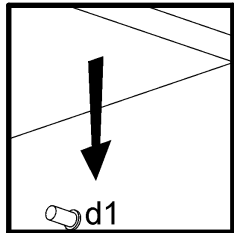
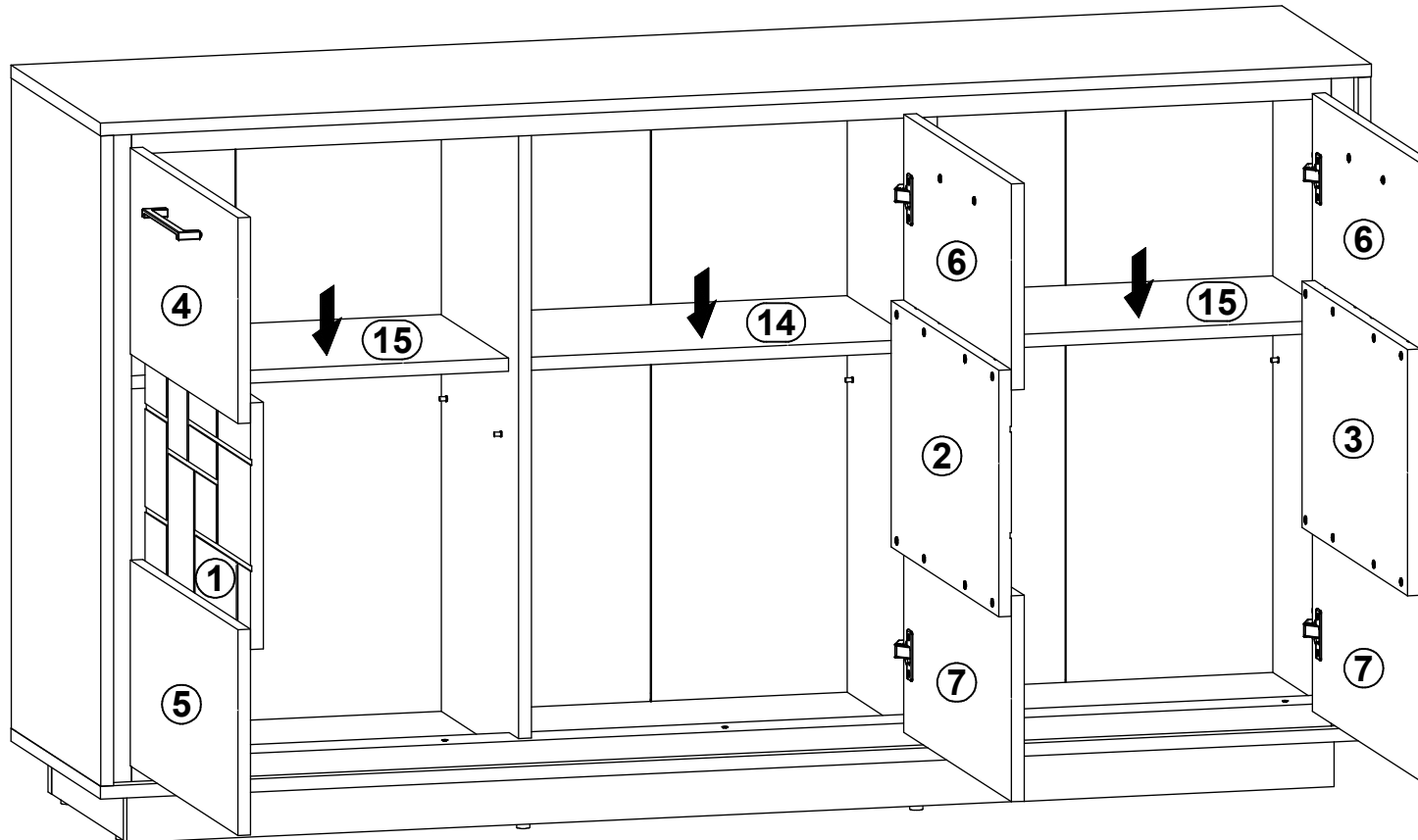
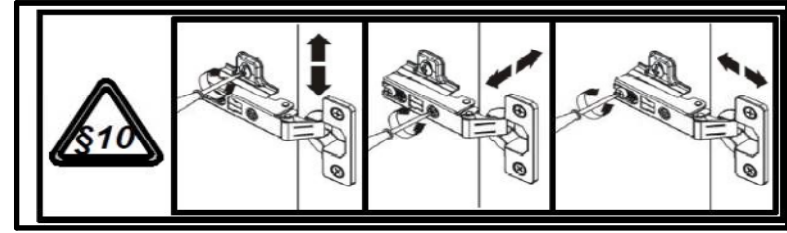
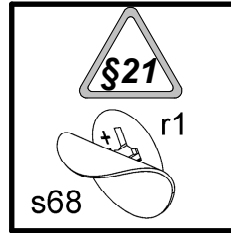
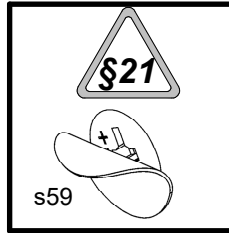

9

