

A	B	C (mm)			D
1	S611-1014	2000	300	22	4/6
2	S611-1015	2000	300	22	4/6
3	S611-4002	2000	271	18	3/6
4	S611-4003	2000	271	18	3/6
5	S611-4004	149	100	15	3/6
6	S611-4007	1650	925	34	2/6
7	S611-4008	1650	549	34	1/6
8	S611-4011	1266	271	18	3/6
9	S611-5036	1680	60	22	1/6
10	S611-9004	1264	989	6	3/6

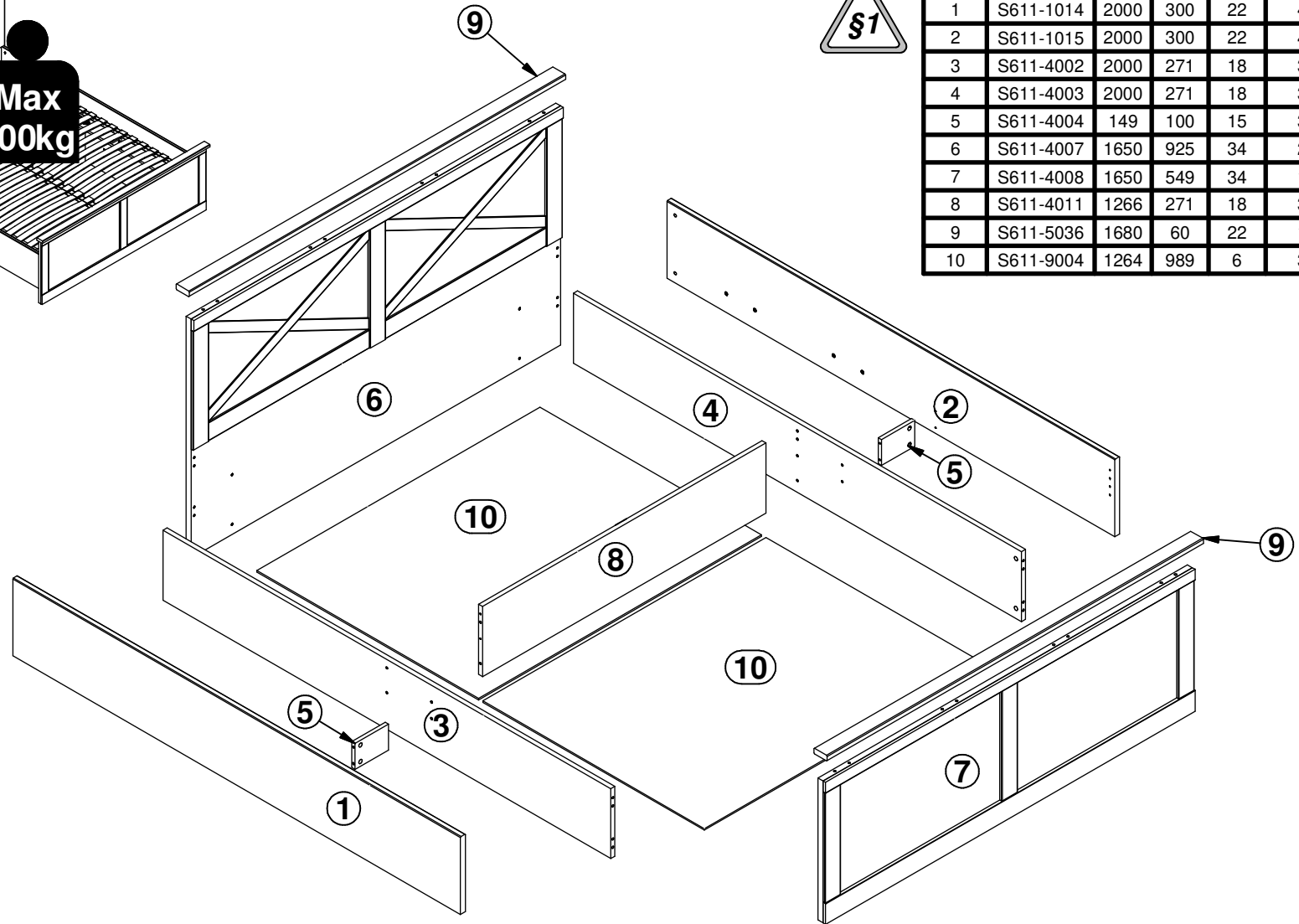

D
1/6

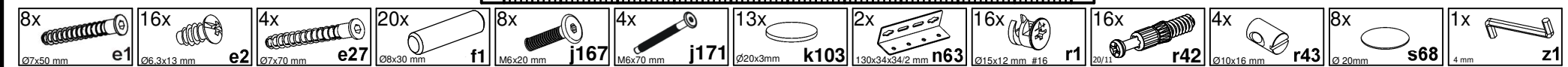

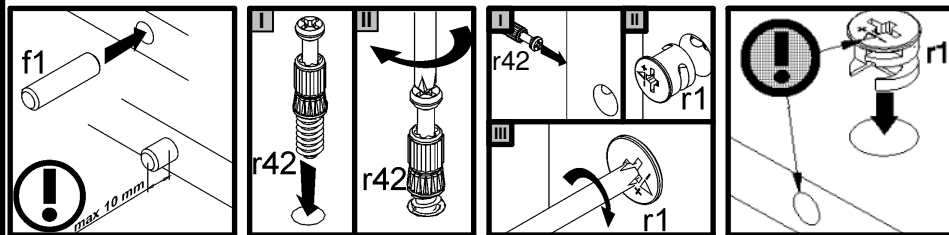
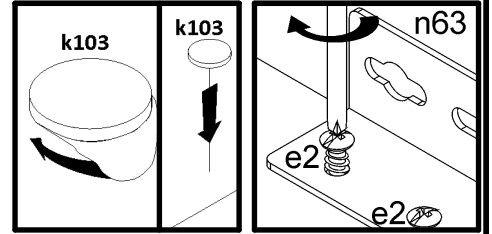
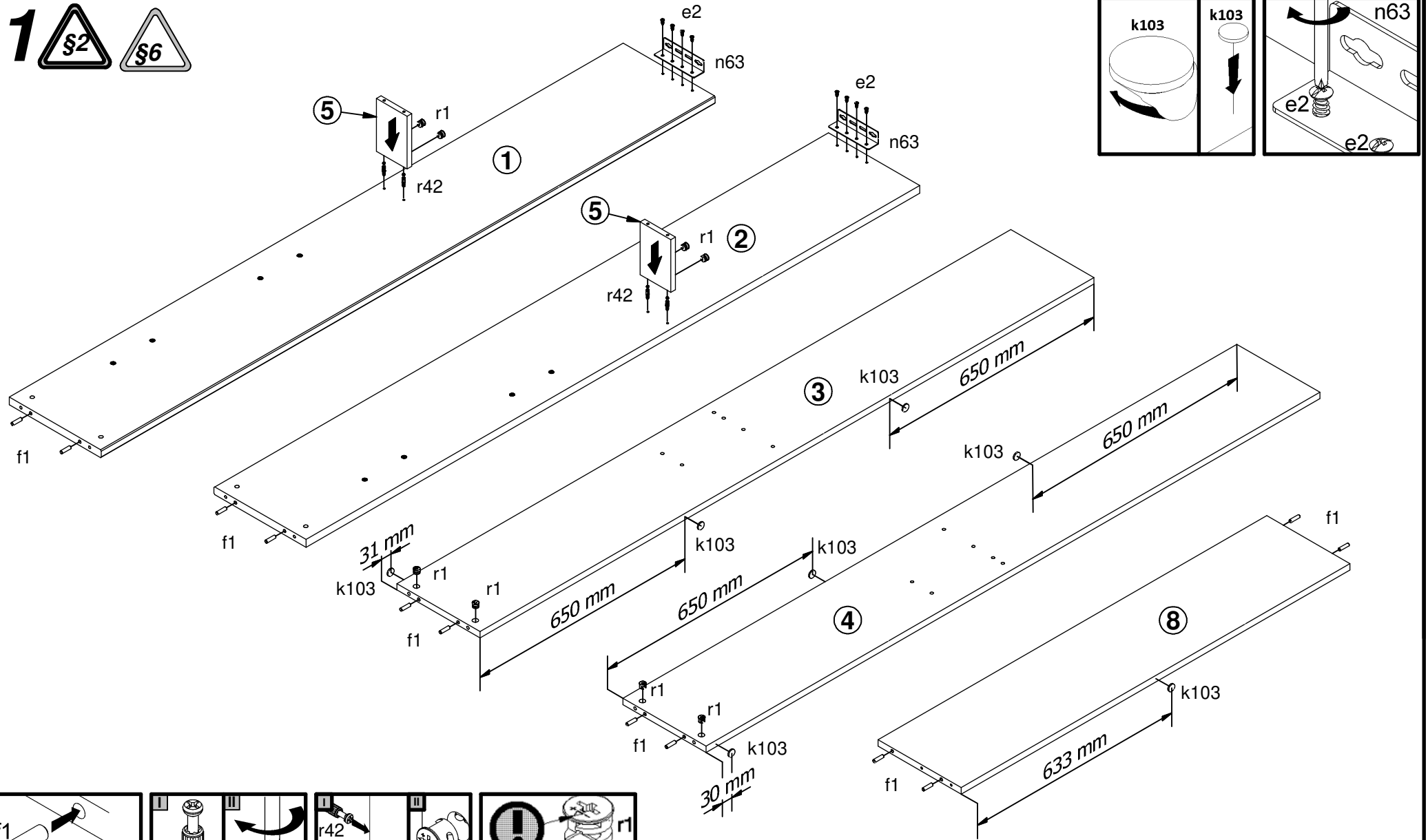



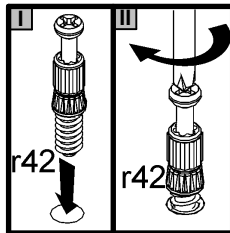
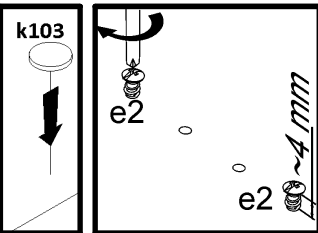
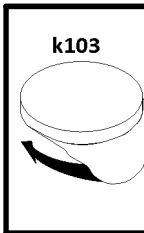
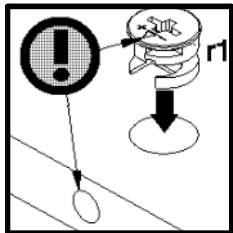
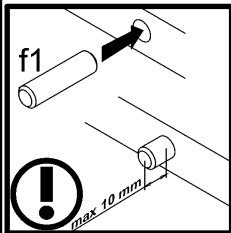
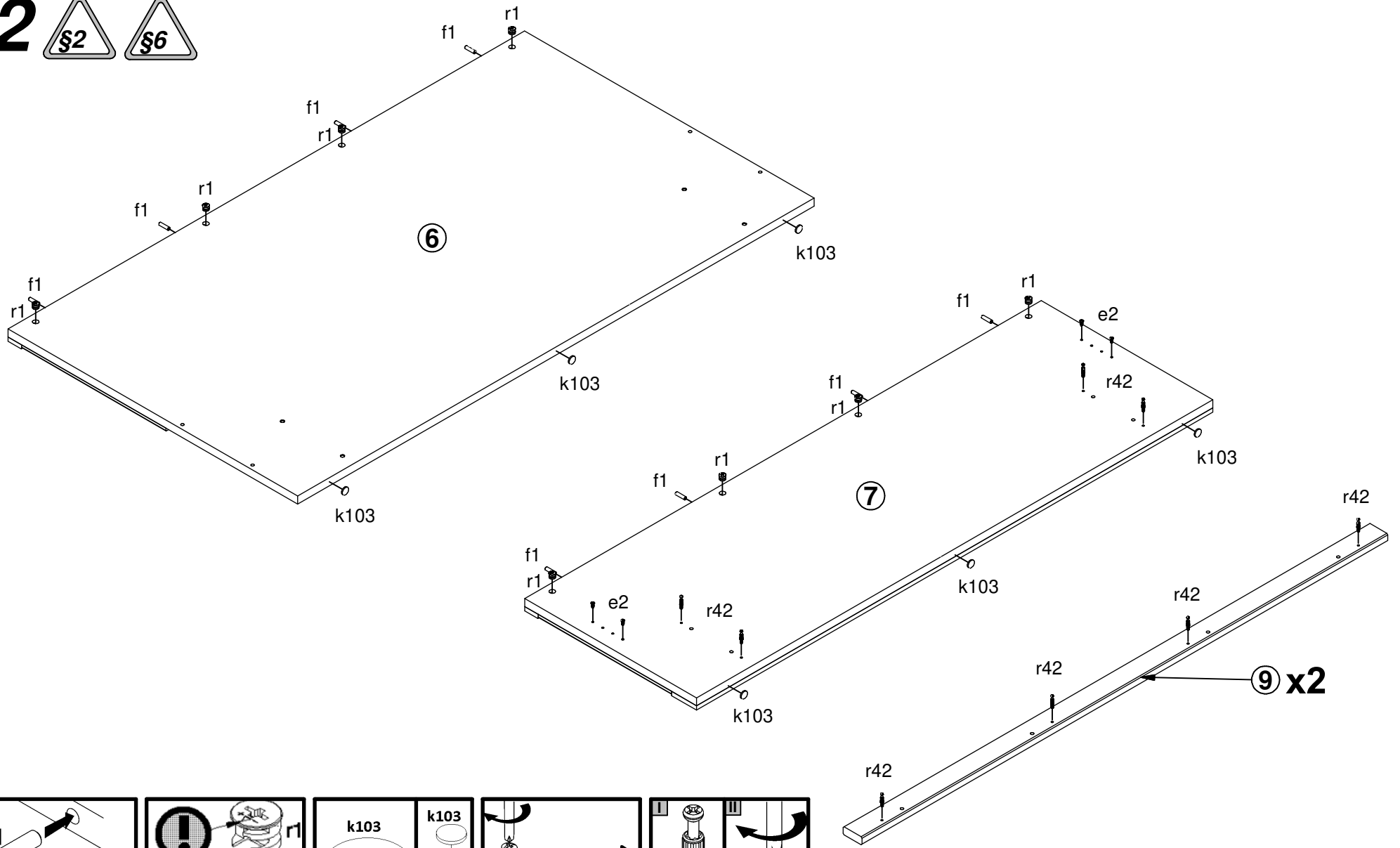

8x Ø6.3x13 mm e2	12x Ø8x30 mm f1	6x Ø20x3mm k103	2x 130x34x34/2 mm n63	8x Ø15x12 mm #16 r1	4x 20/11 r42
------------------------	-----------------------	-----------------------	-----------------------------	---------------------------	--------------------

2  



4x  Ø6.3x13 mm e2	8x  Ø8x30 mm f1	6x  Ø20x3mm k103	8x  Ø15x12 mm #16 r1	12x  20/11 r42
--	--	---	---	---

3 

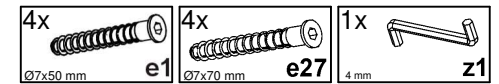
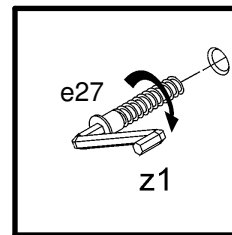
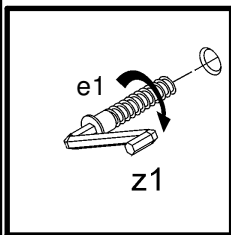
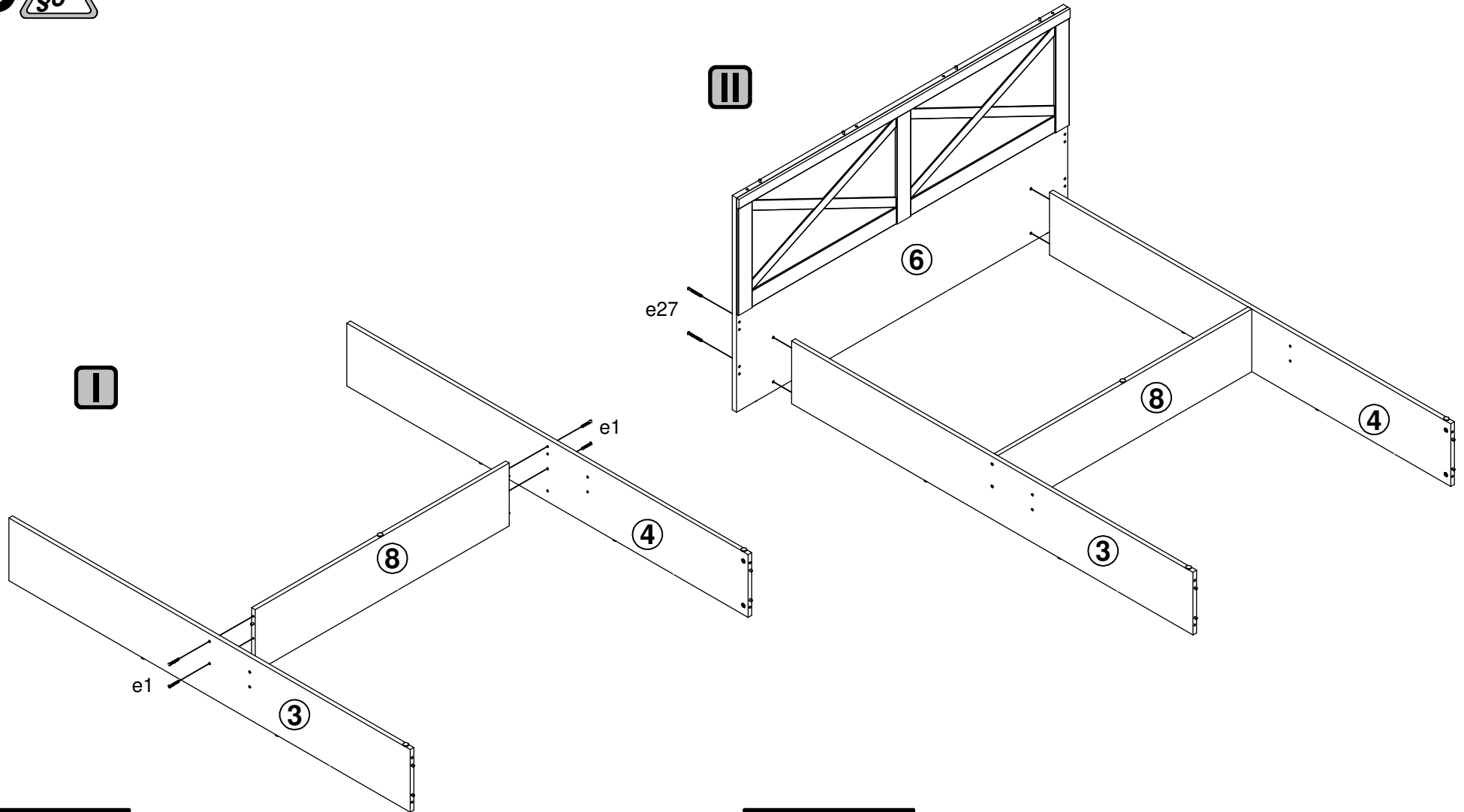

4 

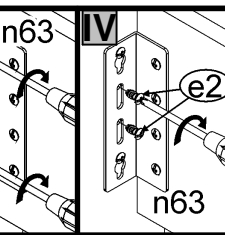
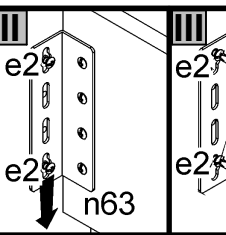
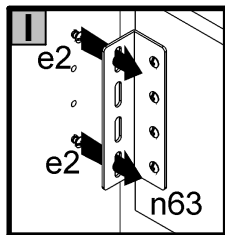
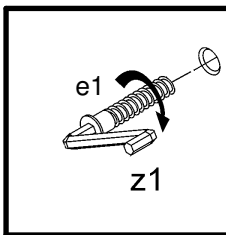
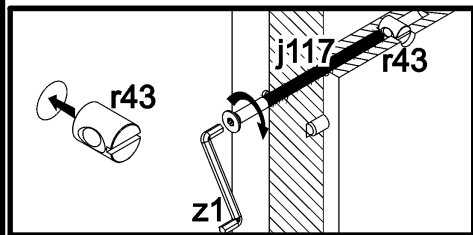
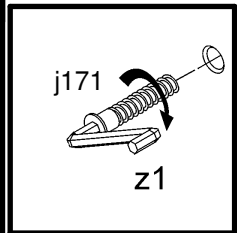
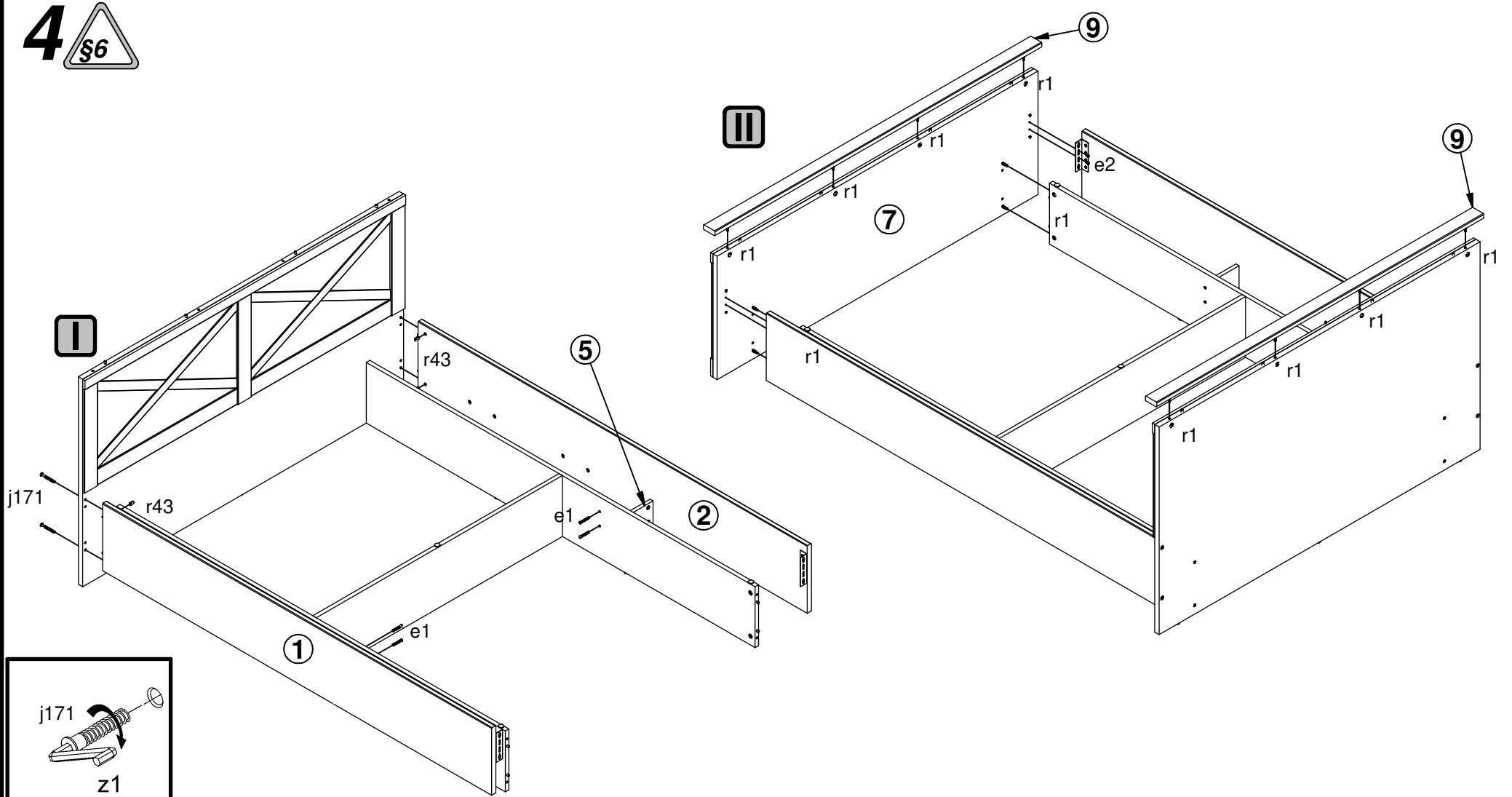

4x Ø7x50 mm e1	4x Ø6,3x13 mm e2
4x M6x70 mm j171	4x Ø10x16 mm r43

5 §6

