

LOKSA

S455-SZF2D3M

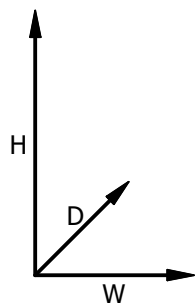

H - 2199 mm
W - 2378 mm
D - 571 mm

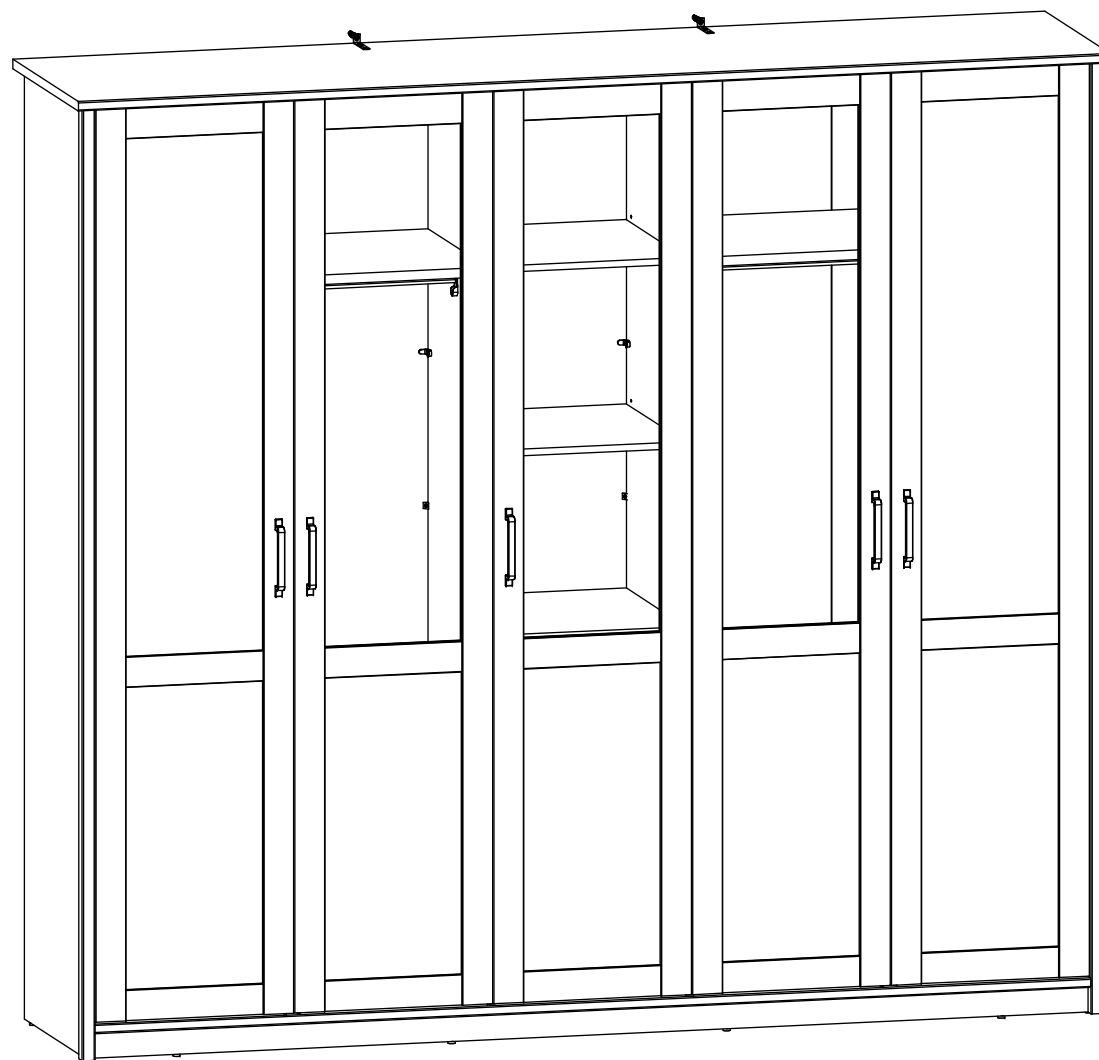
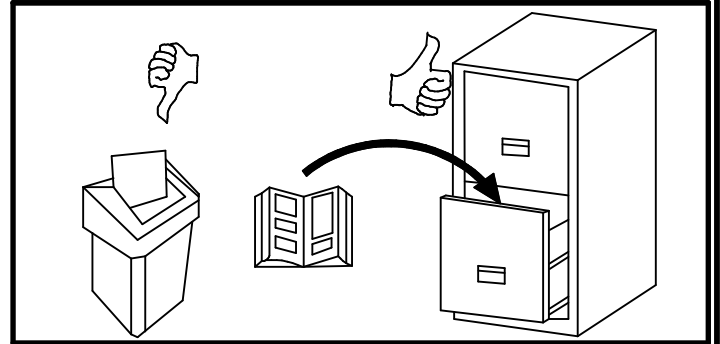
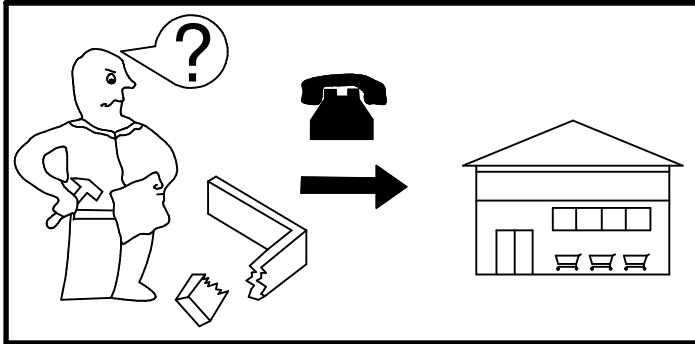
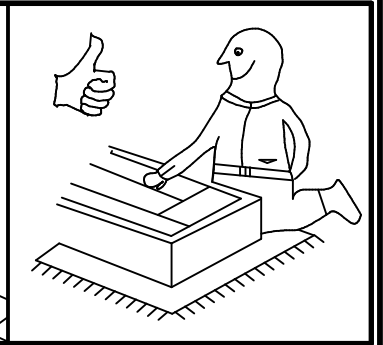
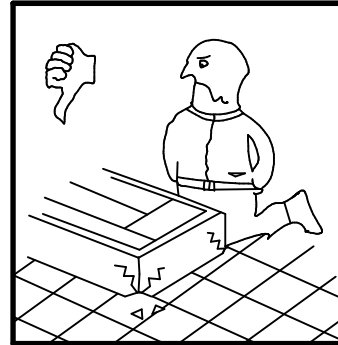
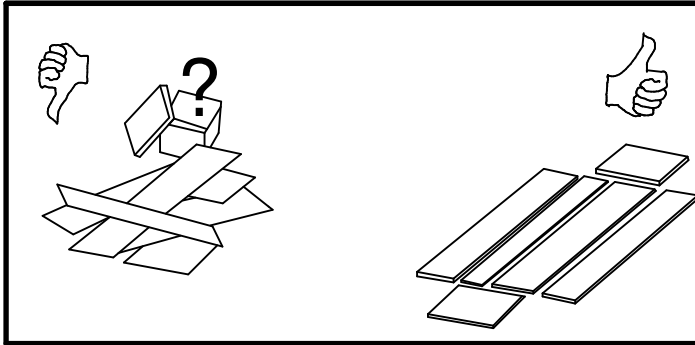
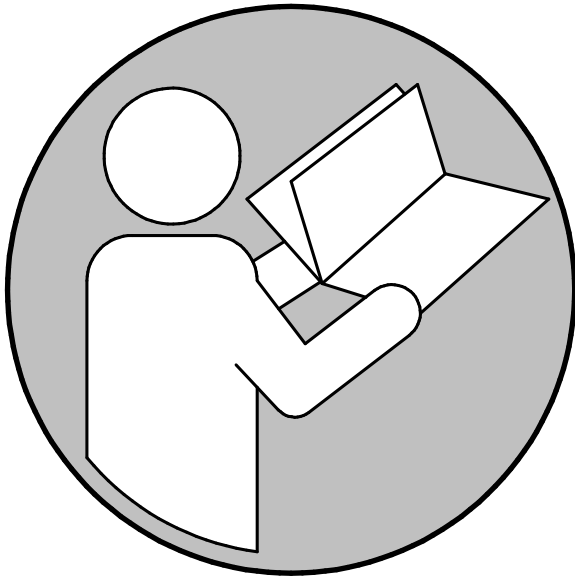

§1

§2

→

□	□	□	□
▲	Opisne zasady montazu mebla		
▲	Opisne zasady montazu mebla		
▲	Opisne zasady montazu mebla		
▲	Opisne zasady montazu mebla		
▲	Opisne zasady montazu mebla		
▲	Opisne zasady montazu mebla		
▲	Opisne zasady montazu mebla		
▲	Opisne zasady montazu mebla		
▲	Opisne zasady montazu mebla		
▲	Opisne zasady montazu mebla		
▲	Opisne zasady montazu mebla		
□	□	○	○

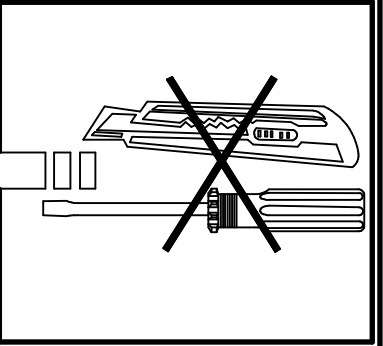
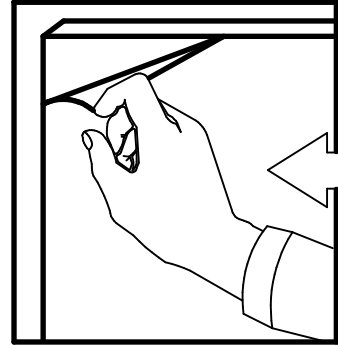
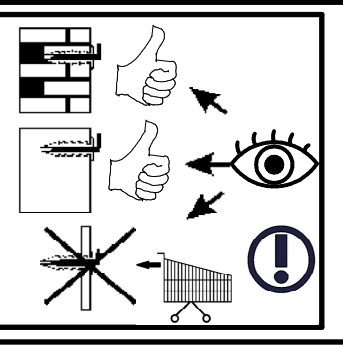
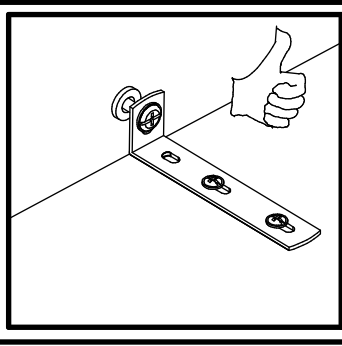
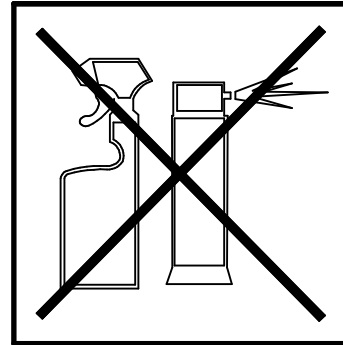
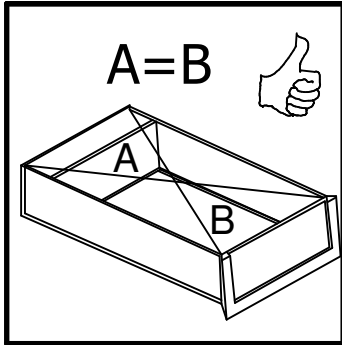

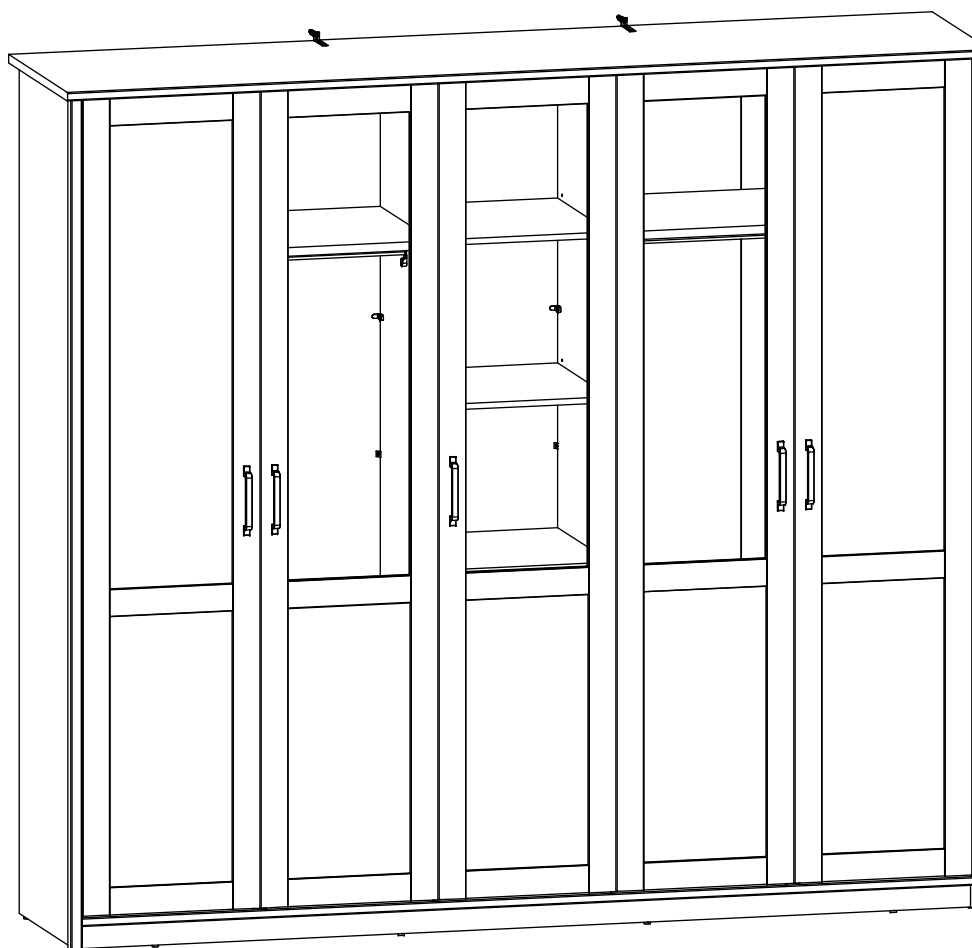
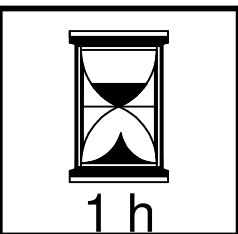
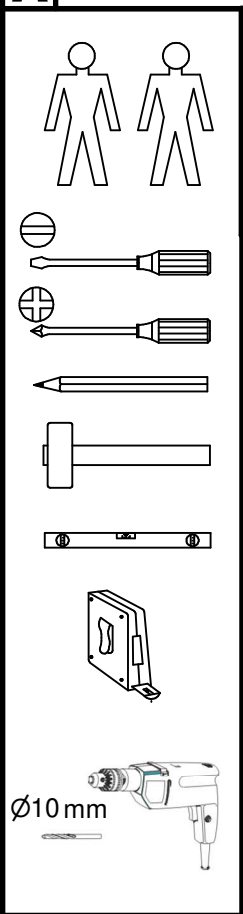

5x a133	12x a159	8x a160	20x b43	cm 0 1 2 3 4 5 6 7 8 9 10							5x c526	12x d1	16x d20	<table border="1"><tr><td>D</td></tr><tr><td>5/6</td></tr></table>	D	5/6
D																
5/6																
12x d28	4x d5	8x e1	40x e2	16x e50	12x e51	16x f1	2x f35	12x k1	4x l63	12x l2	4x n267	2x n142				
2x p17	52x p51	10x p9	24x r1	24x r42	8x s1	24x s68	1x z1									



A	B	C (mm)			D	A	B	C (mm)			D
1	S455-0030	2084	460	19	6/6	10	S455-3033	2318	557	22	3/6
2	S455-0031	2084	460	19	6/6	11	S455-3034	919	516	22	5/6
3	S455-0032	2084	460	19	6/6	12	S455-3035	444	516	15	5/6
4	S455-0033	2084	460	19	6/6	13	S455-3036	443	508	15	5/6
5	S455-1035	2172	560	30	1/6	14	S455-4011	2318	60	15	3/6
6	S455-1036	2172	560	30	1/6	15	S455-9022	2106	455	2,5	3/6
7	S455-1037	2090	536	18	2/6	16	S455-9307	2106	929	2,5	3/6
8	S455-1038	2090	536	18	2/6	17	S455-9308	2106	929	2,5	3/6
9	S455-2017	2402	571	22	4/6	18	dr-912	912	30	15	5/6

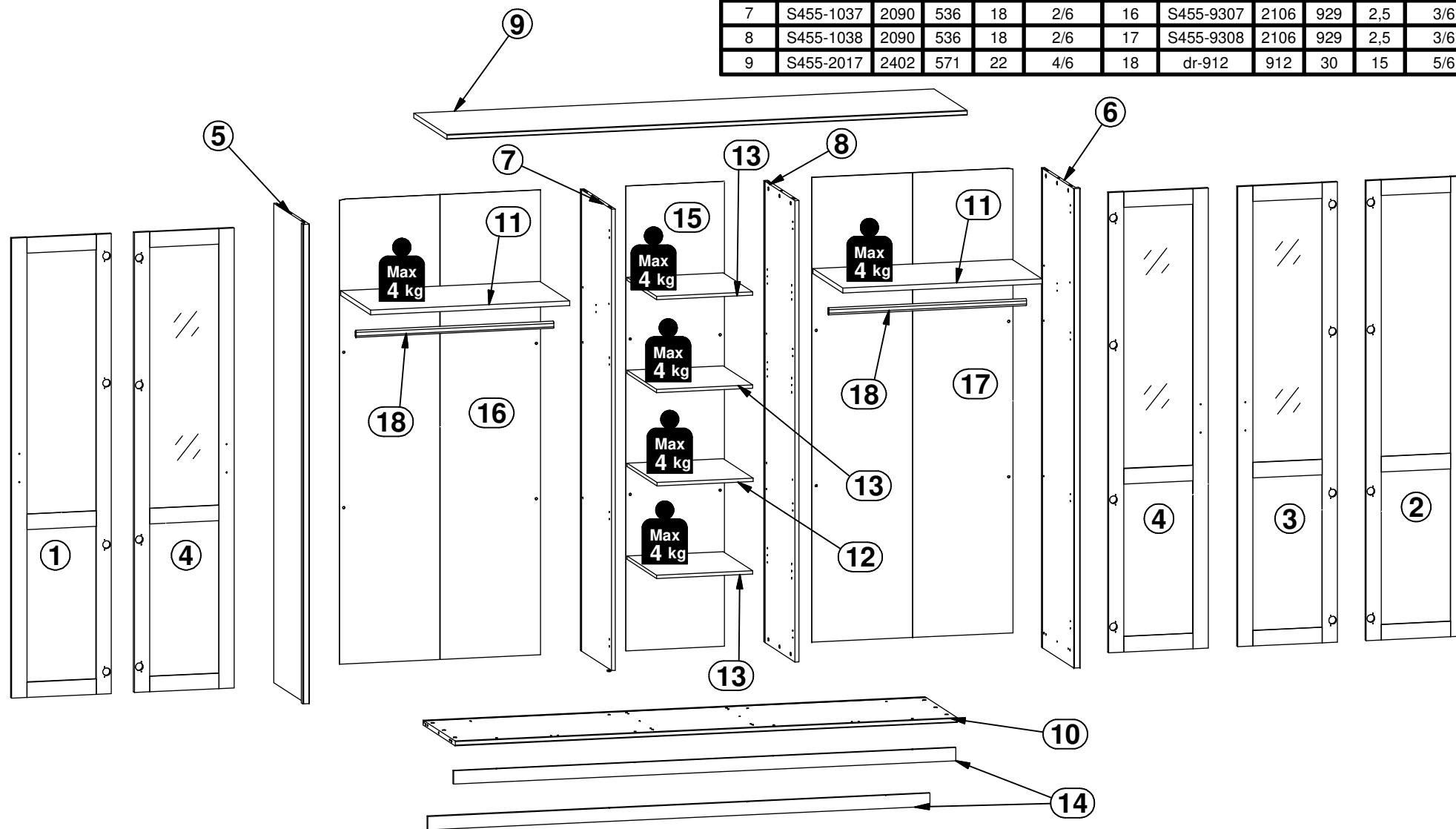

1

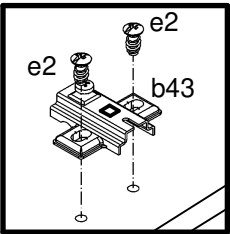
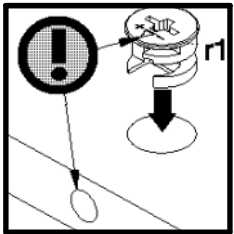
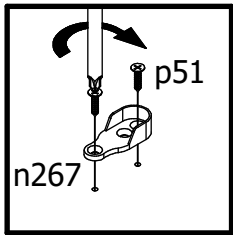
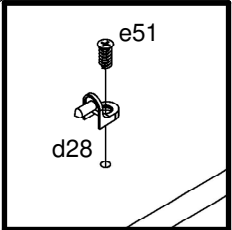
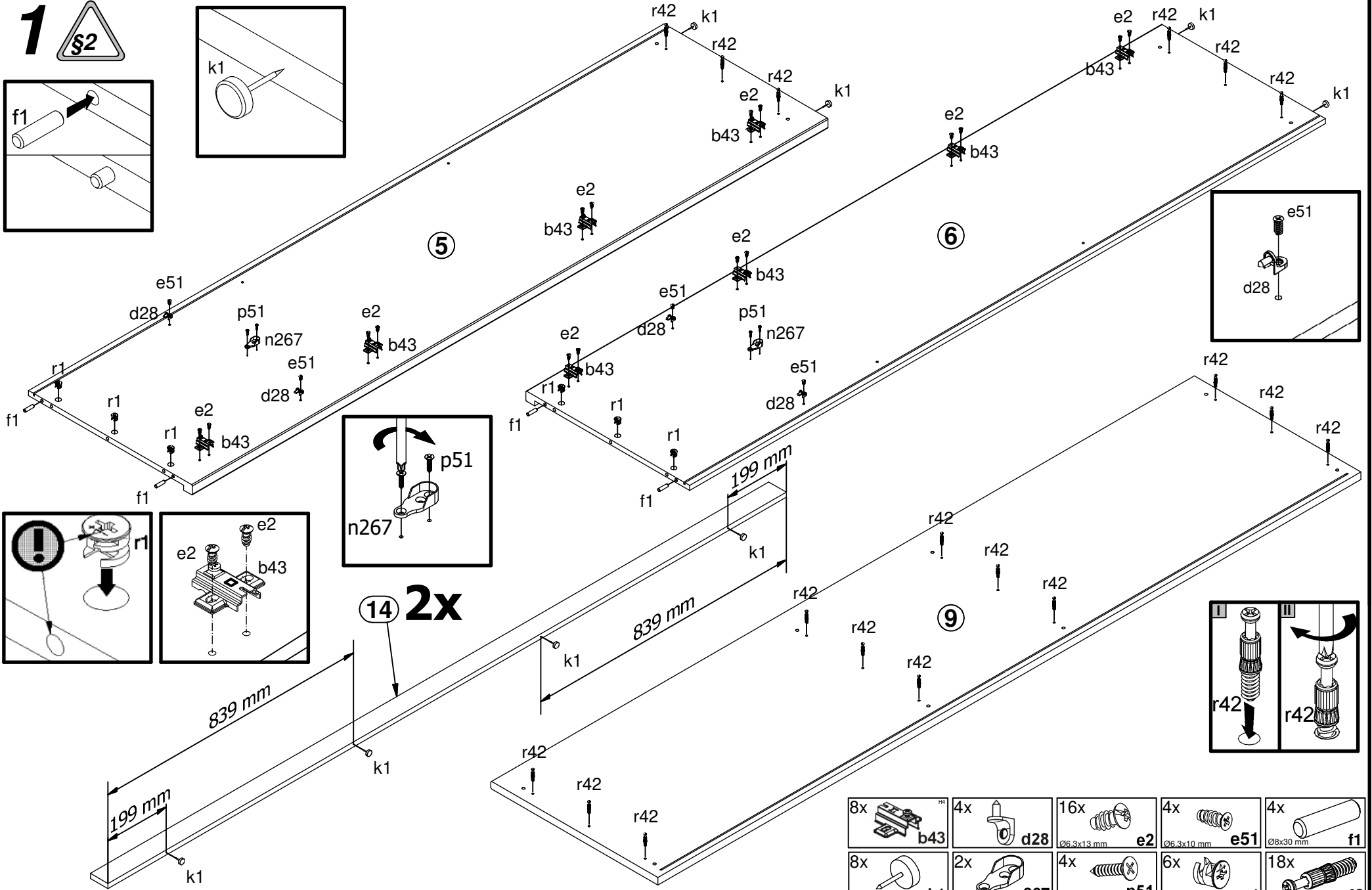
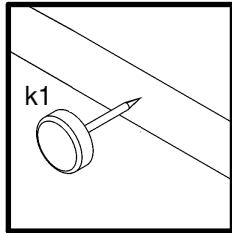
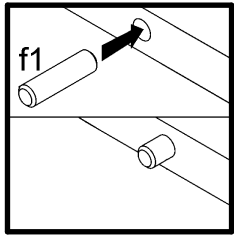



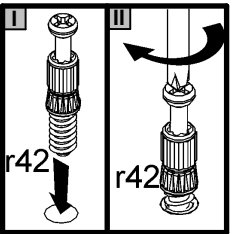

14 2x

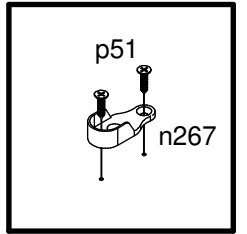
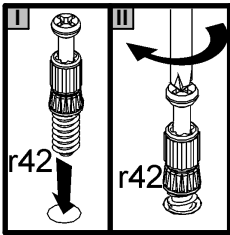
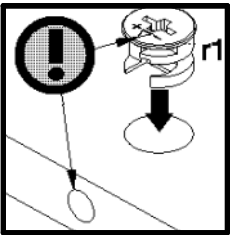
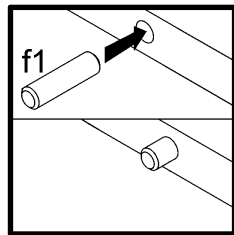
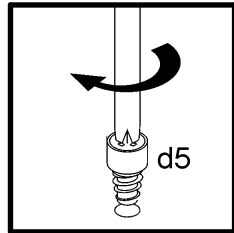
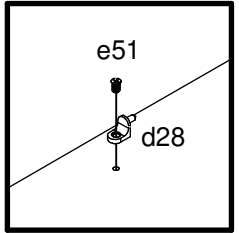
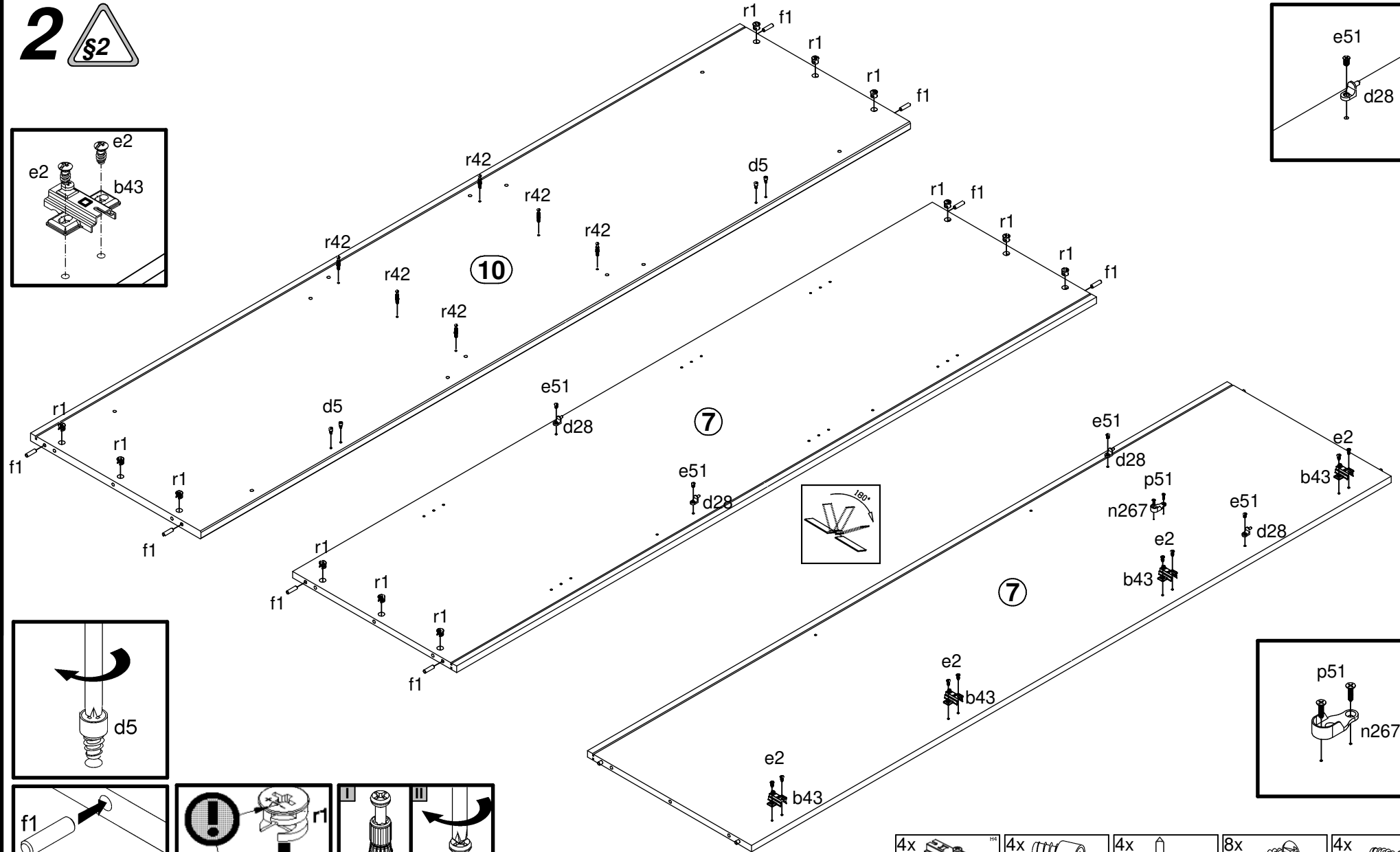
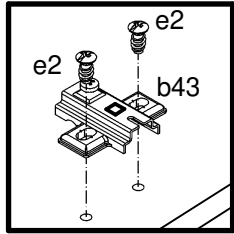

8x	4x	16x	4x	4x
8x	2x	4x	6x	18x
		Ø6.3x13 mm	Ø6.3x10 mm	Ø8x30 mm
		Ø3.5x15 mm	Ø15x12 mm #16	20/11



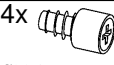
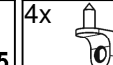
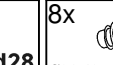
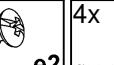
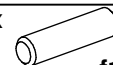

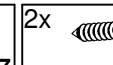
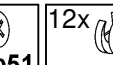
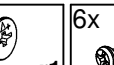

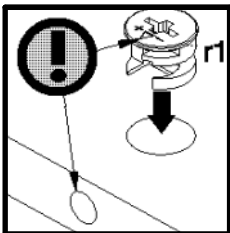
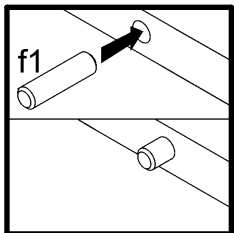
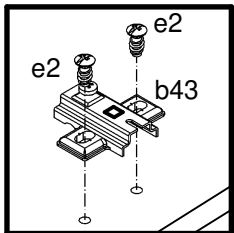
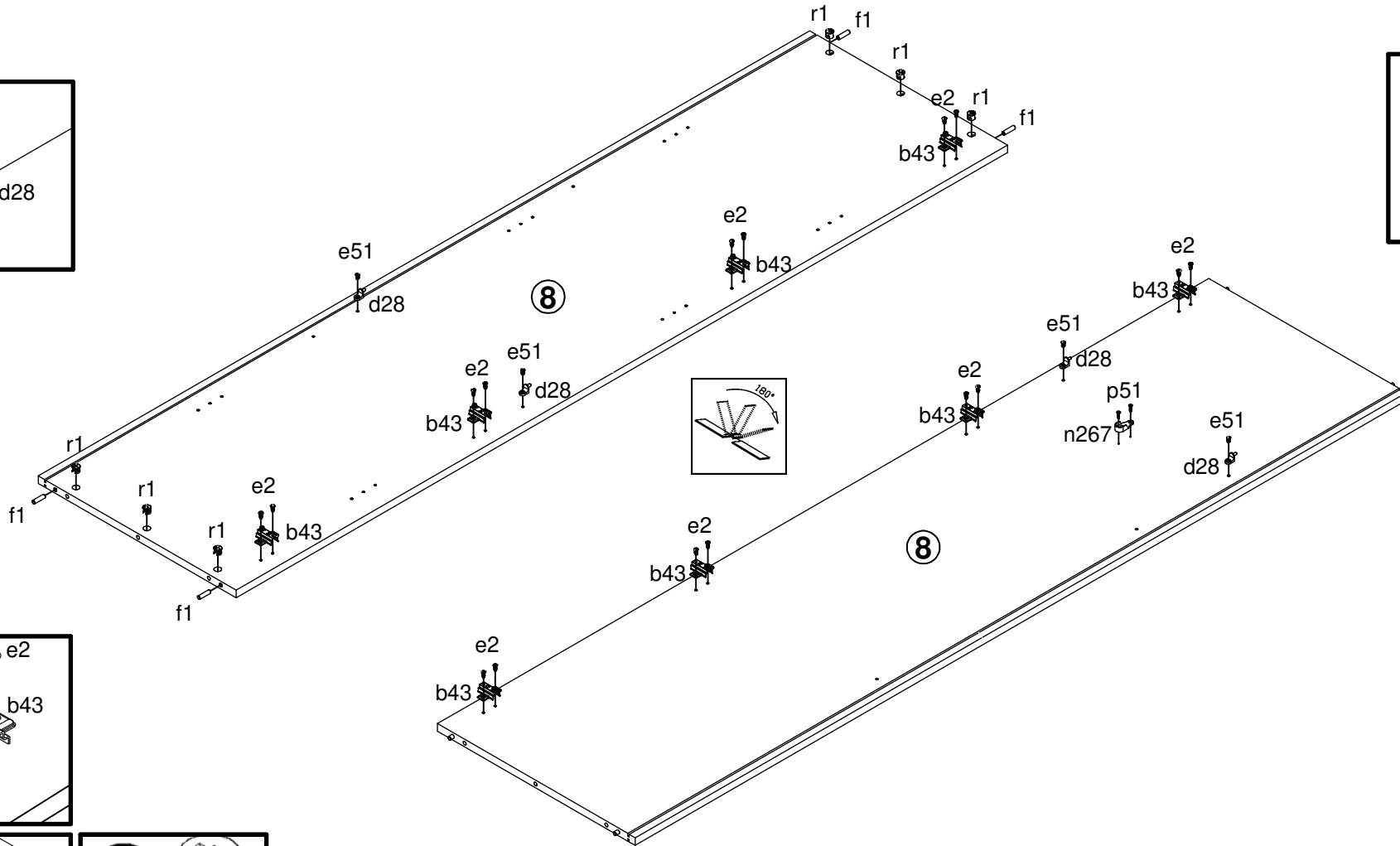
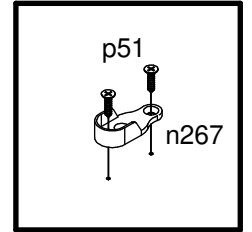
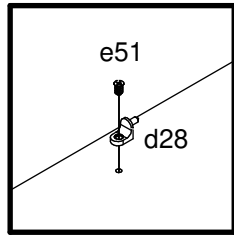

2 



4x  b43	4x  d5 Ø6,3x15 mm	4x  d28	8x  e2 Ø6,3x13 mm	4x  e51 Ø6,3x10 mm
8x  f1 Ø8x30 mm	1x  n267	2x  p51 Ø3,5x15 mm	12x  r1 Ø15x12 mm #16	6x  r42 Ø9/11

3 



8x  b43	4x  r1	16x  e2 Ø6.3x13 mm	4x  e51 Ø6.3x10 mm
4x  f1 Ø8x30 mm	1x  n267	2x  p51 Ø3.5x15 mm	6x  r1 Ø15x12 mm #16

4 

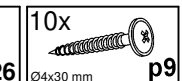
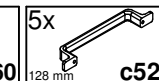
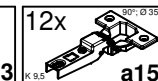
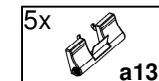
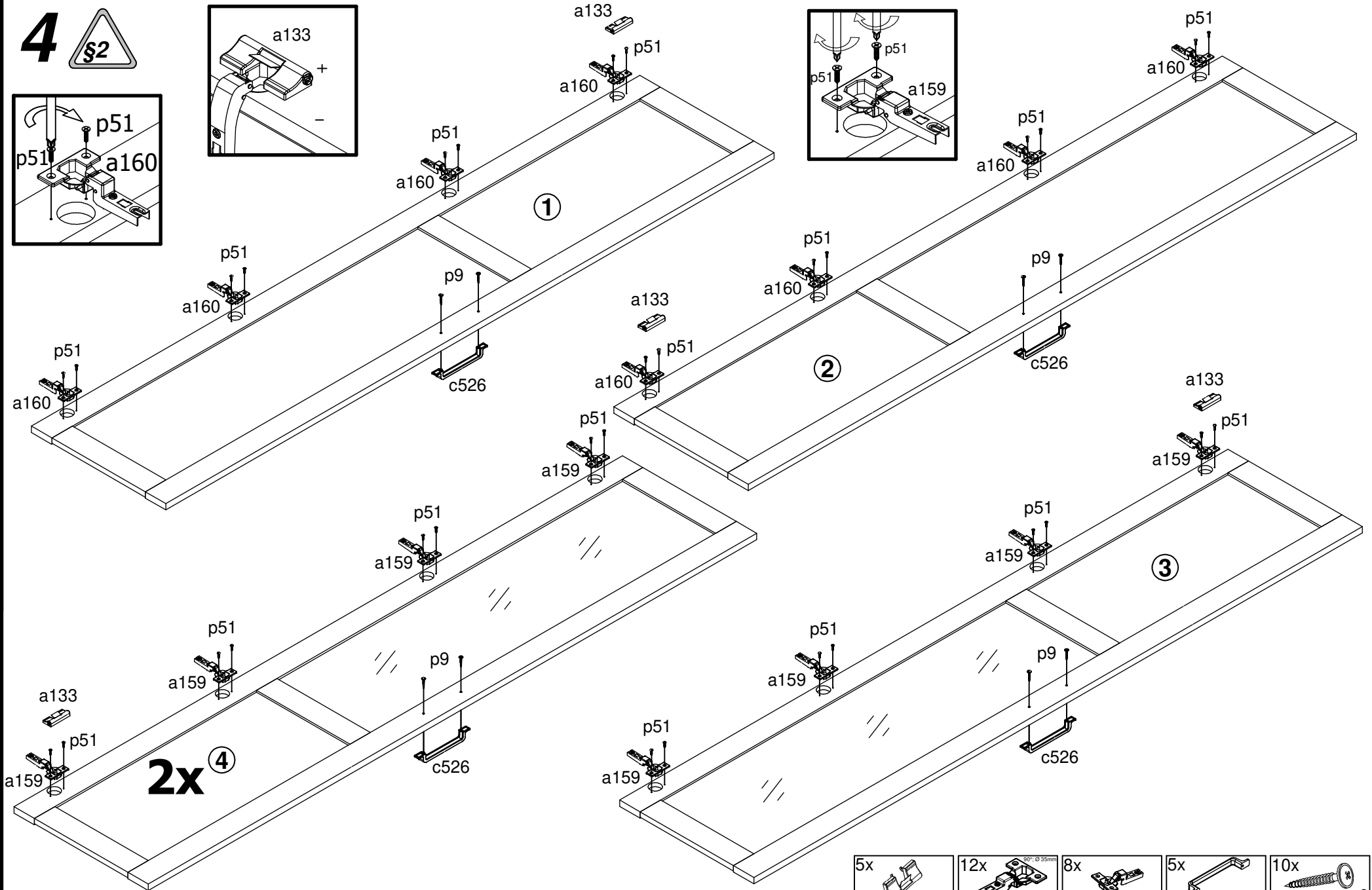
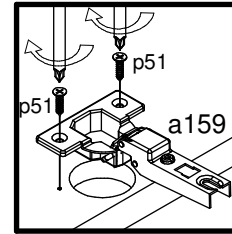
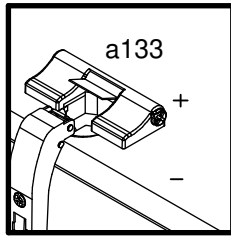
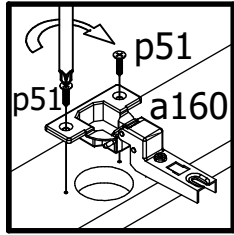

5 

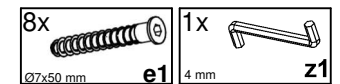
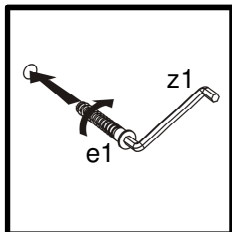
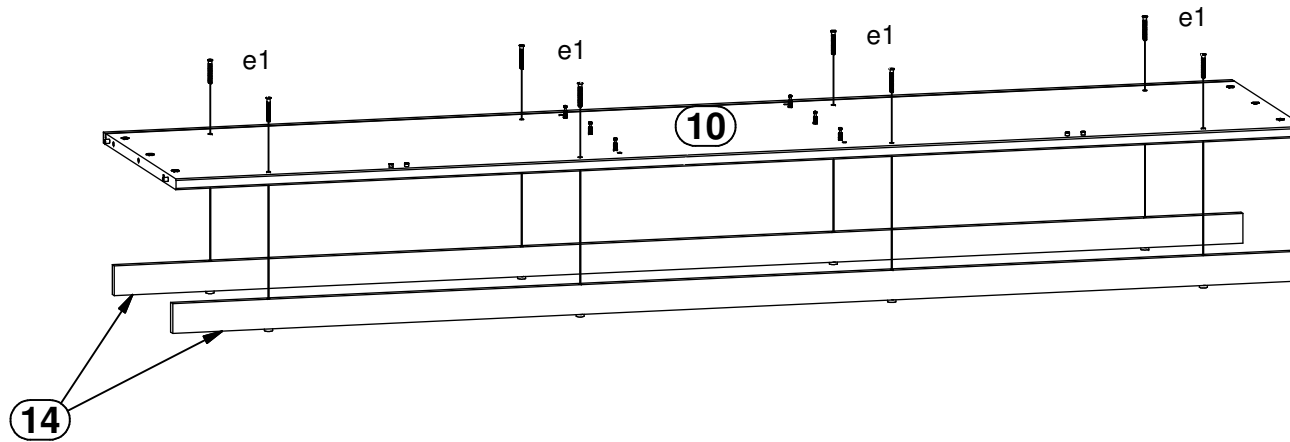

6 

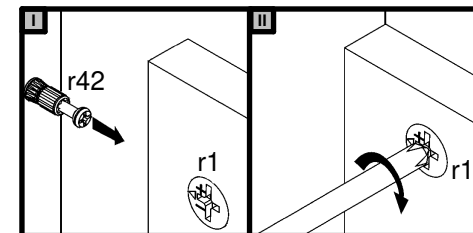
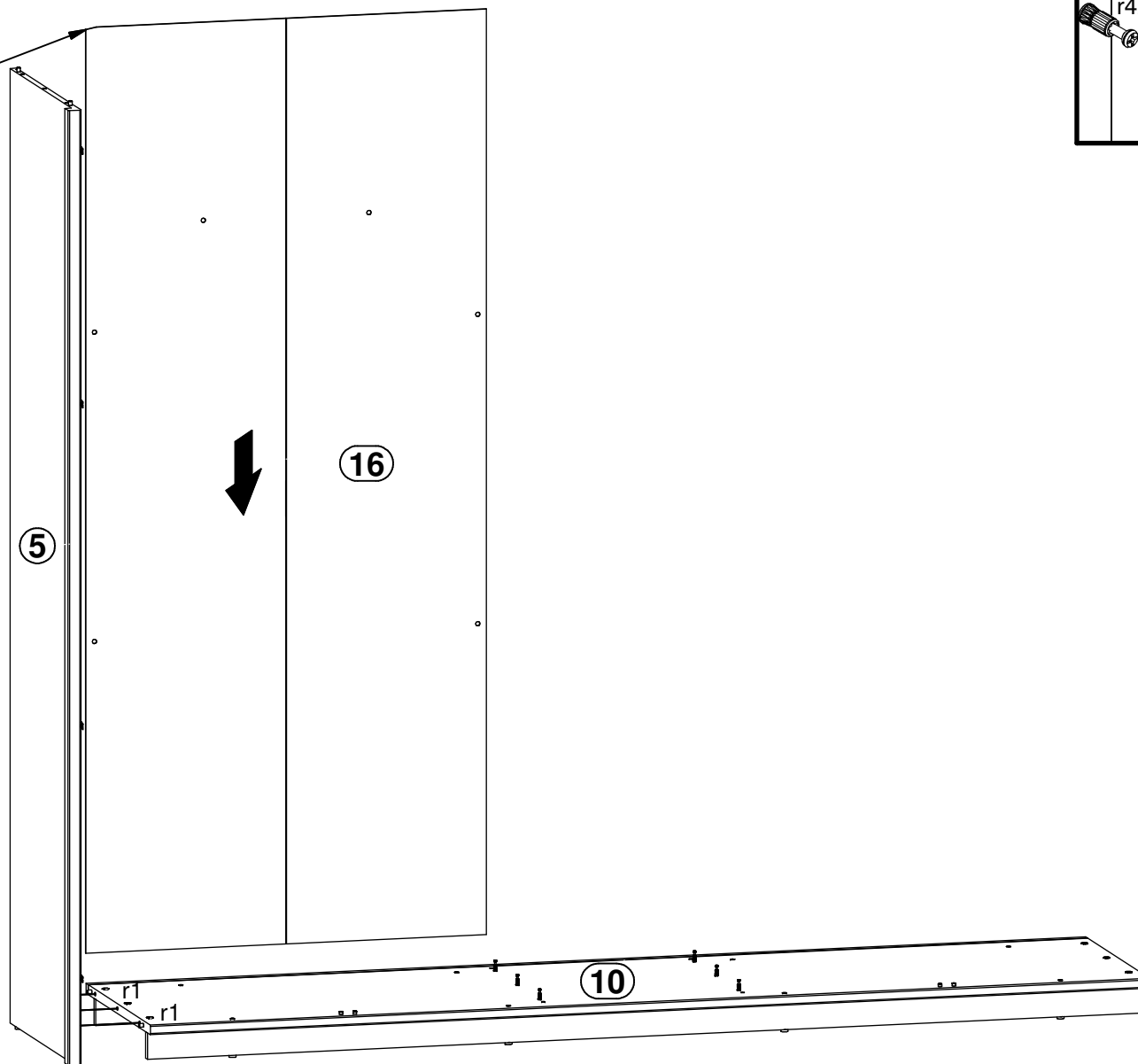
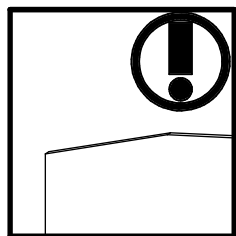

7 

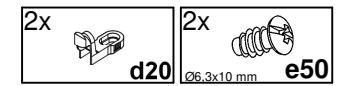
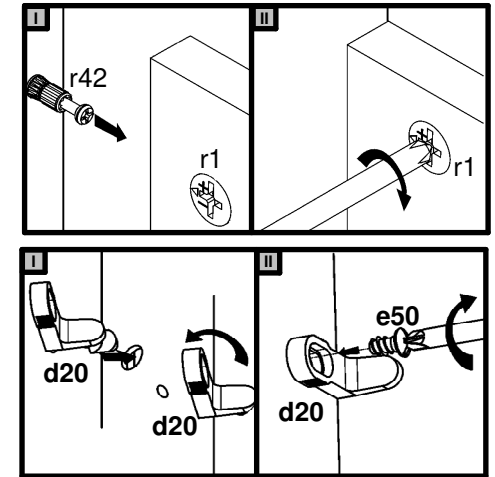
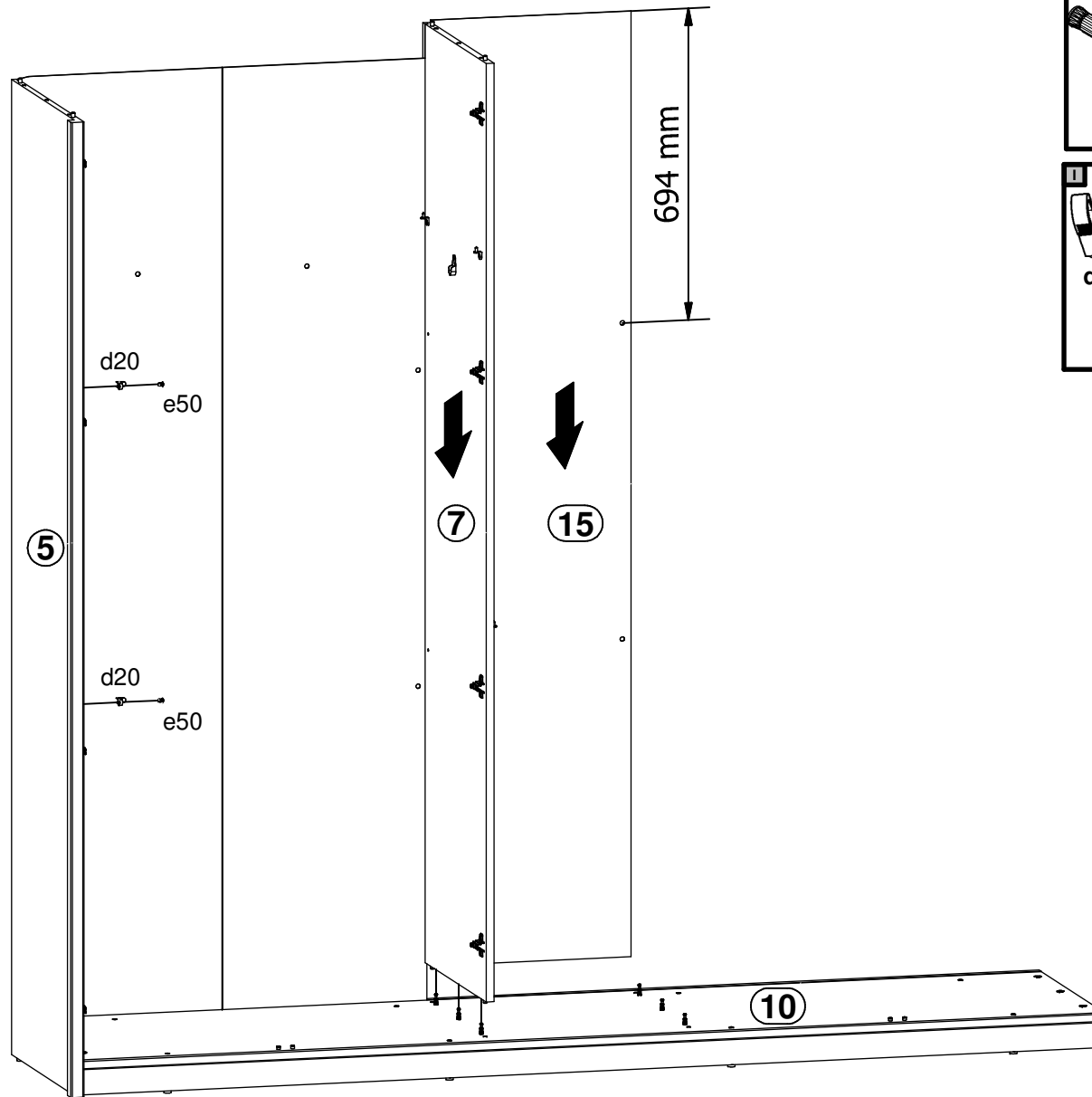

8 

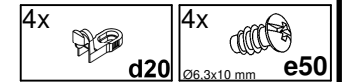
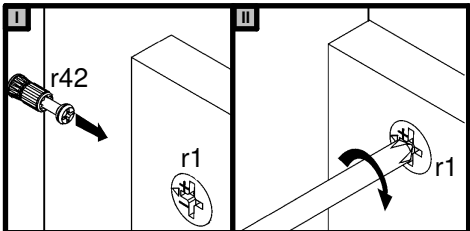
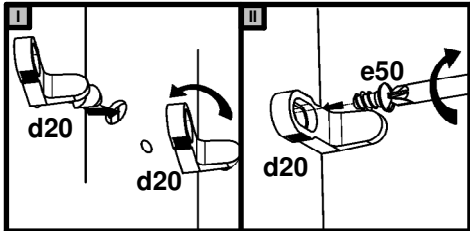
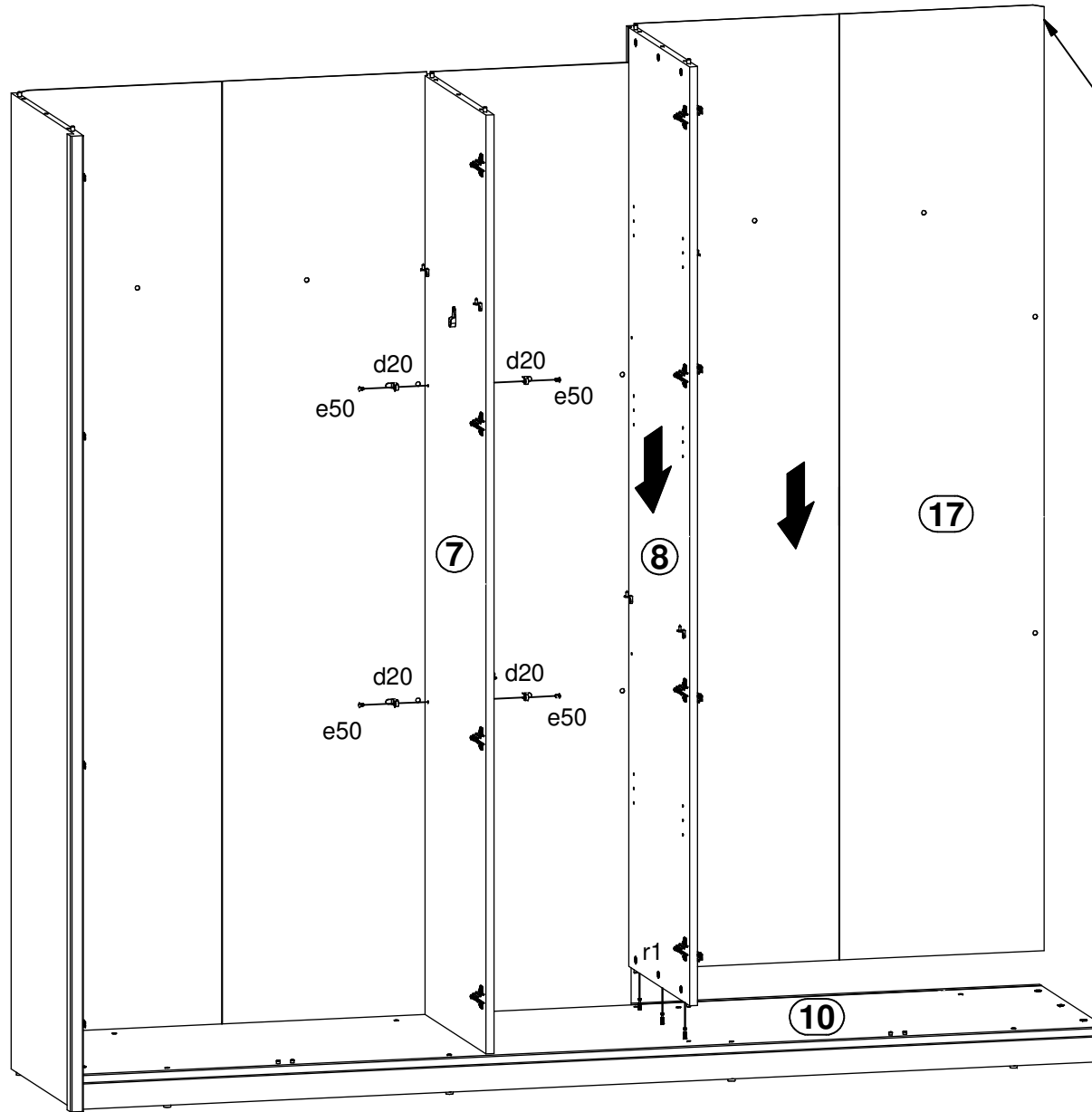

9 

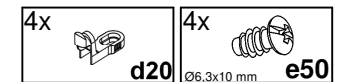
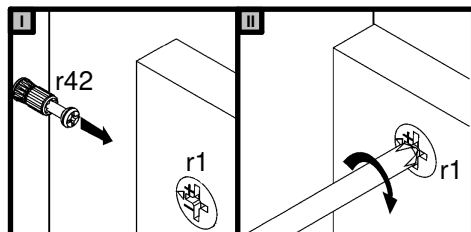
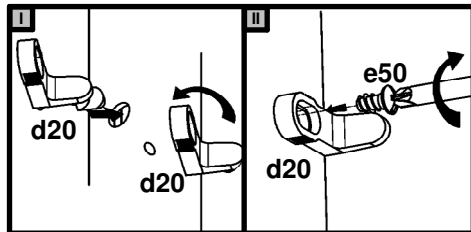
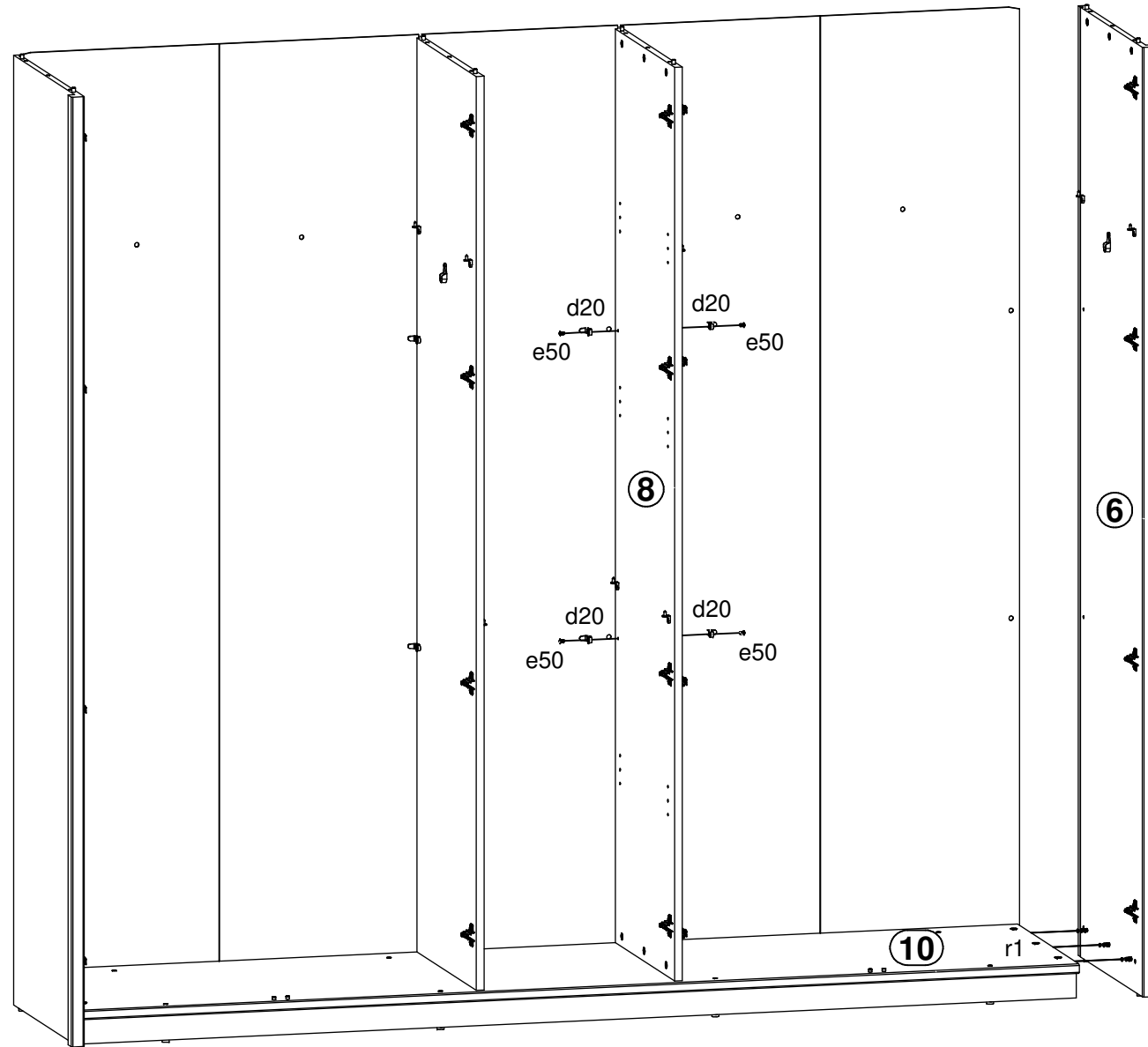

10 

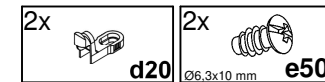
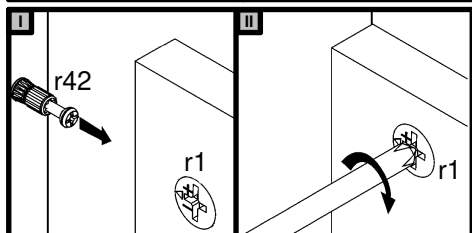
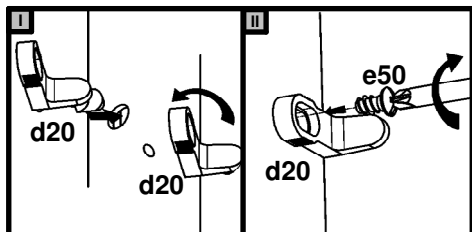
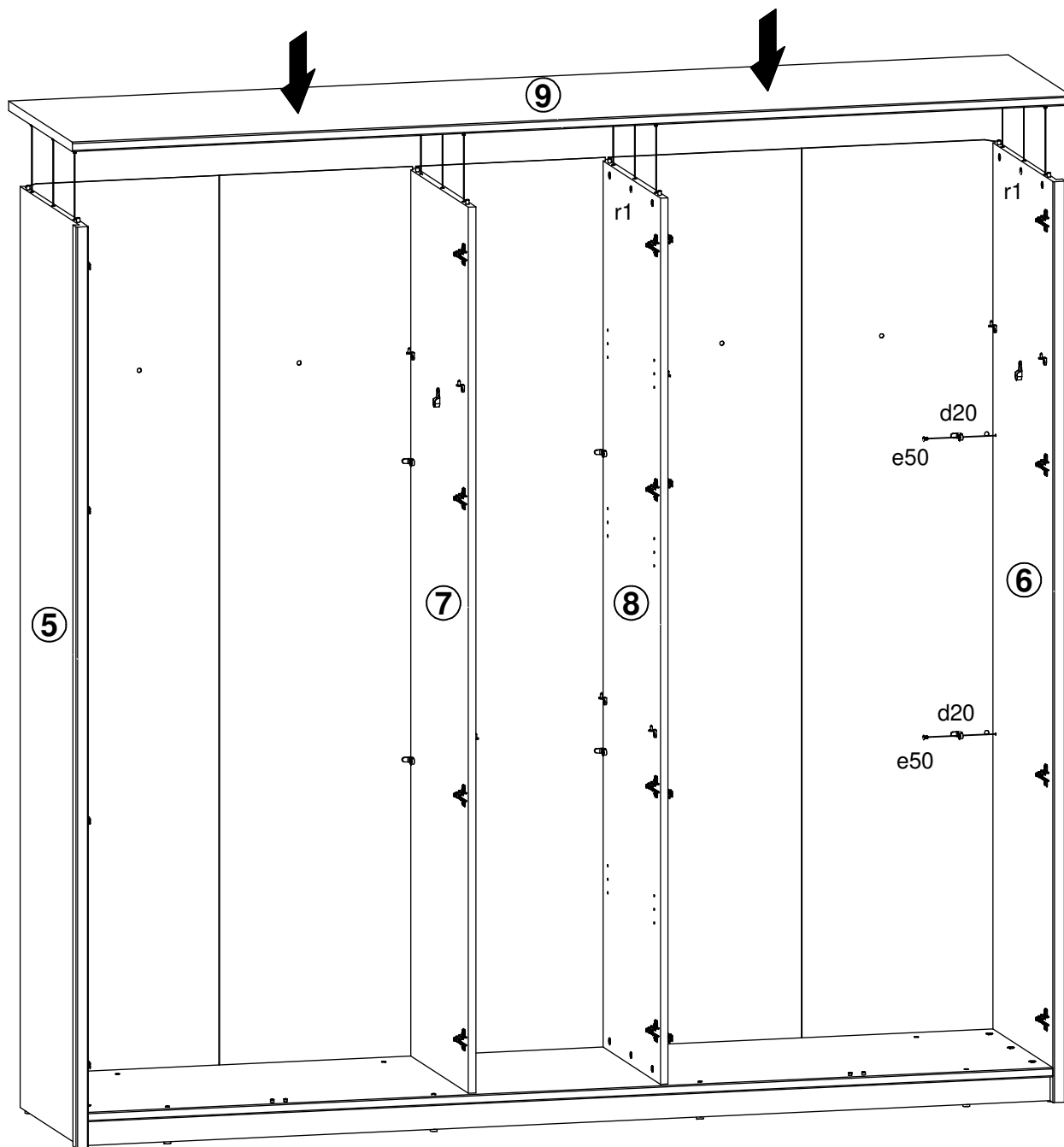
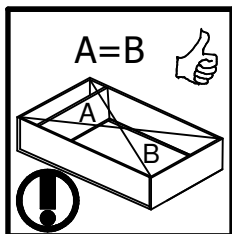



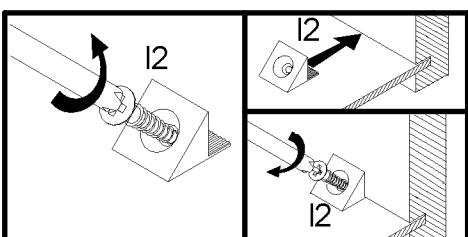
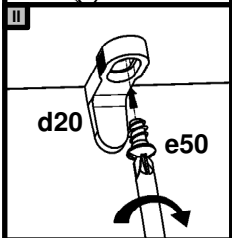
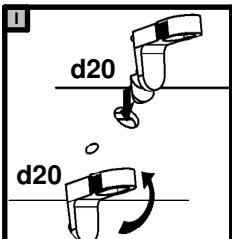
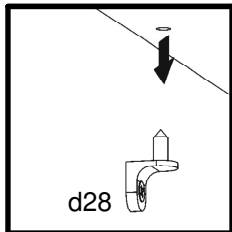
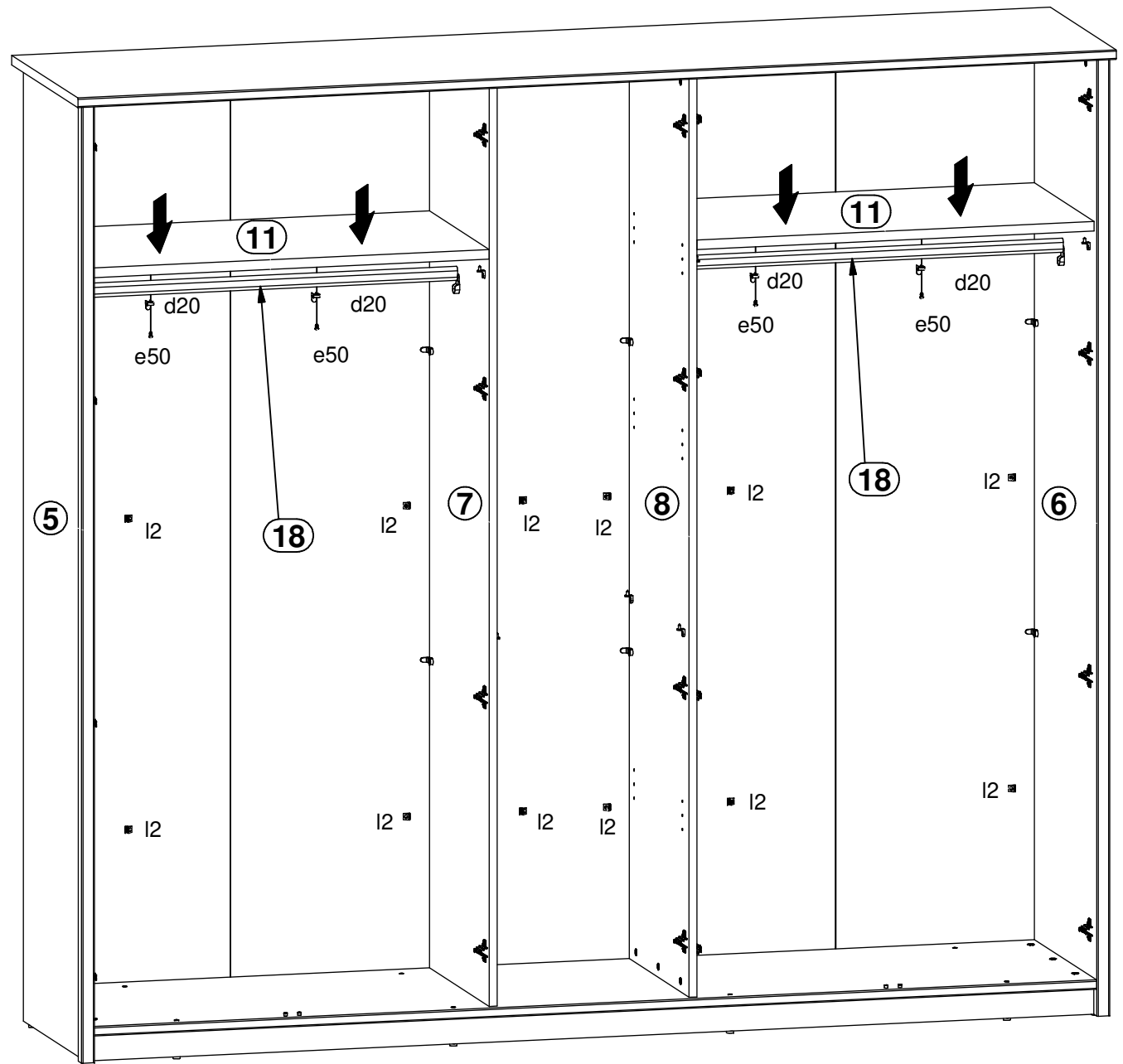



11

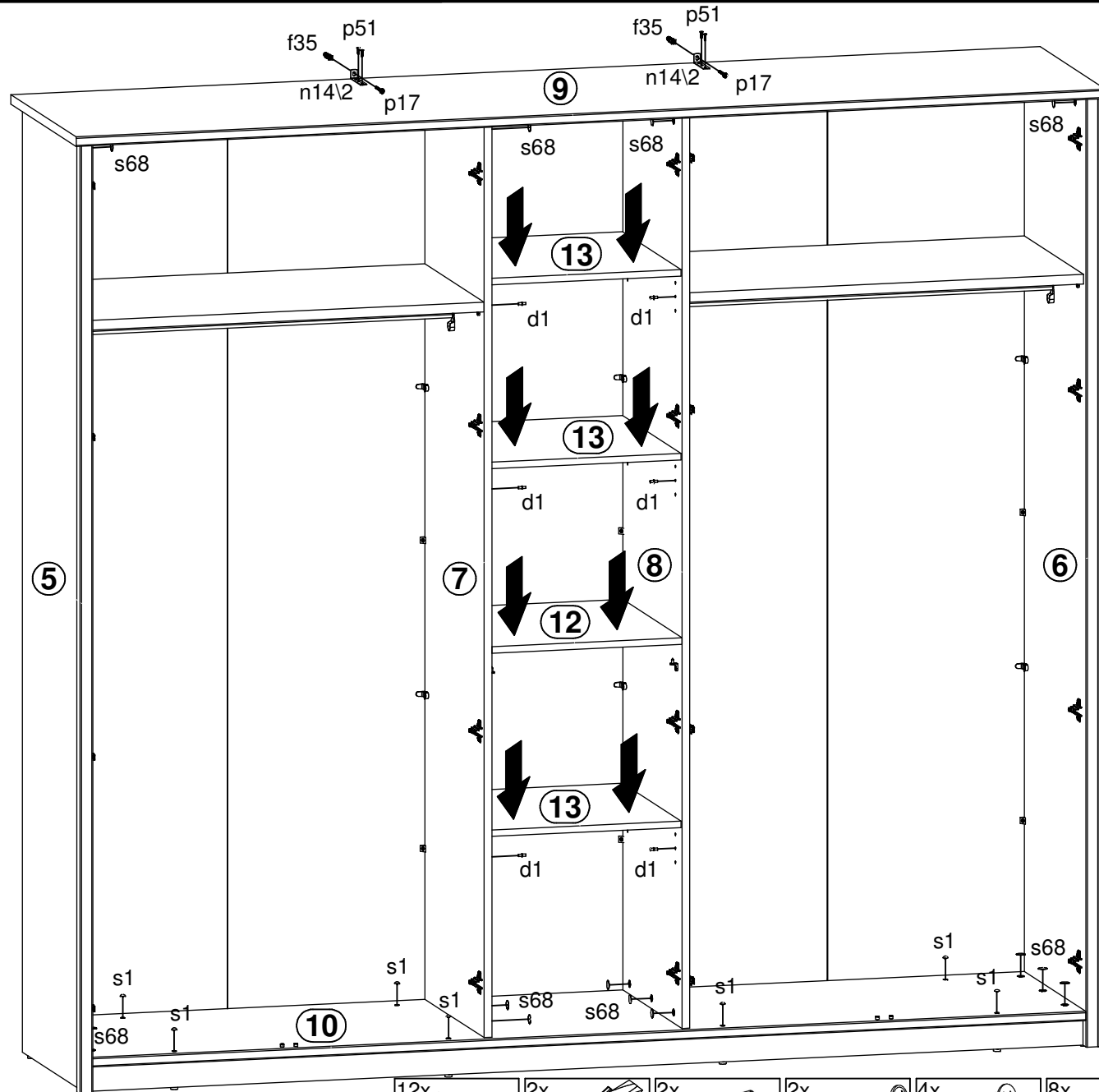
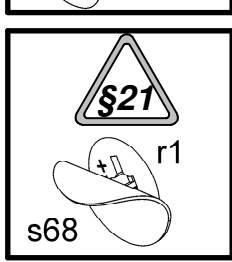
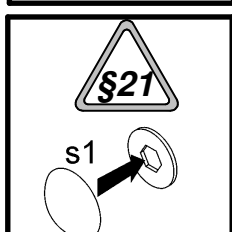
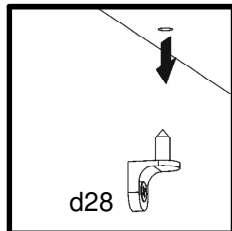
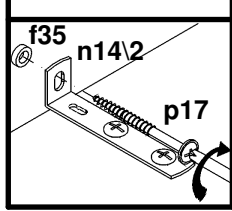
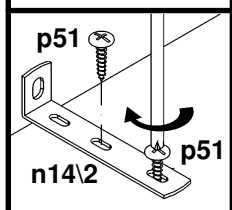
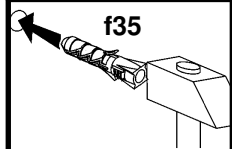
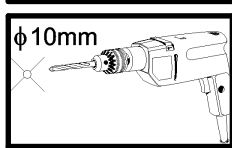
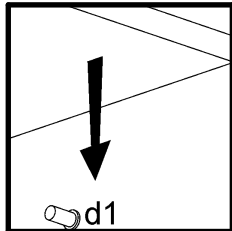
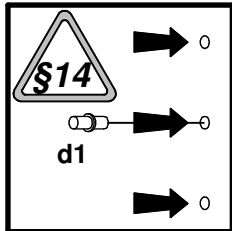

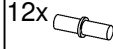
- 4x d20
- 4x e50
- 12x I2

12 

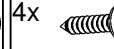

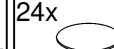
- 12x  $\varnothing 5 \times 17 \text{ mm}$ d1
- 2x  $\varnothing 10 \times 50 \text{ mm}$ f35
- 2x  $88 \times 21 \times 15 / 1,5$ n14/2
- 2x  $\varnothing 5 \times 60 \text{ mm}$ p17
- 4x  $\varnothing 3,5 \times 15 \text{ mm}$ p51
- 8x  s1
- 24x  $\varnothing 20 \text{ mm}$ s68

13

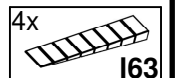
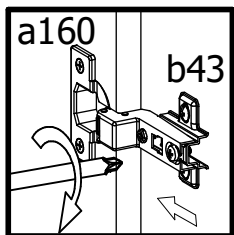
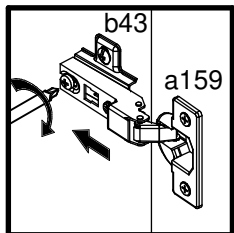
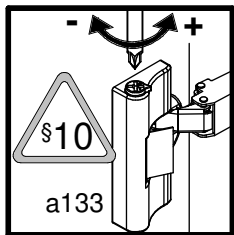
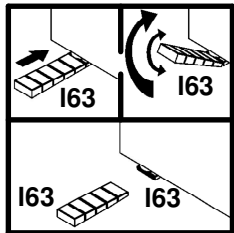
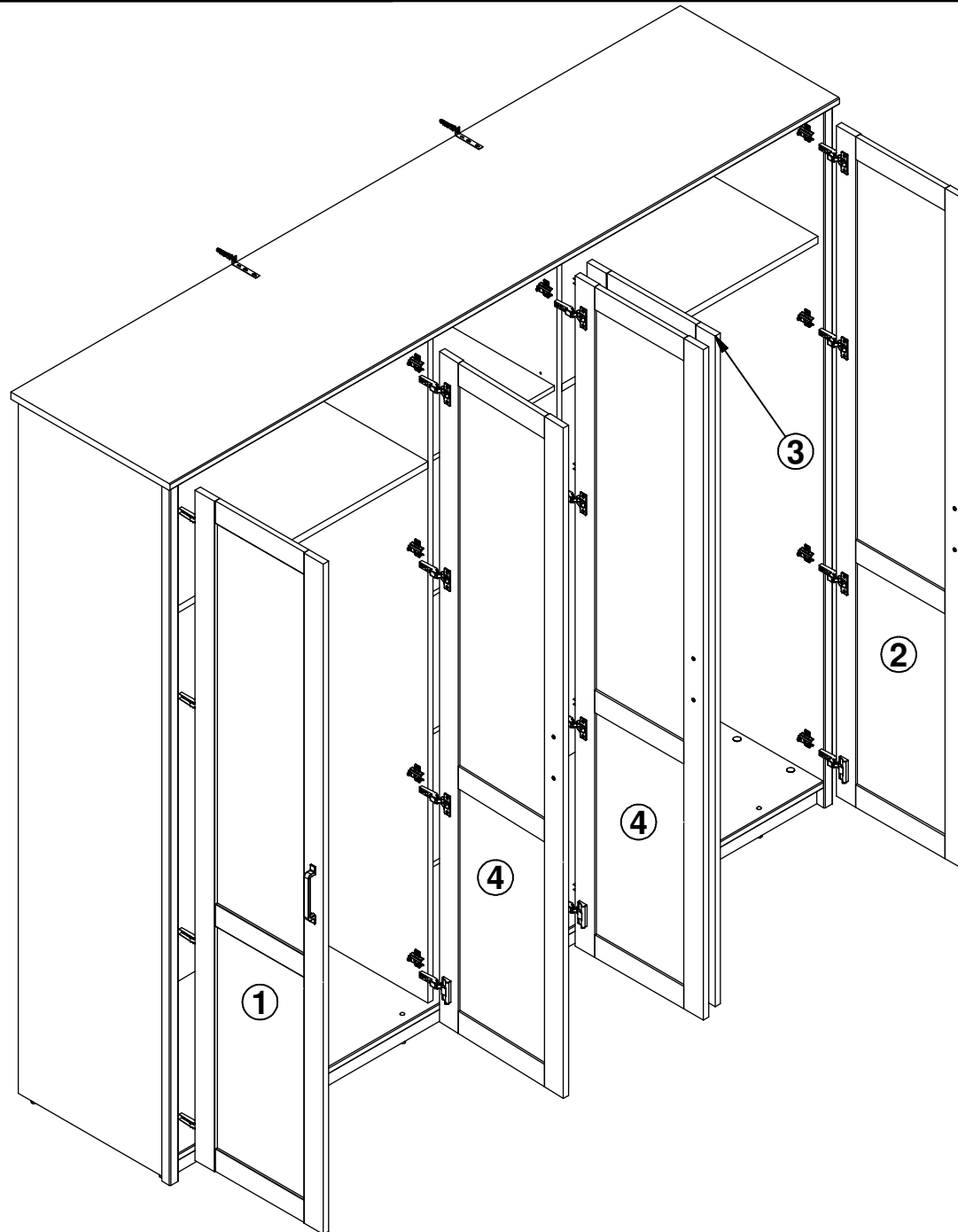

14

