

A	B	C (mm)			D
1	S442-1028	1950	600	15	1/9
2	S442-1029	1950	571	15	3/9
3	S442-1030	1854	555	15	1/9
4	S442-3015	1800	555	15	4/9
5	S442-3016	1800	571	15	4/9
6	S442-3017	657	555	15	2/9
7	S442-3018	656	555	15	2/9
8	S442-3019	1128	555	15	4/9
9	S442-4039	1800	66	15	4/9
10	S442-4040	1800	66	15	4/9
11	S442-9310	1879	677	2,5	3/9
12	S442-9311	1879	1149	2,5	3/9
13	dr-1124	1124	30	15	4/9
14	dr-652	652	30	15	2/9

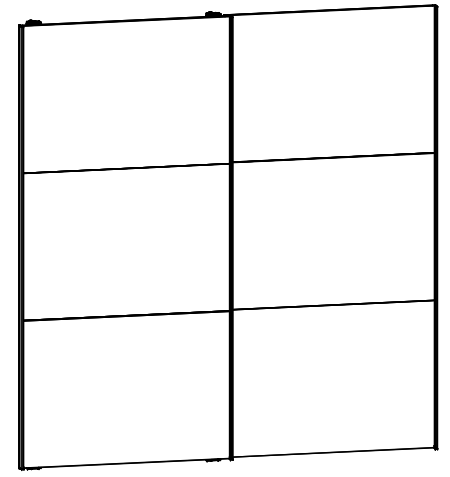

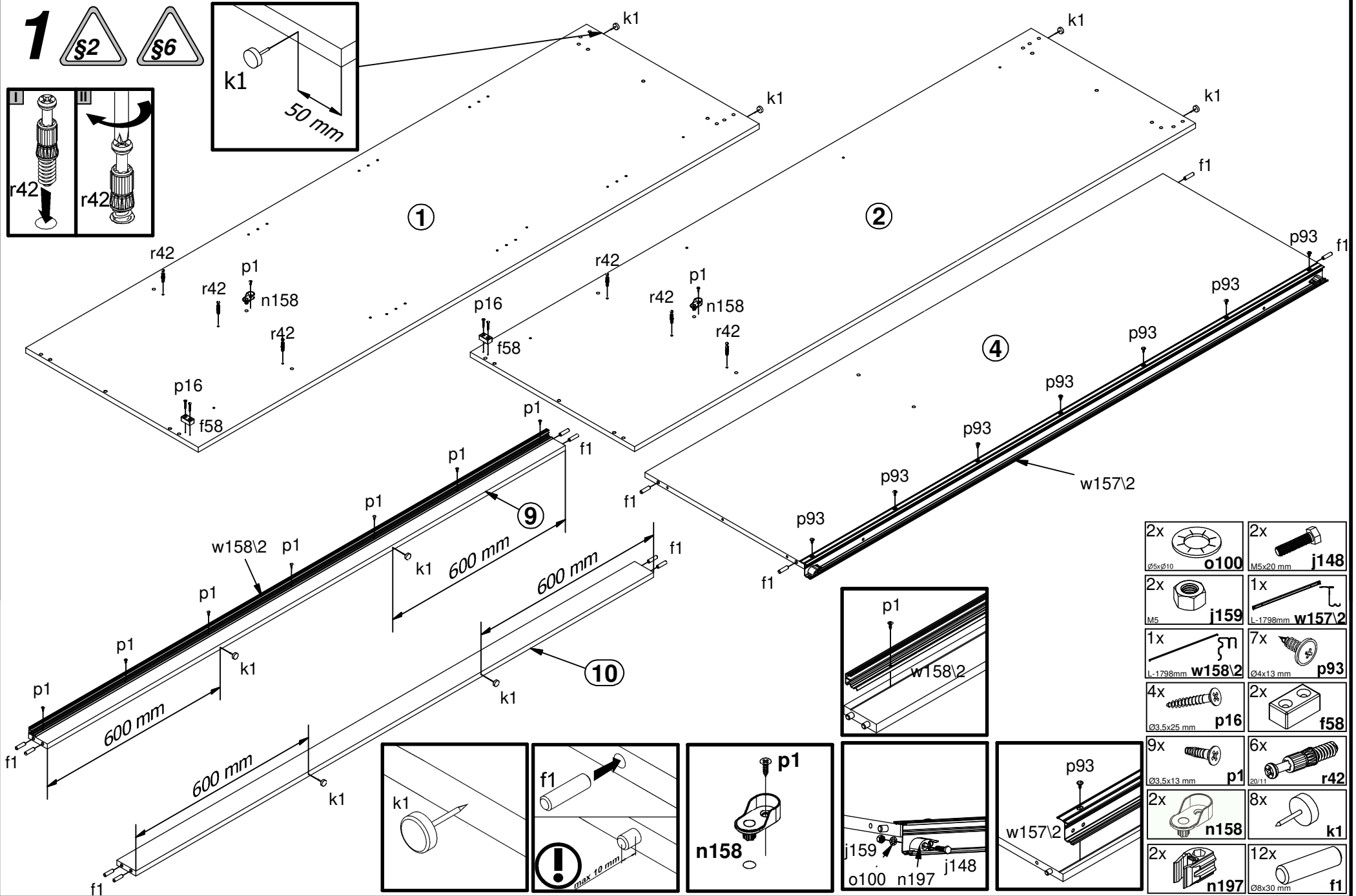

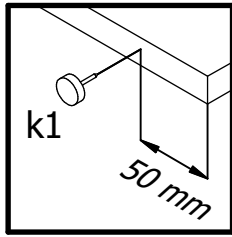
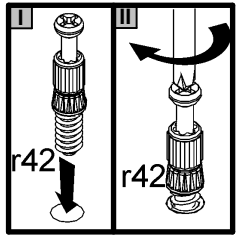

12x Ø5x17 mm d1	22x Ø7x50 mm e1	24x Ø5,5x13 mm e13	24x Ø8x30 mm f1	cm 0 1 2 3 4 5 6 7 8 9 10						2x Ø10x50 mm f35	2x f58	2x Ø8x50 mm f6	D 4/9
2x M5x20 mm j148	2x M5 j159	8x k1	10x 22x9,5x20,7 mm n108	8x 90x50x1,5 mm n148	2x 86x21x15x1,5 n142	4x n158	2x n194	2x n195	1x n196	2x n197	2x n198	2x n199	
3x L=1900 mm n140/8	2x Ø5xØ10 o100	12x Ø3,5x13 mm p1	4x Ø3,5x25 mm p16	2x Ø5x60 mm p17	50x Ø2,9x16 mm p55	95x Ø4x13 mm p93	12x Ø15x12 mm #16 r1	3x r10	6x 20/11 r42	16x Ø14x0,5 mm s59	12x Ø20mm s68	3x L=1900 mm w136/4	
1x L=1798mm w157/2	1x L=1900mm w159/3	1x L=1798mm w158/2	3x w180/1	1x 4 mm z1									

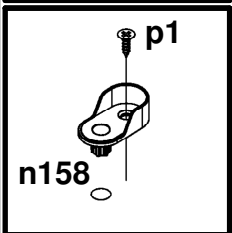
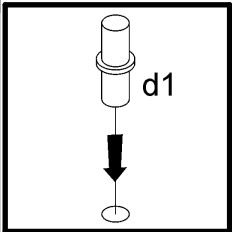
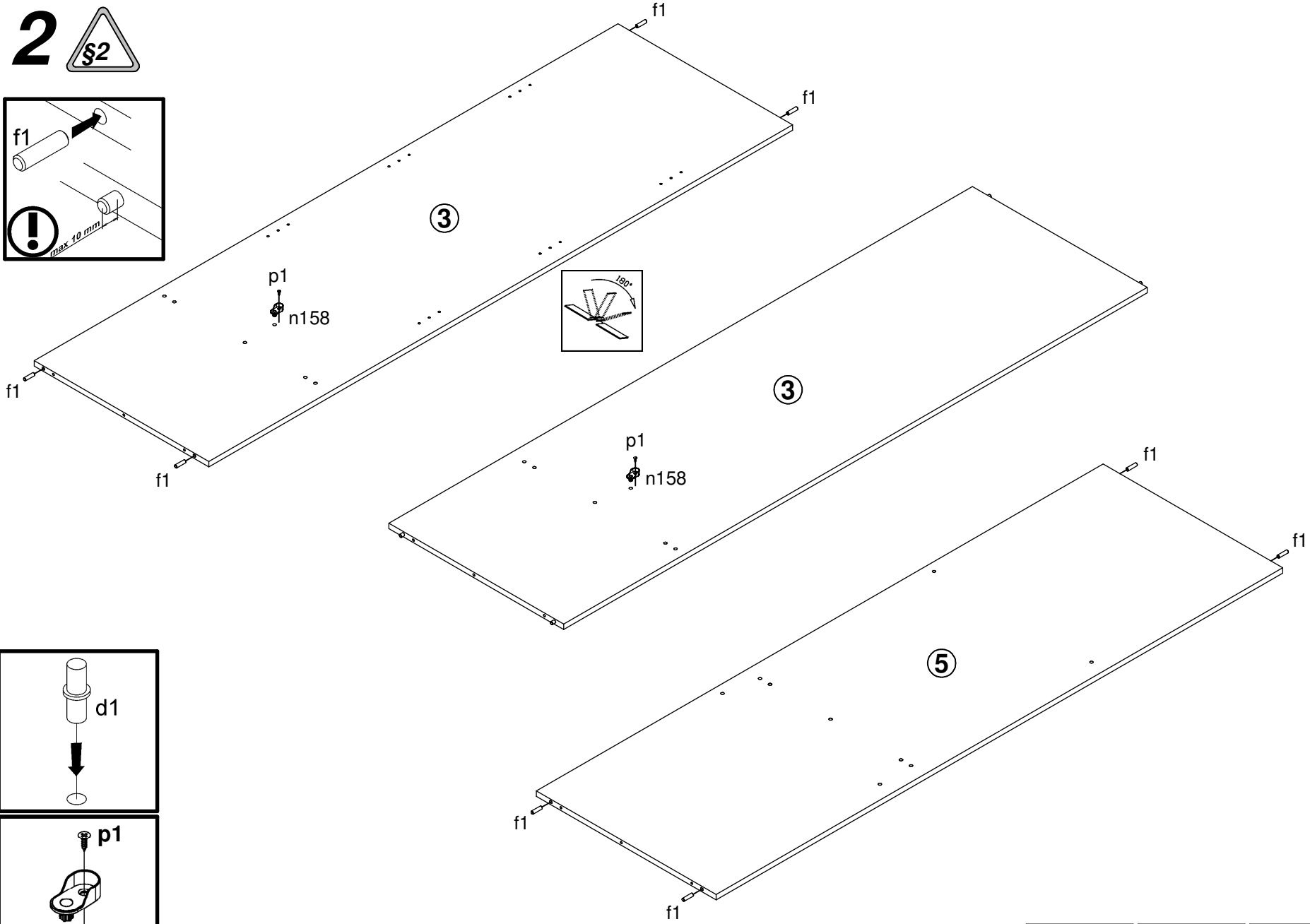
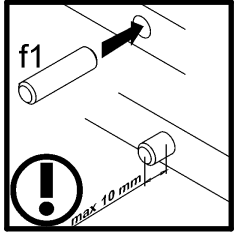

2x o100 ø5xø10	2x j148 M5x20 mm
2x j159 M5	1x w157/2 L-1798mm
1x w158/2 L-1798mm	7x p93 Ø4x13 mm
4x p16 Ø3.5x25 mm	2x f58
9x p1 Ø3.5x13 mm	6x r42 ø11
2x n158	8x k1
2x n197	12x f1 Ø8x30 mm

2 



2x  p1 Ø3,5x13 mm	2x  n158 Ø8x30 mm	8x  f1 Ø8x30 mm	6x  d1 Ø5x17 mm
---	---	---	---

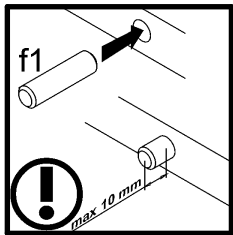
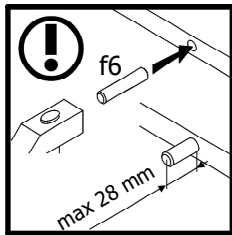
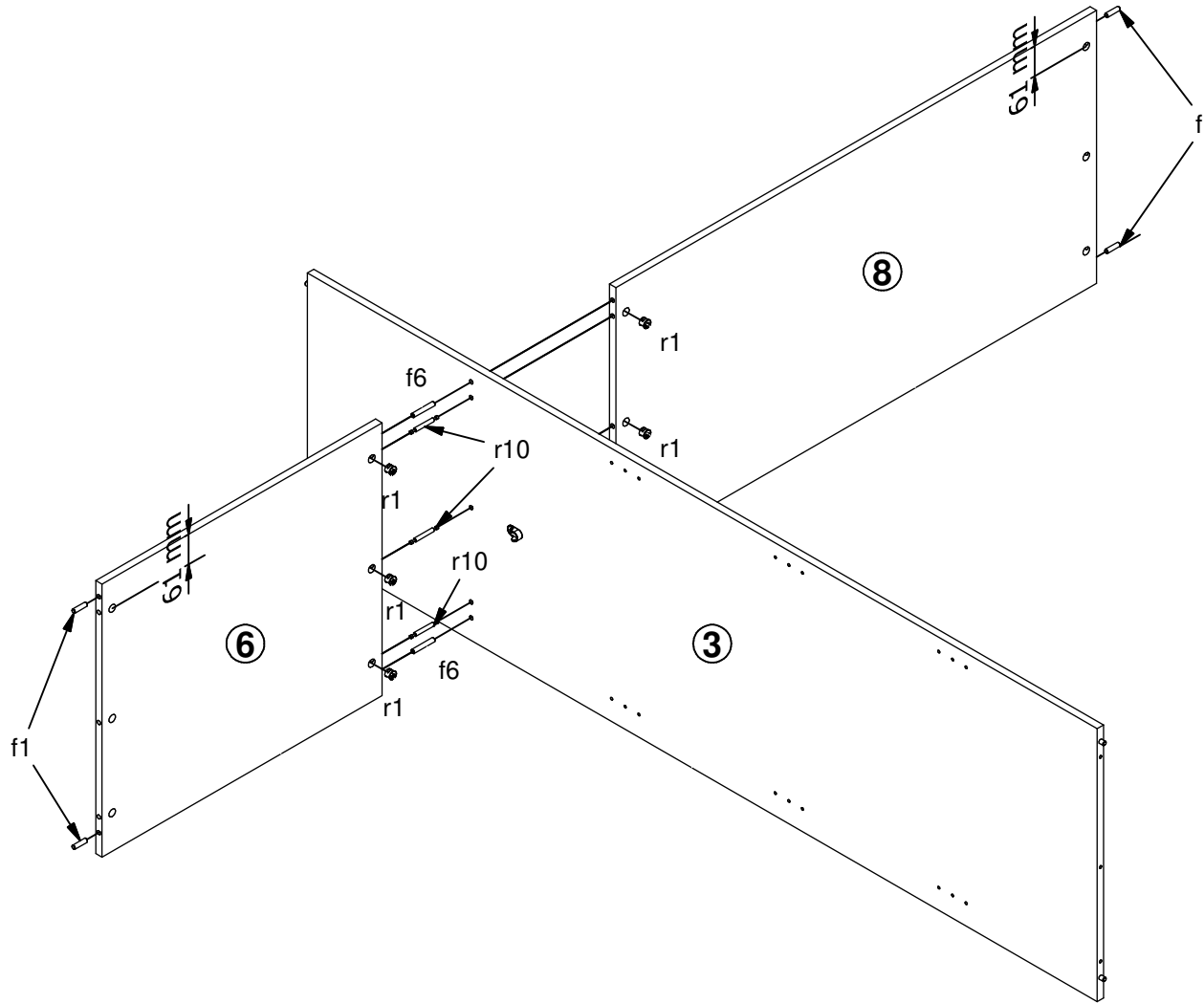
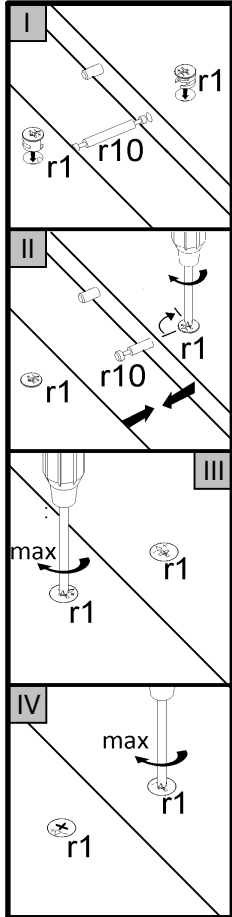

3 

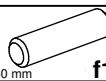
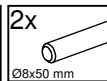
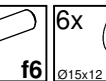
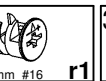

- | | | | |
|---|---|--|--|
| 4x  f1
Ø8x30 mm | 2x  f6
Ø8x50 mm | 6x  r1
Ø15x12 mm #16 | 3x  r10 |
|---|---|--|--|

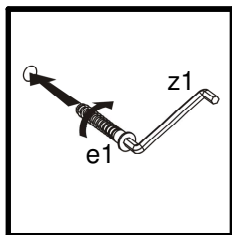
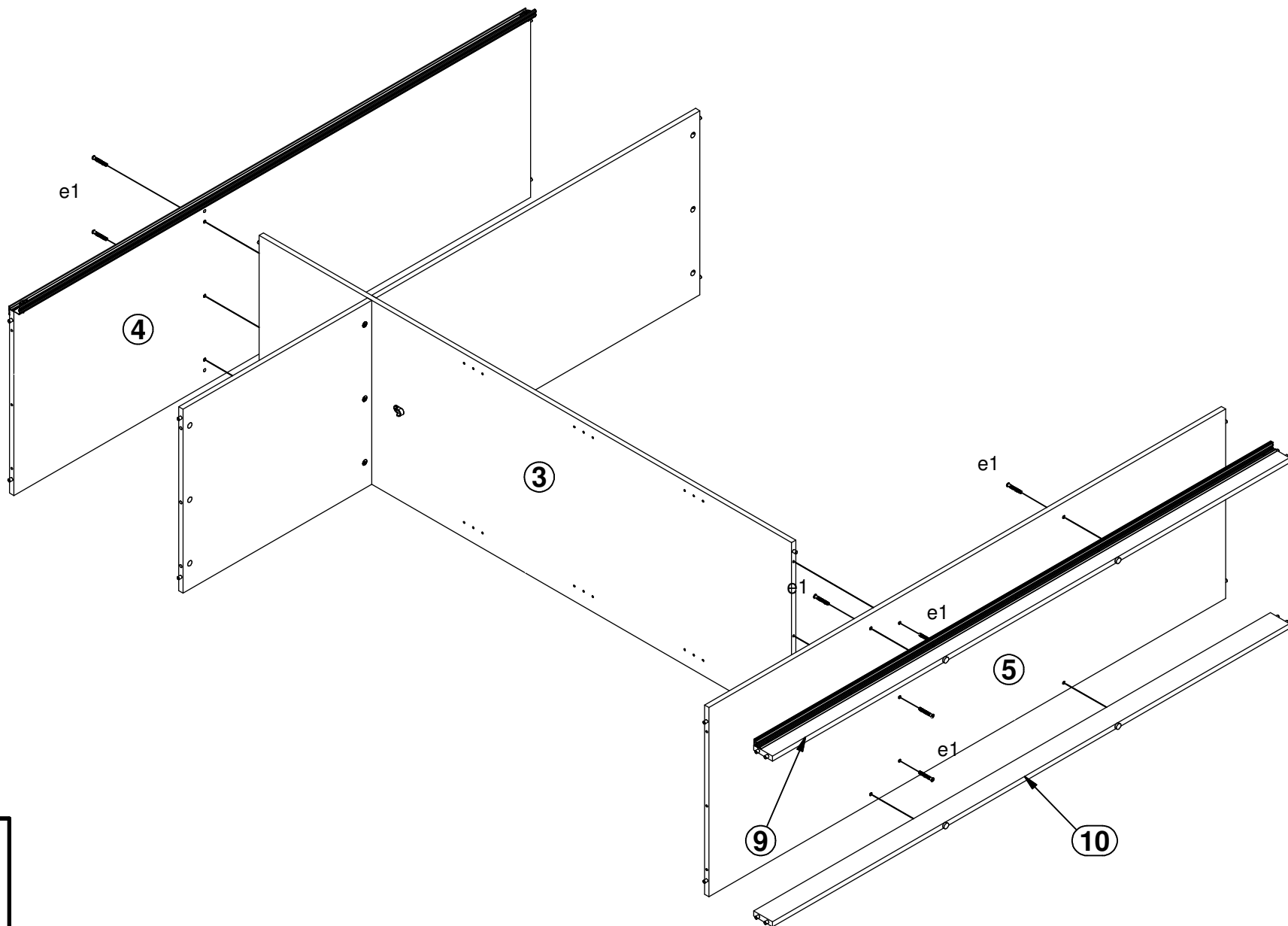

4 

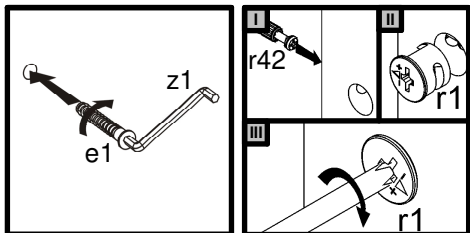
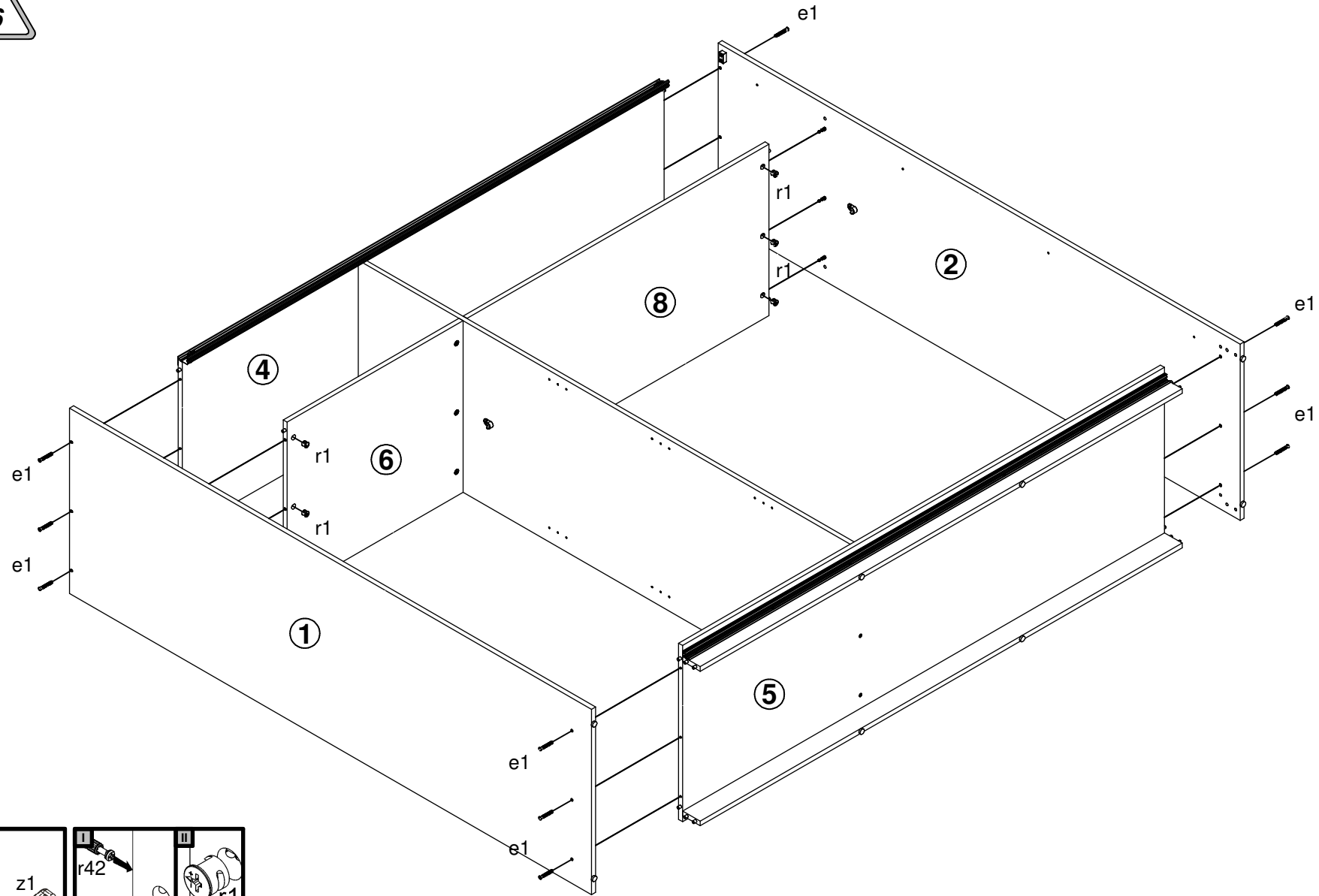

10x  Ø7x50 mm	1x  4 mm	1x  z1
--	---	---

5 



- | | | |
|---|---|--|
| 1x
4 mm

z1 | 6x

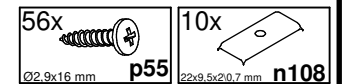
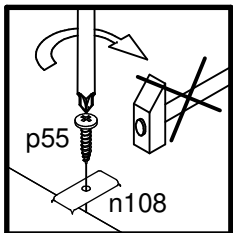
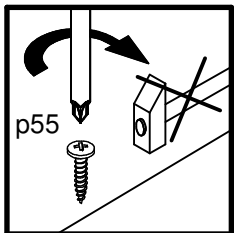
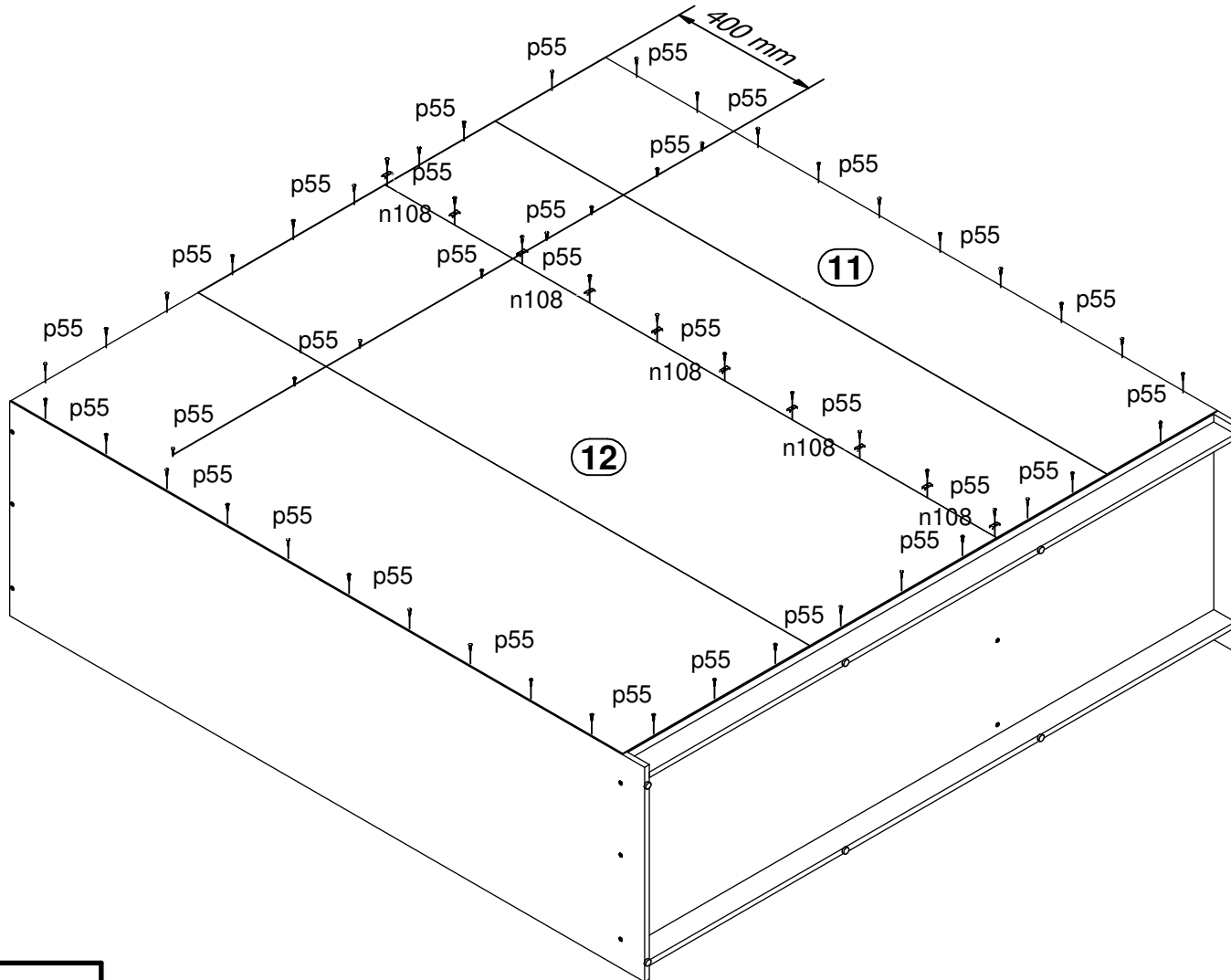
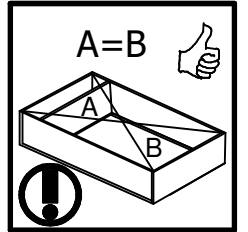
r1 | 12x

e1 |
|---|---|--|

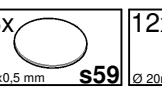
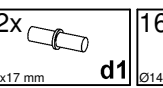
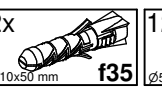
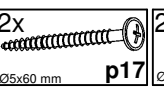
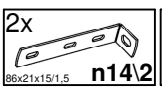
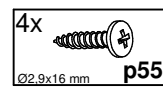
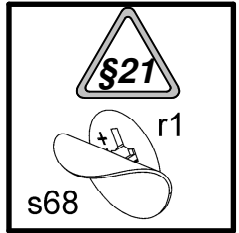
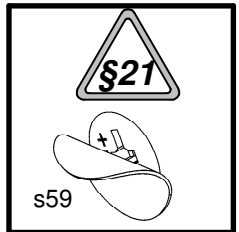
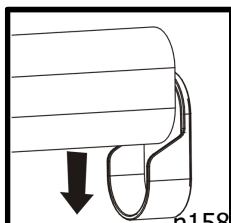
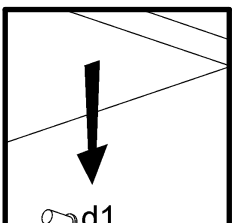
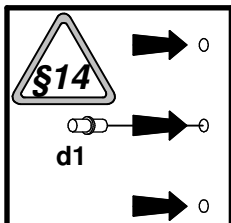
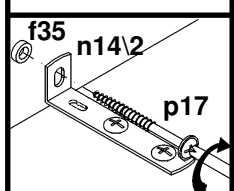
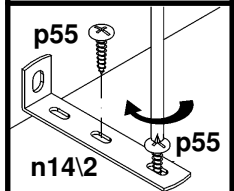
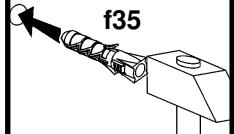
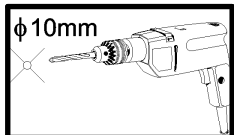
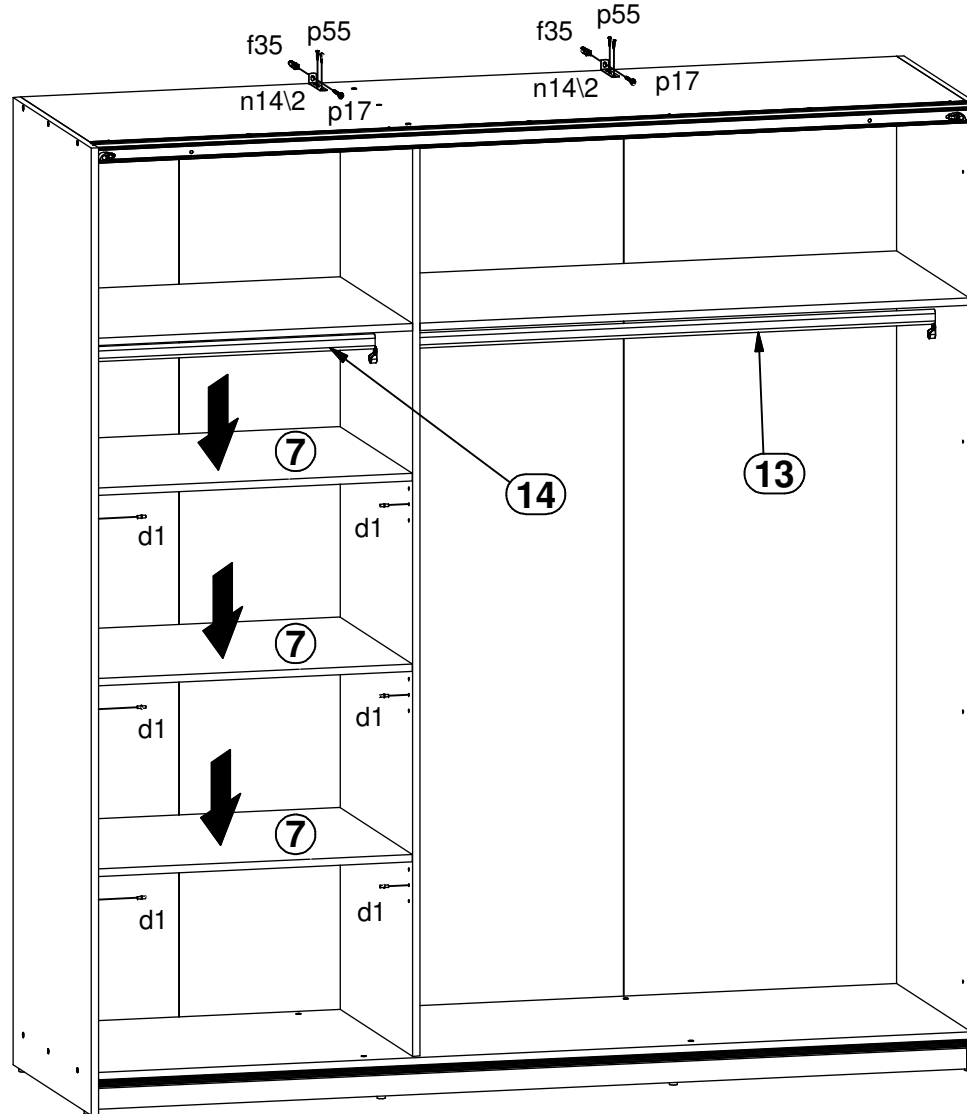
6 



7 



8

