

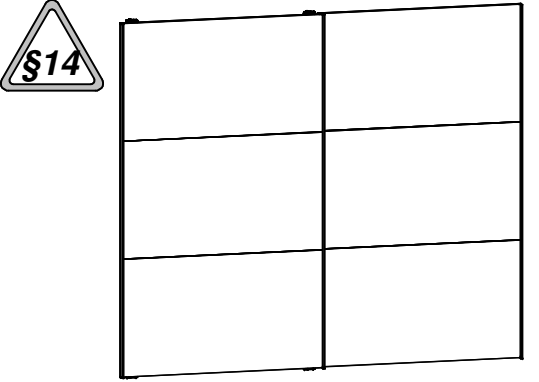

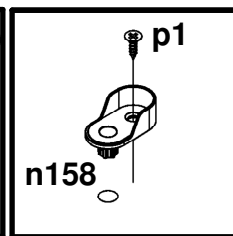

A	B	C (mm)			D
1	S442-1028	1950	600	15	1/10
2	S442-1030	1854	555	15	1/10
3	S442-1031	1950	571	15	4/10
4	S442-1032	1854	555	15	4/10
5	S442-3017	657	555	15	2/10,3/10
6	S442-3018	656	555	15	2/10,3/10
7	S442-3020	2170	555	15	5/10
8	S442-3021	2170	571	15	5/10
9	S442-3022	826	555	15	5/10
10	S442-4041	2170	66	15	5/10
11	S442-4042	2170	66	15	5/10
12	S442-9310	1879	677	2,5	4/10
13	S442-9312	1879	841	2,5	4/10
14	dr-652	652	30	15	2/10,3/10
15	dr-822	822	30	15	5/10

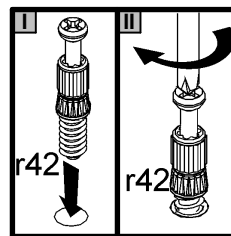
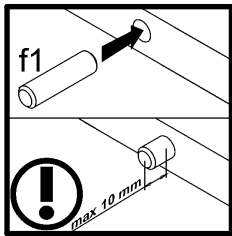
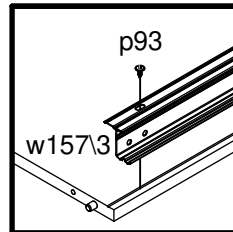
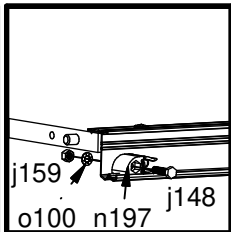
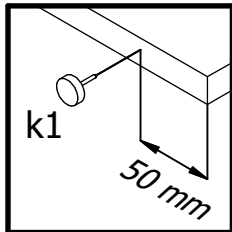
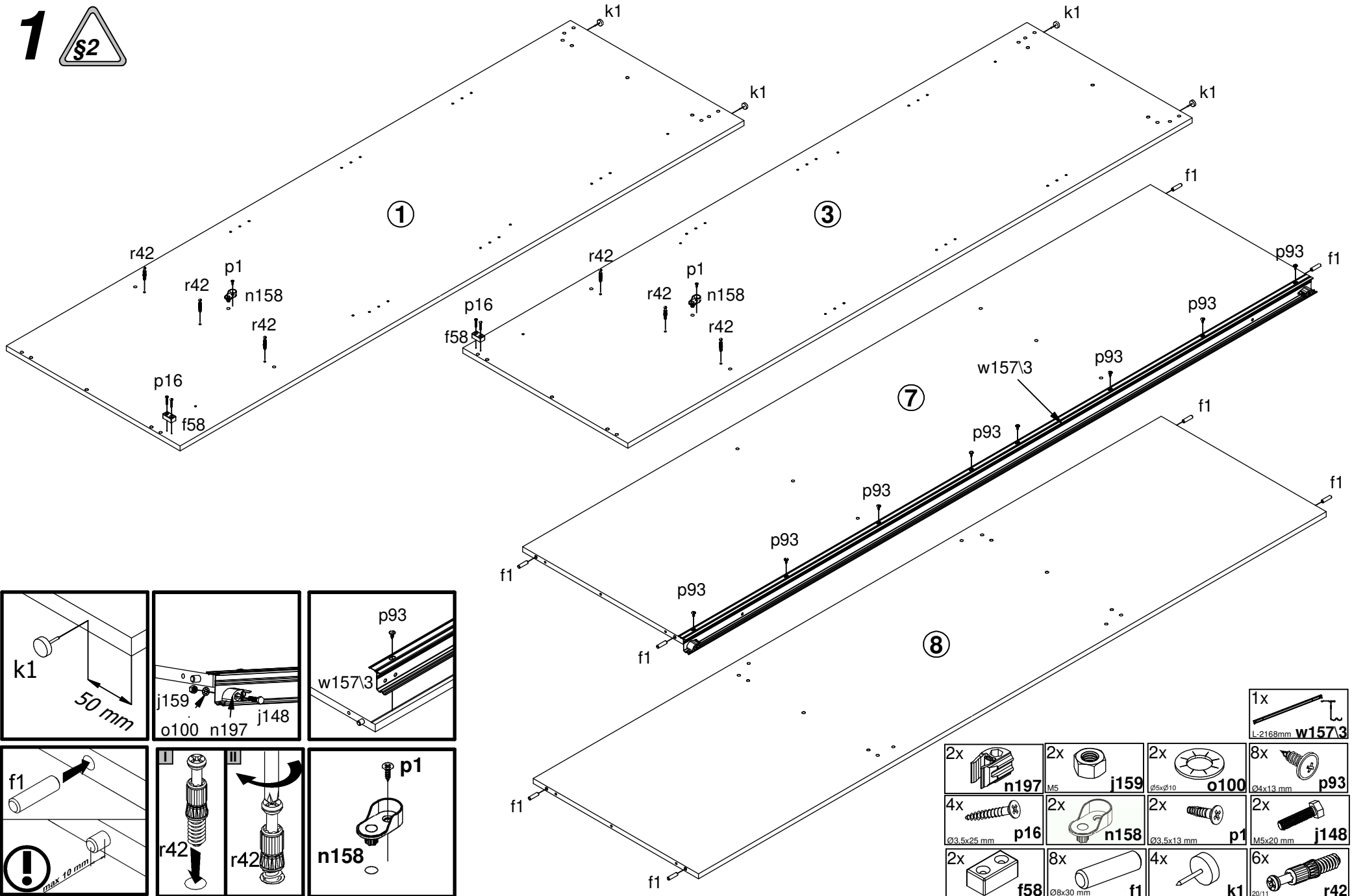

24x Ø5x17 mm d1	28x Ø7x50 mm e1	24x Ø5,5x13 mm e13	28x Ø8x30 mm f1	cm 0 1 2 3 4 5 6 7 8 9 10							2x Ø10x50 mm f35	2x f58	4x Ø8x50 mm f6	D 5/10
2x M5x20 mm j148	2x M5 j159	8x k1	20x 22x9,5x20,7 mm n108	8x 90x50x1,5 mm n148	2x 86x21x15/1,5 n142	6x n158	2x n194	2x n195	1x n196	2x n197	2x n198	2x n199		
3x L-1900 mm n140.8	2x Ø5xØ10 o100	15x Ø3,5x13 mm p1	4x Ø3,5x25 mm p16	2x Ø5x60 mm p17	64x Ø2,9x16 mm p55	96x Ø4x13 mm p93	18x Ø15x12 mm #16 r1	6x r10	6x 20/11 r42	16x Ø14x0,5 mm s59	12x Ø 20mm s68	3x L-1900 mm w136.4		
1x L-2168mm w157.3	1x L-2168mm w158.3	3x w180.1	1x L-1900mm w159.3	1x 4 mm z1										

1 



2x  n197	2x  j159	2x  o100	8x  p93
4x  p16	2x  n158	2x  p1	2x  j148
2x  f58	8x  f1	4x  k1	6x  r42

2 

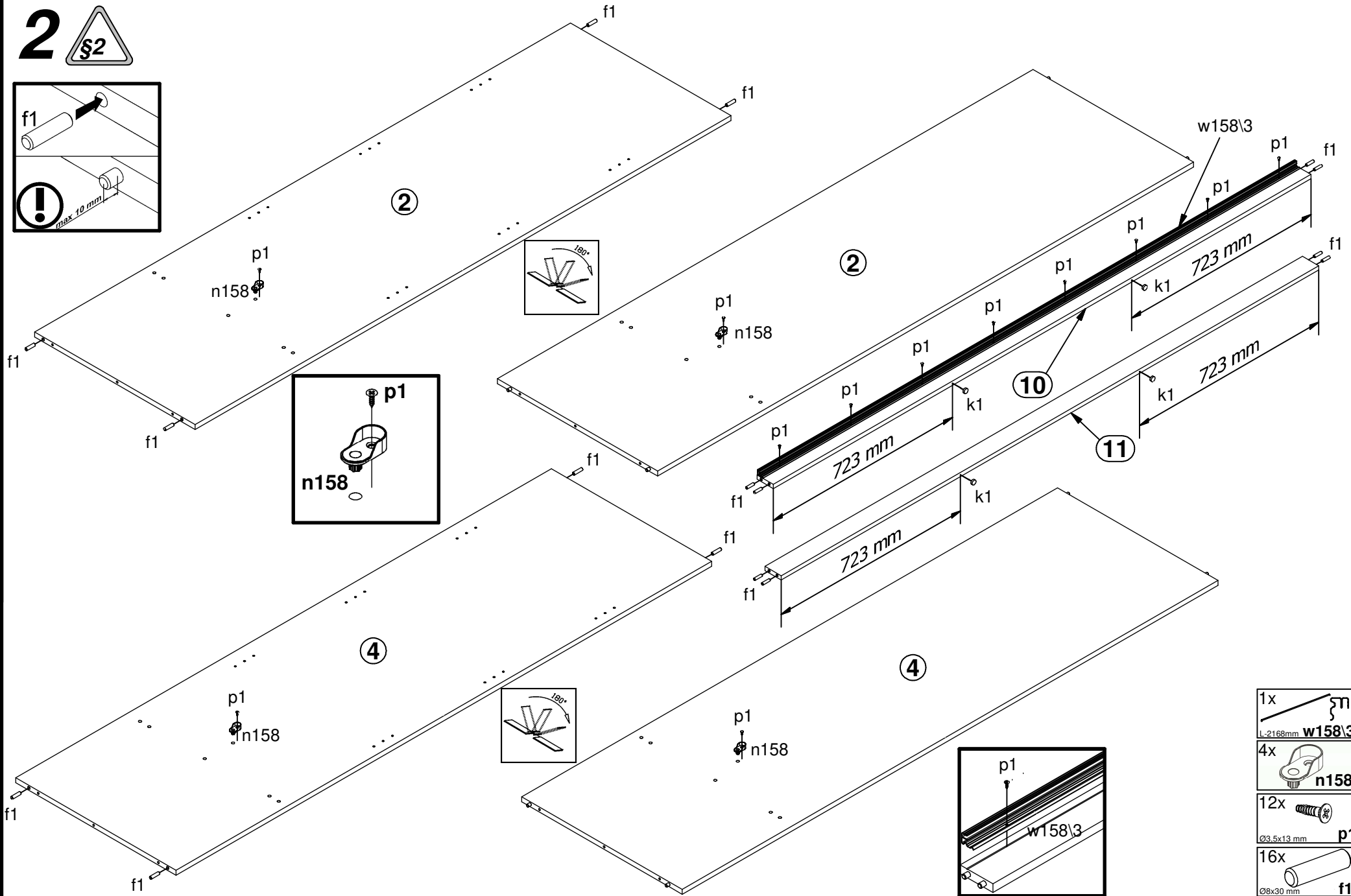
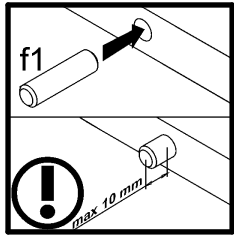

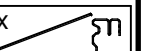
1x 
L-2168mm **w158\3**

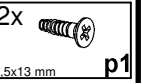

4x 
n158

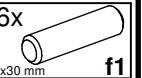
12x 
Ø3,5x13 mm **p1**

16x 
Ø8x30 mm **f1**

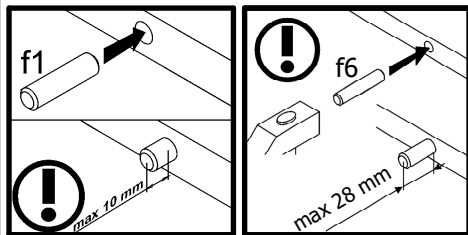
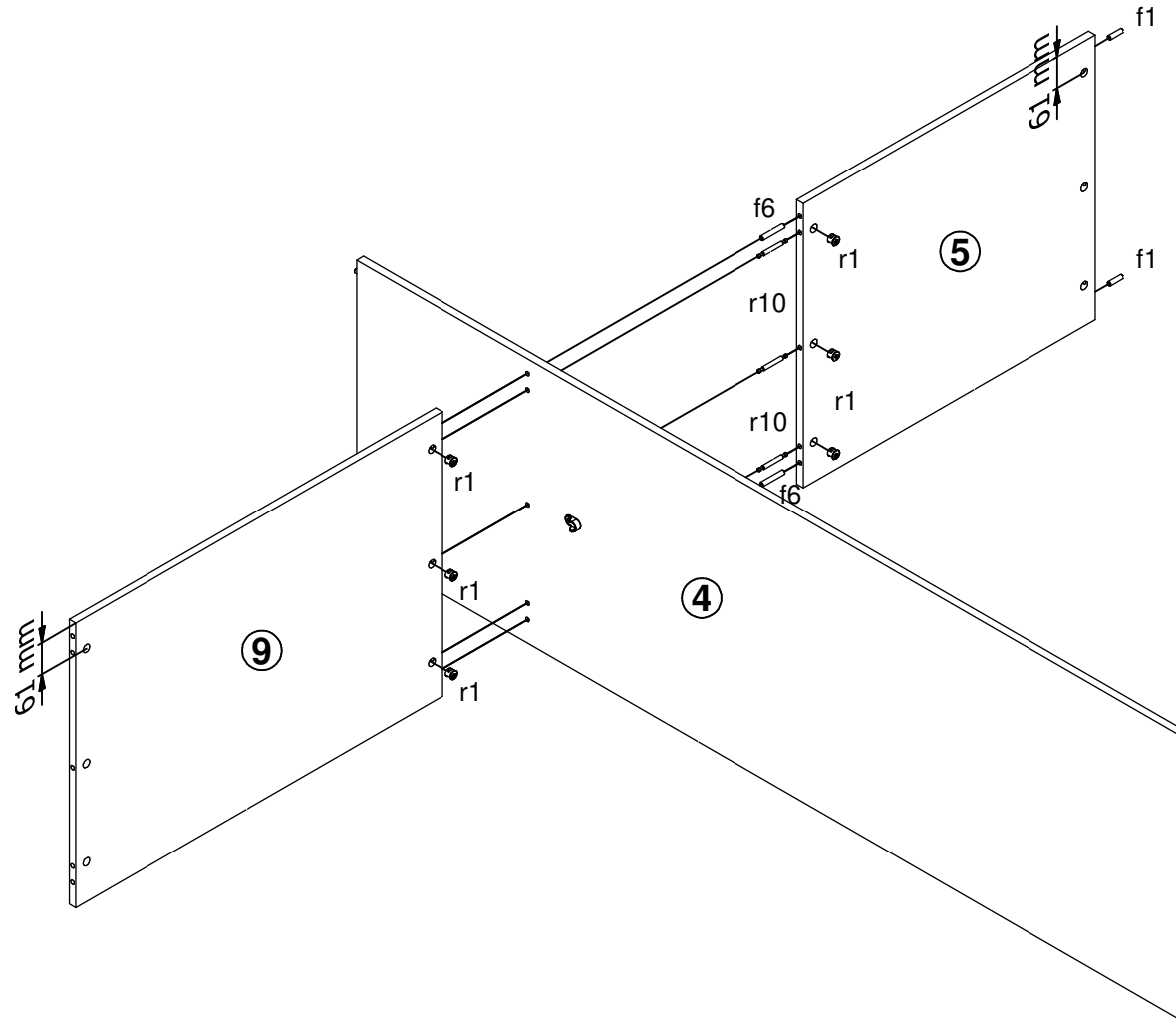
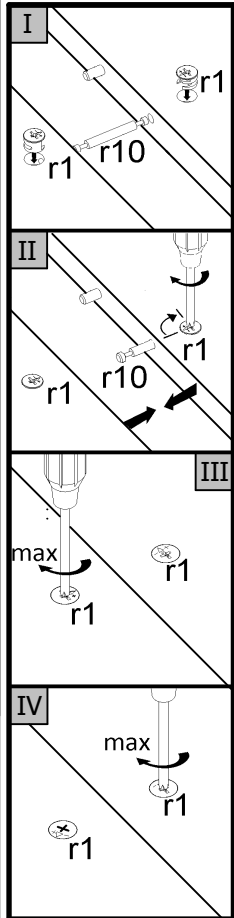

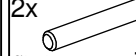
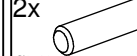

3  

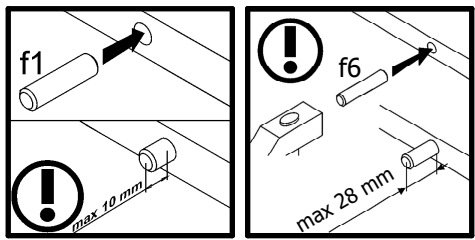
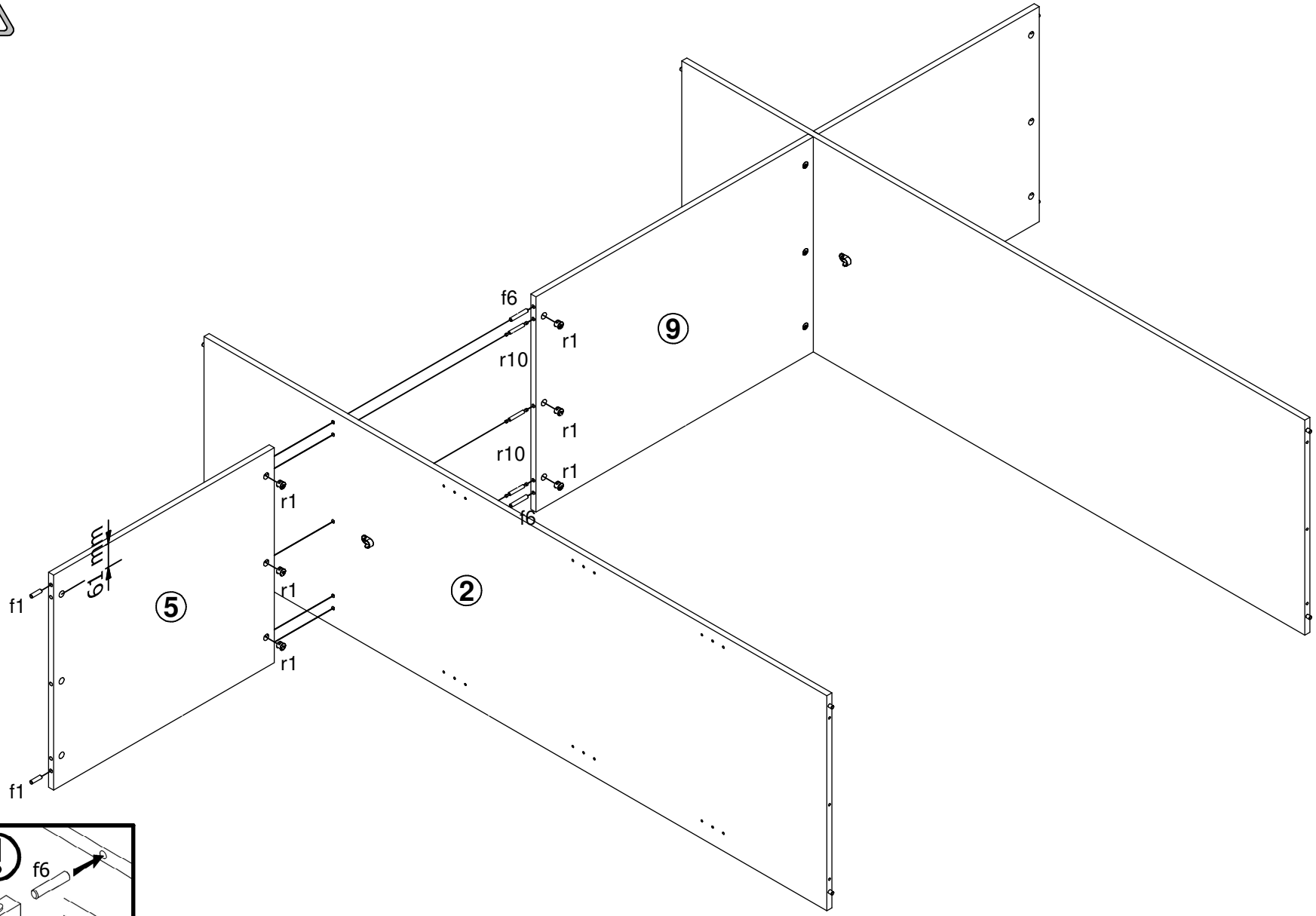
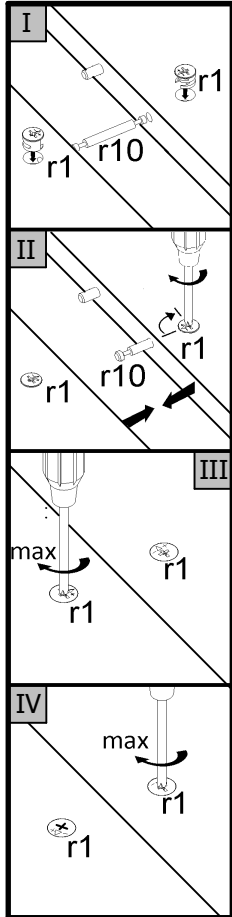

- 3x  r10
- 6x  r1
- 2x  f6
- 2x  f1

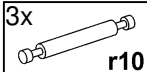

4  

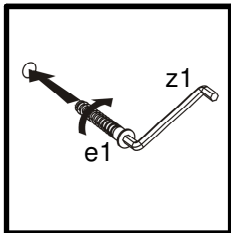
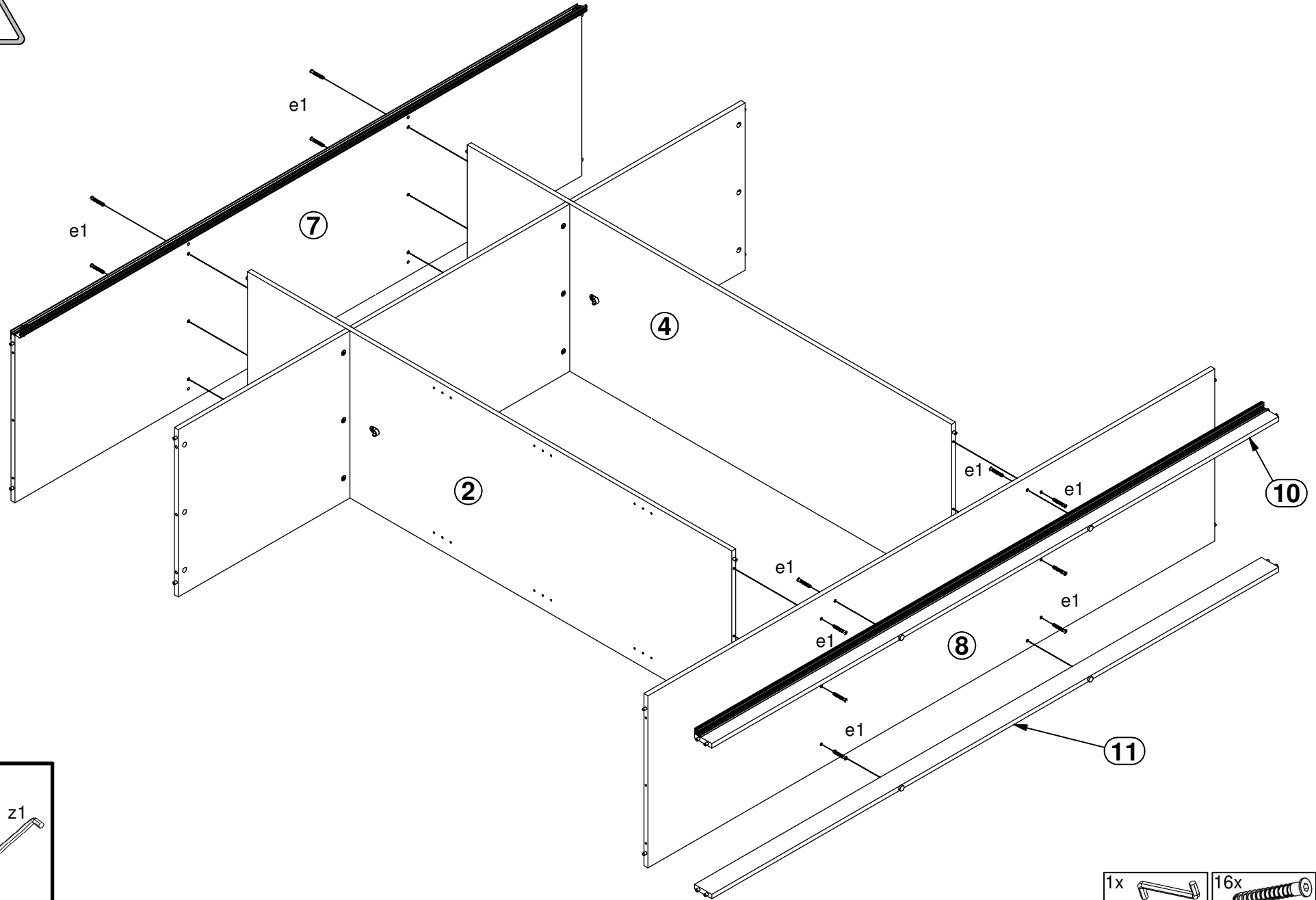

3x  r10	6x  r1	2x  f6	2x  f1
	<small>Ø15x12 mm #16</small>	<small>Ø8x50 mm</small>	<small>Ø8x30 mm</small>

5 



1x 4 mm	 z1	16x	 e1
------------	---	-----	---

6 

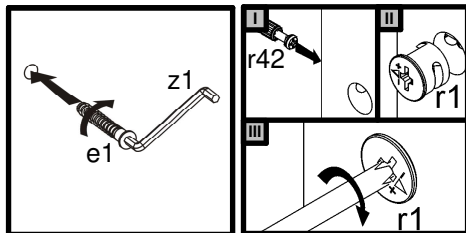
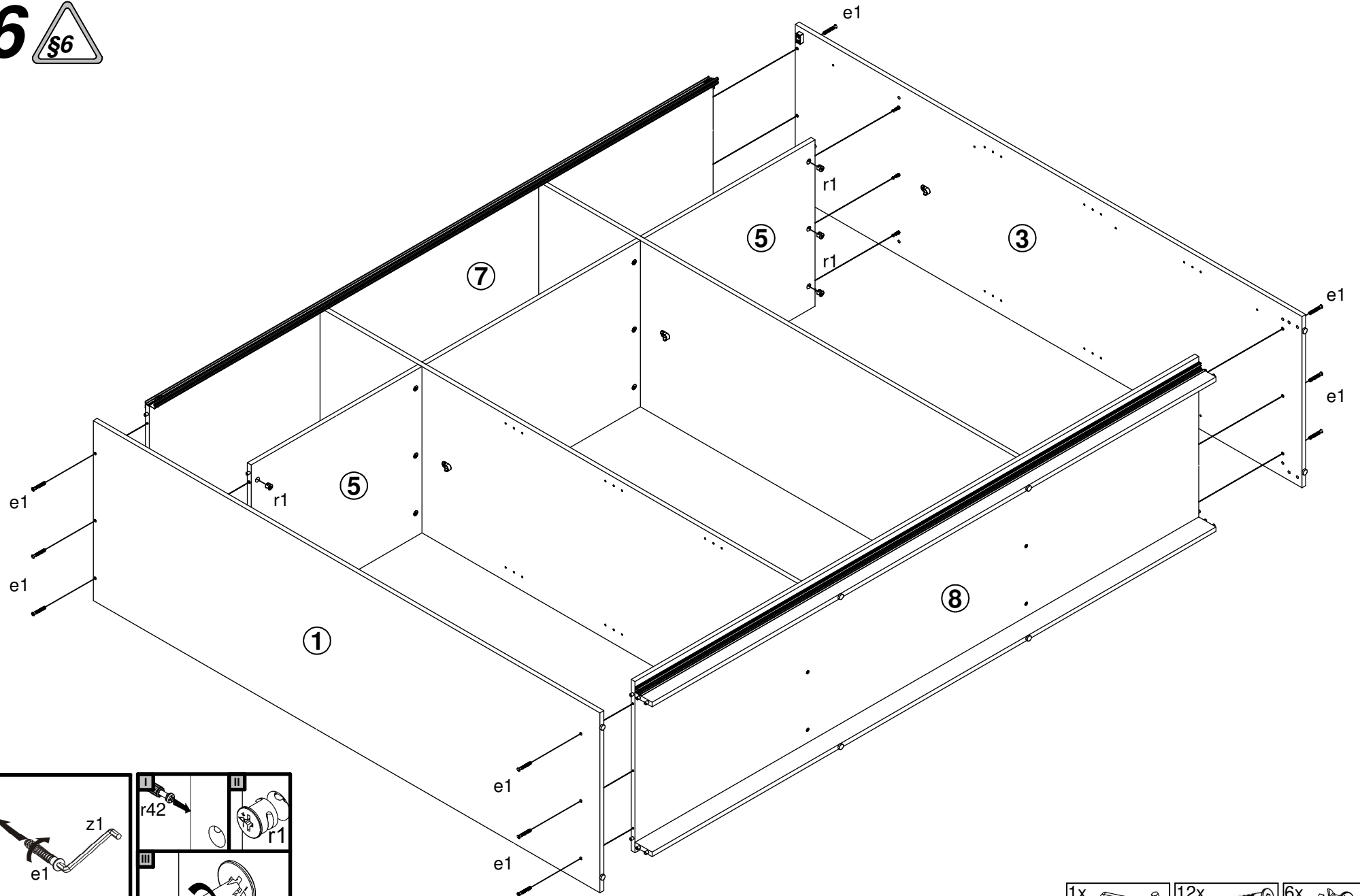

- | | | |
|---|--|--|
| 1x
4 mm

z1 | 12x
Ø7x50 mm

e1 | 6x
Ø15x12 mm #16

r1 |
|---|--|--|

7 

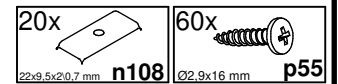
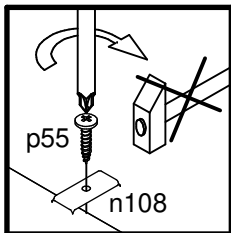
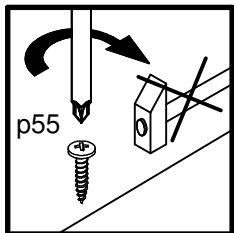
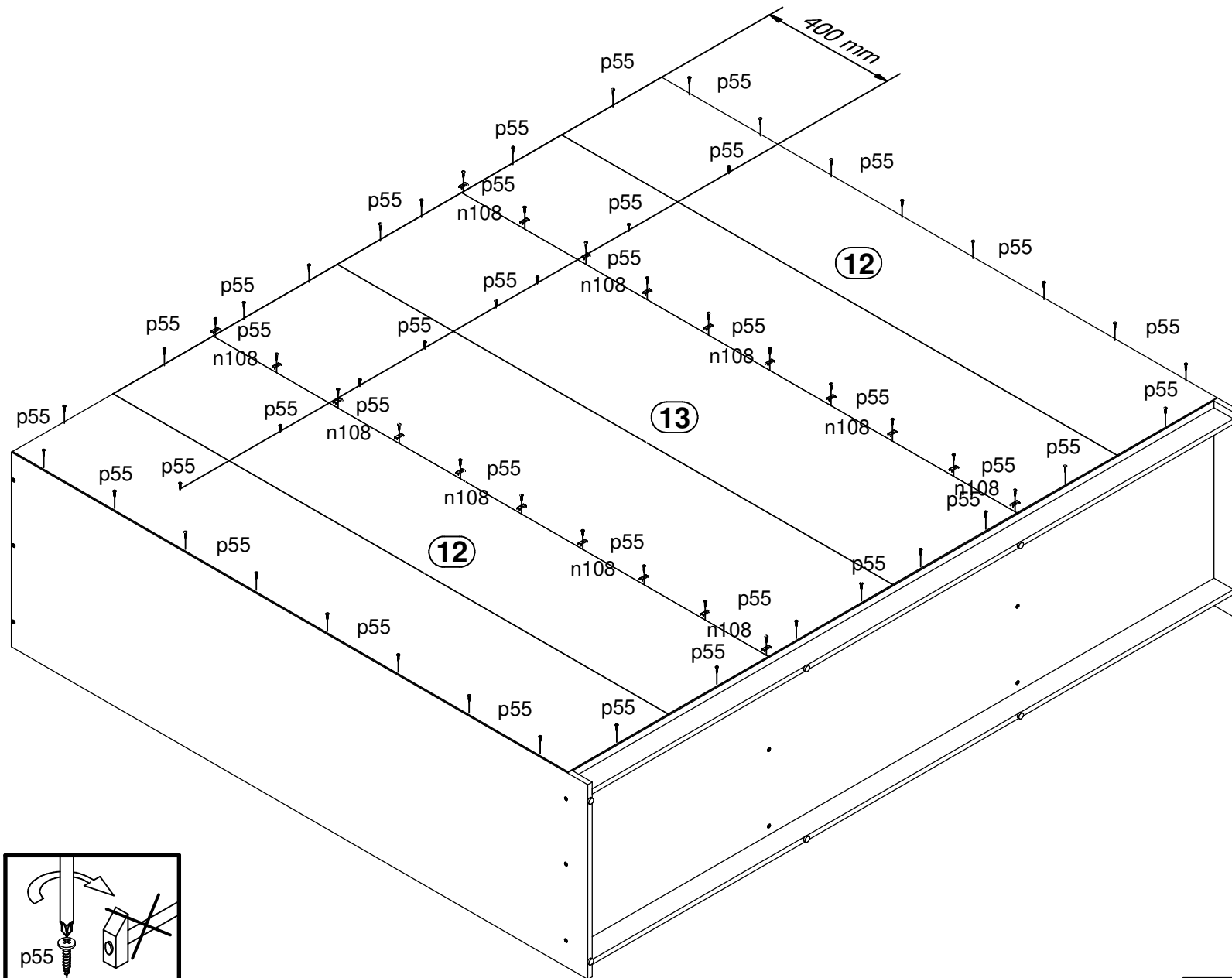
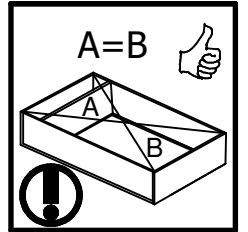

8 §6

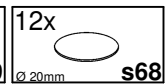
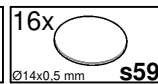
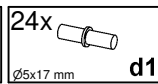
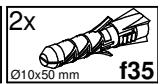
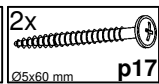
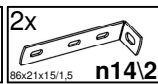
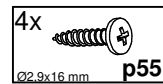
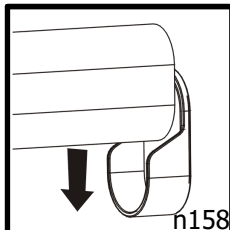
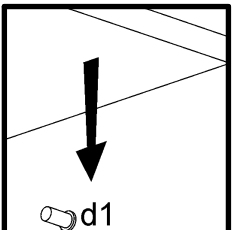
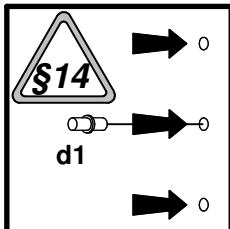
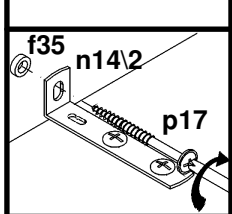
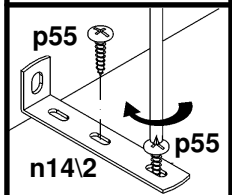
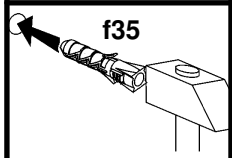
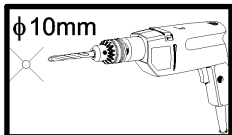
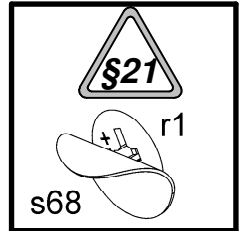
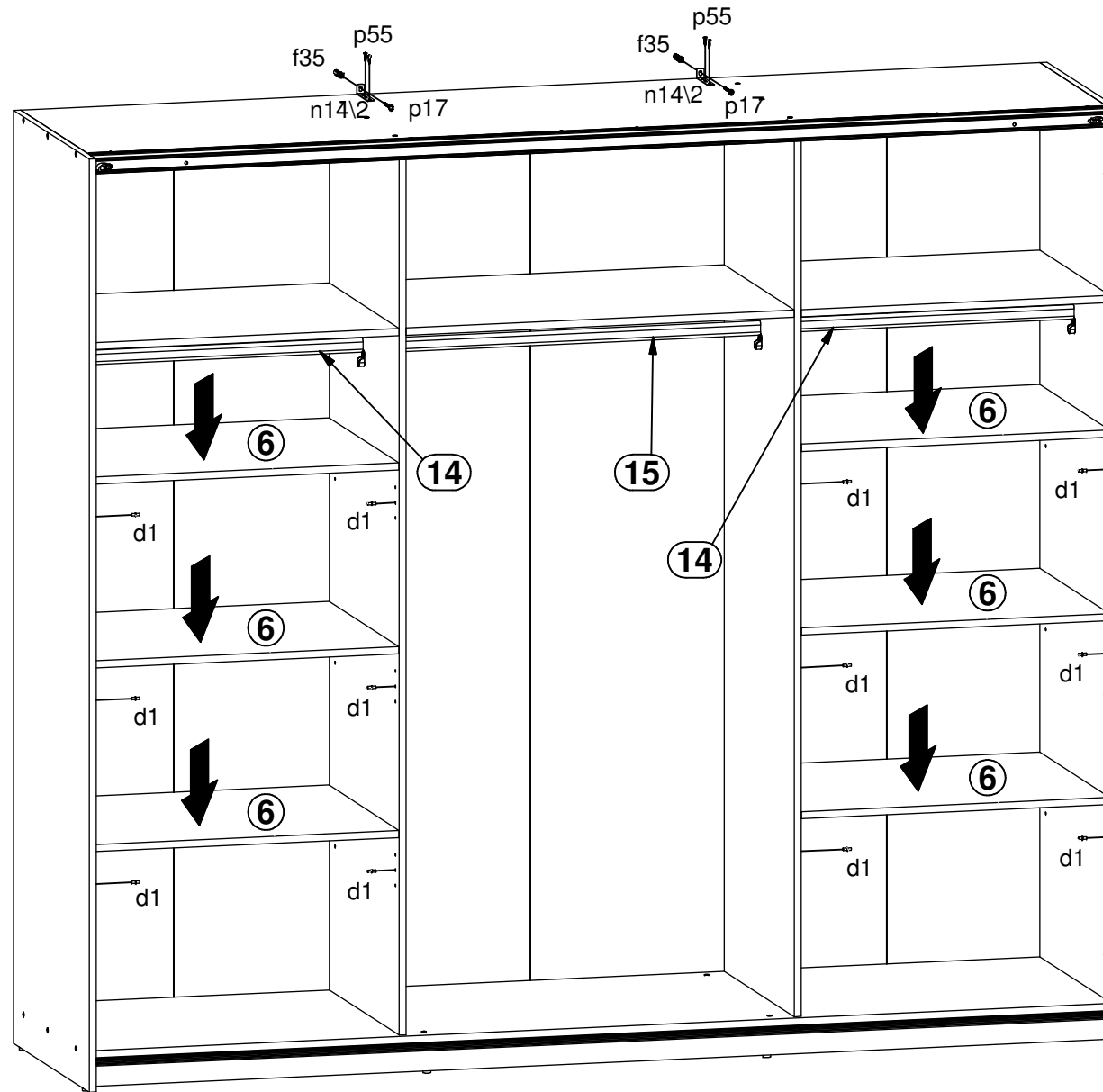

9

