

Junona Line K22-D1D/40/82P-FRN K22-DNW_100_82-P

A	B	C	D
1	K22-021	396	713
			3/3

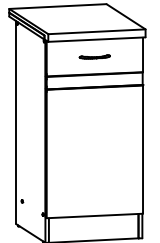

K22-DNW_100_82-P K22-D1D_40_82P

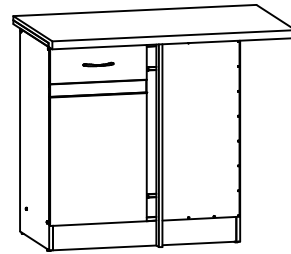
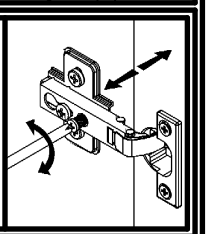
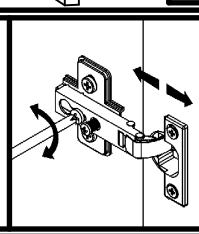
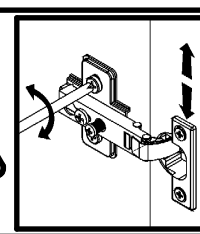
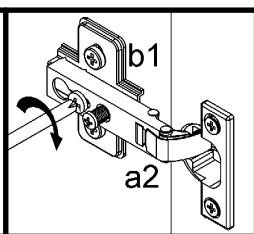
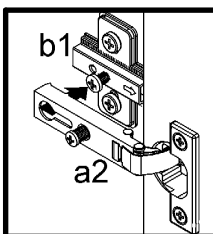
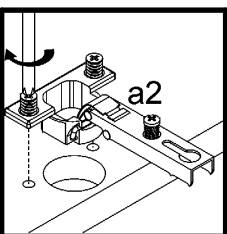
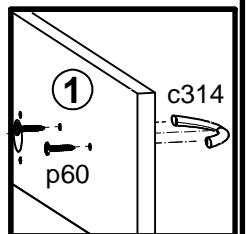
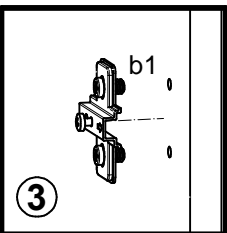
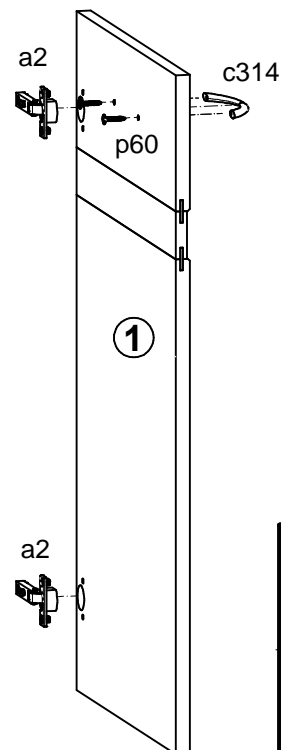
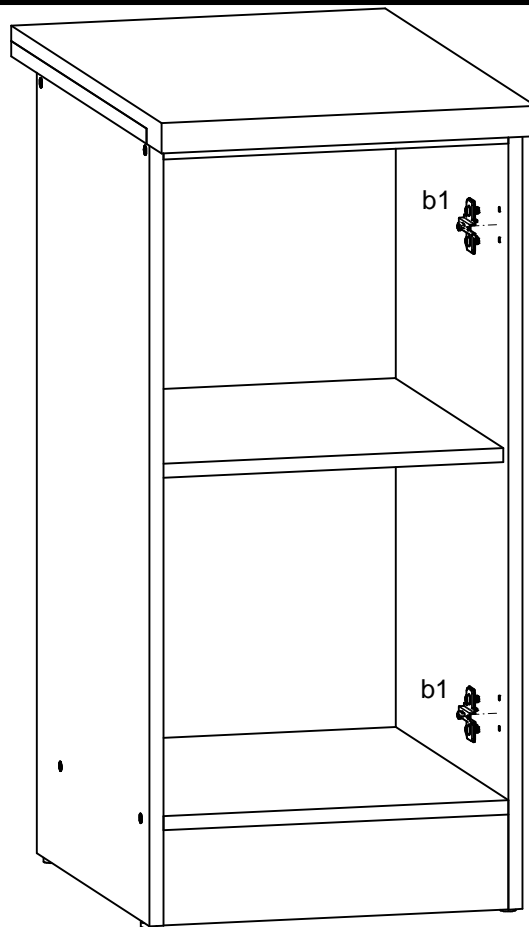
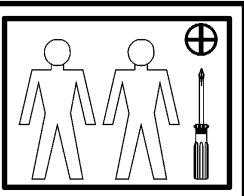
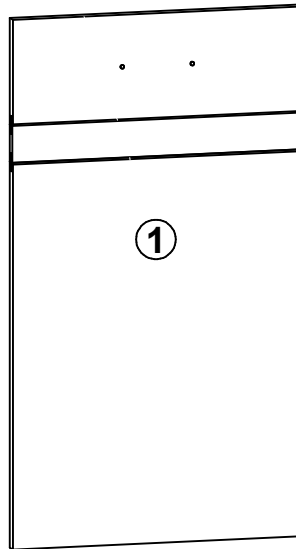

Junona Line

K22-D1D/40/82 L/P

A	B	C	D	
1	K22-107	820	450	1/3
2	K22-108	820	450	1/3
3	K22-203	400	600	2/3
4	K22-307	369	450	1/3
5	K22-308	368	430	1/3
6	K22-411	369	70	1/3
7	K22-412	369	70	1/3
8	K22-413	369	100	1/3
9	K22-906	715	393	1/3

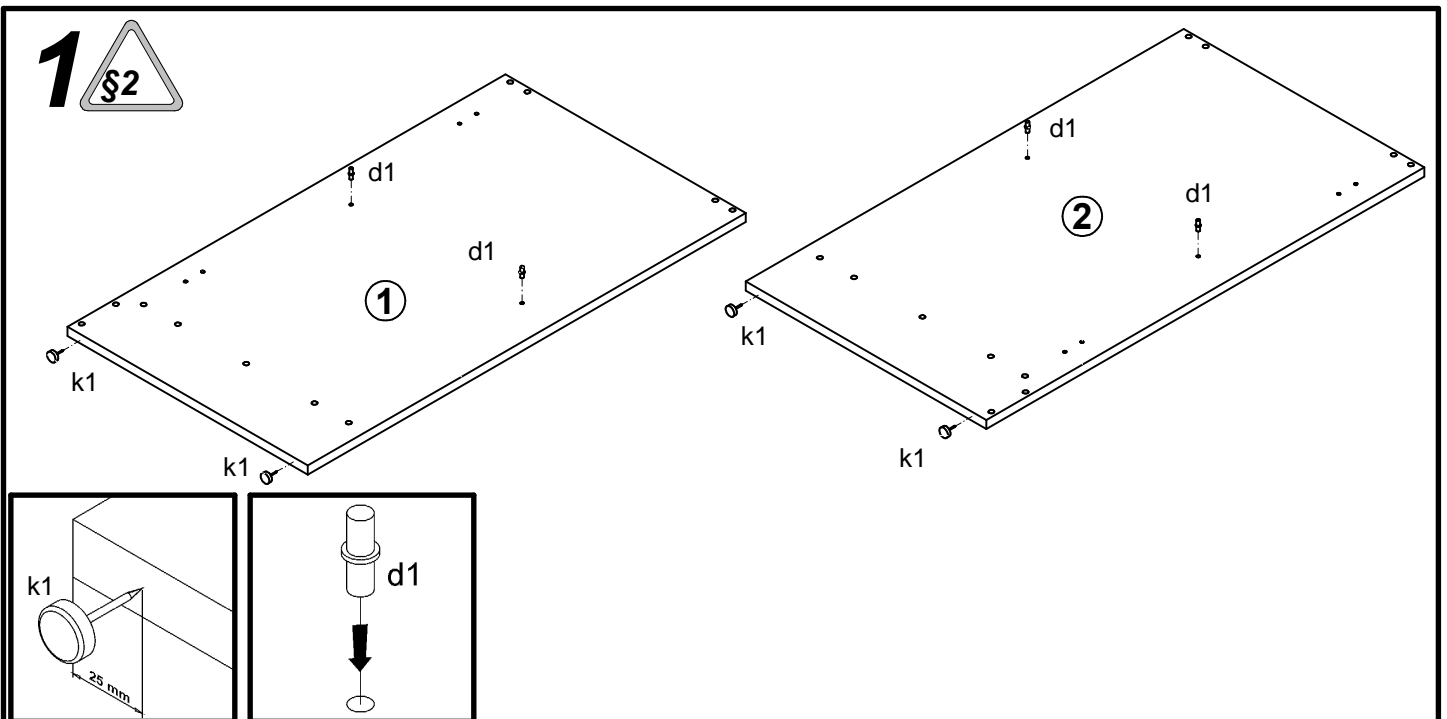
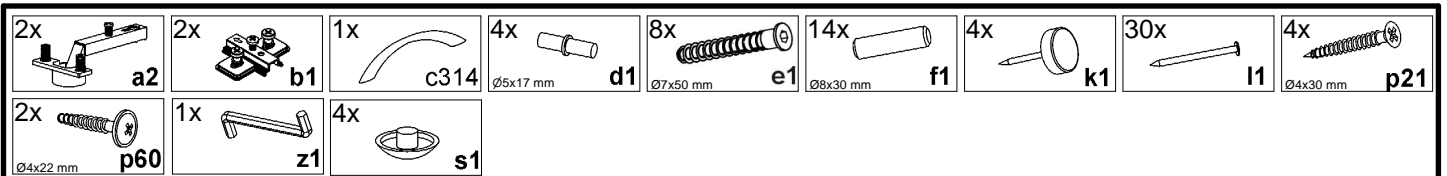
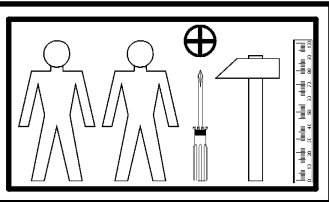
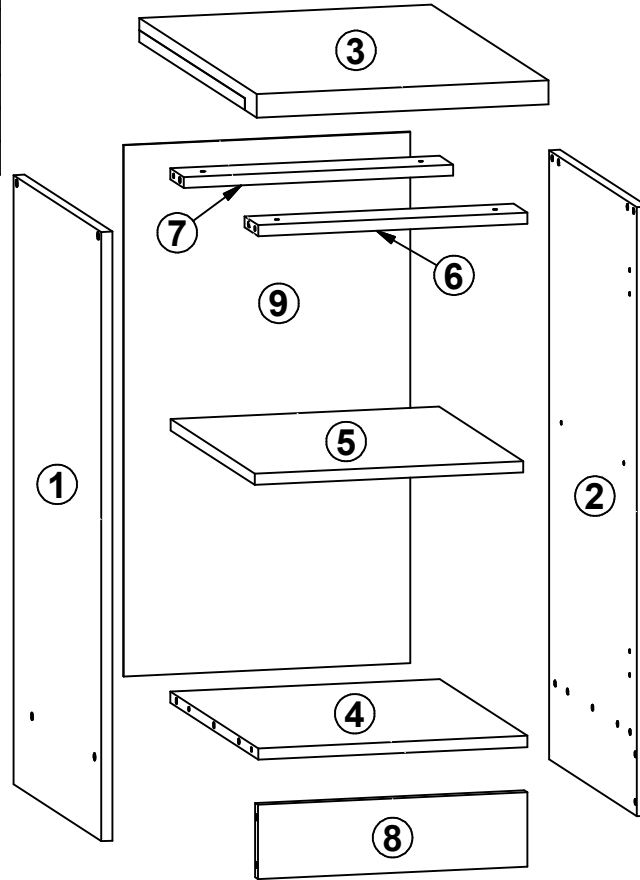
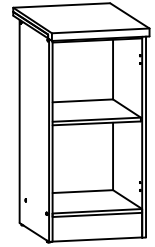

2 

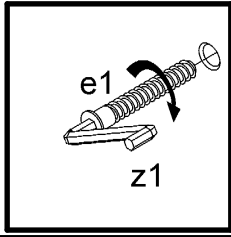
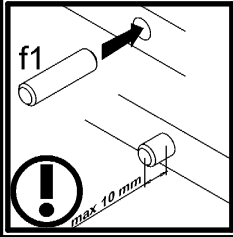
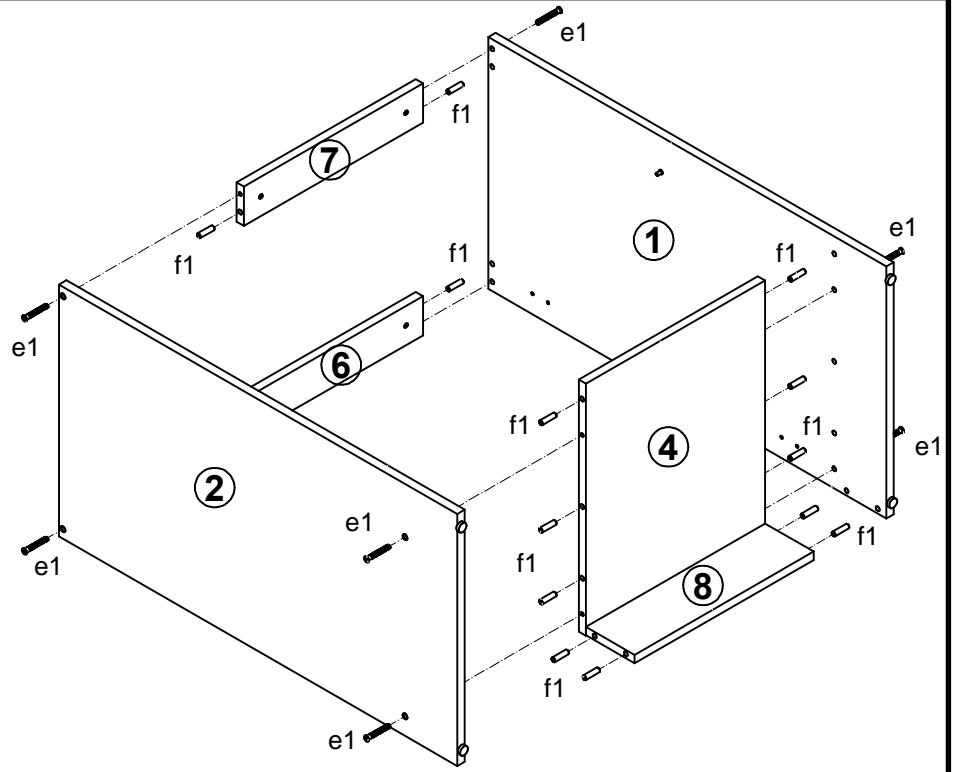

3

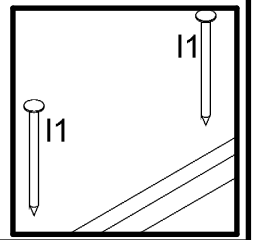
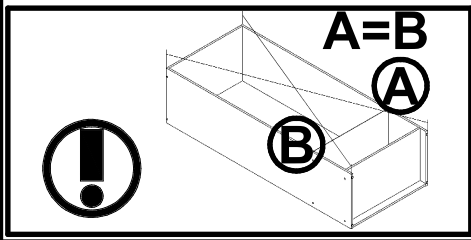
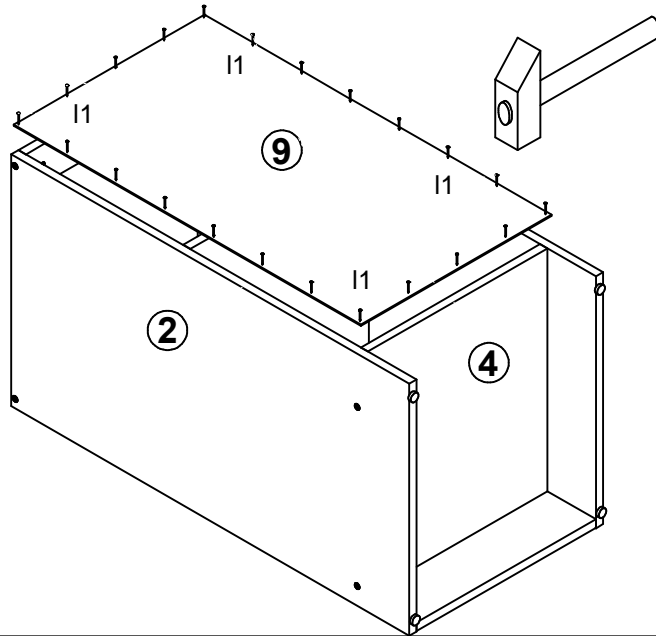

4

