

A	B	C1	C2	C3	D
1	M247-3004	798	280	22	1/1
2	M247-4501	1545	800	15	1/1

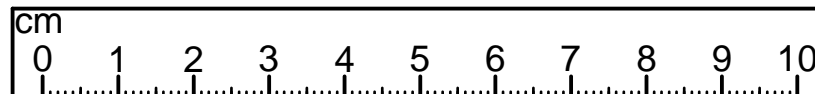

A

M247-PAN/15/8

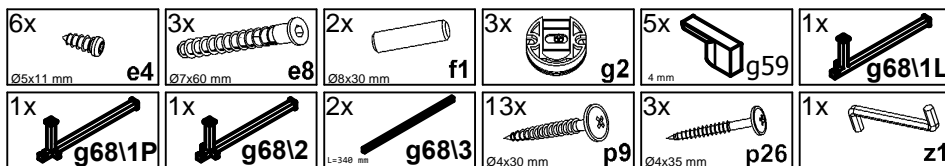
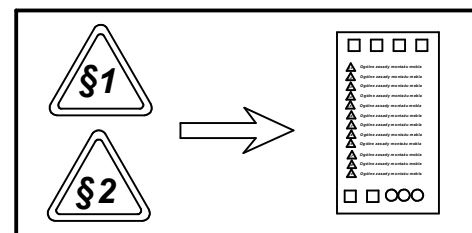
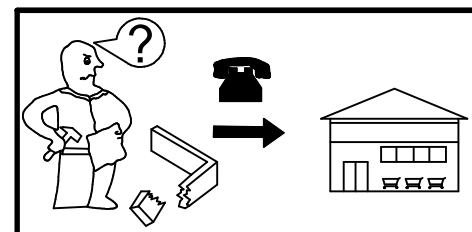
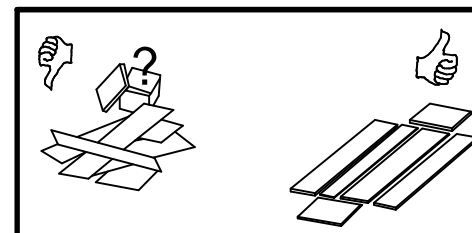
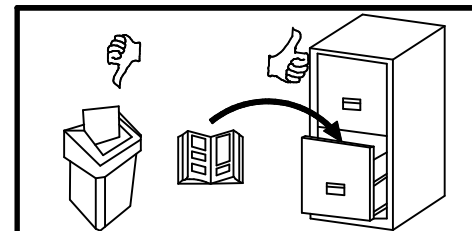
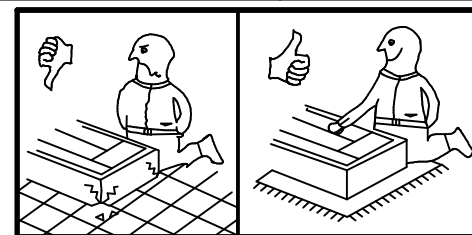
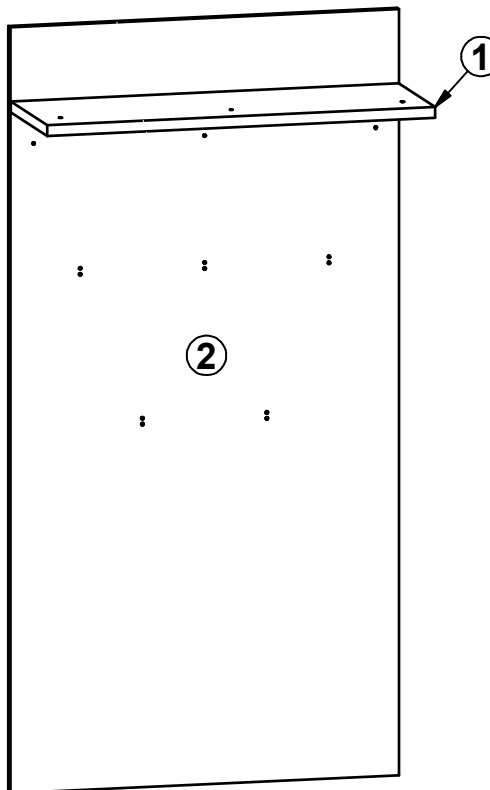
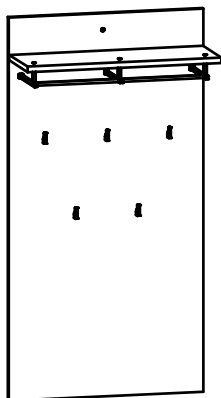
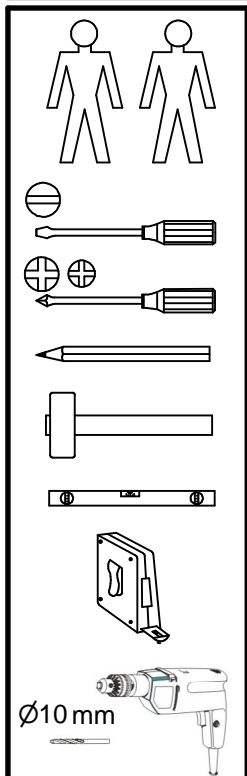
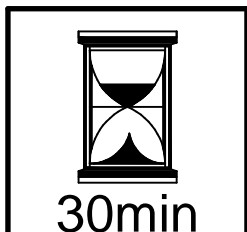
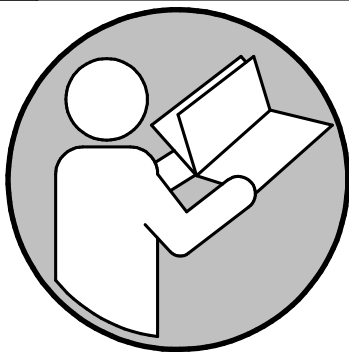
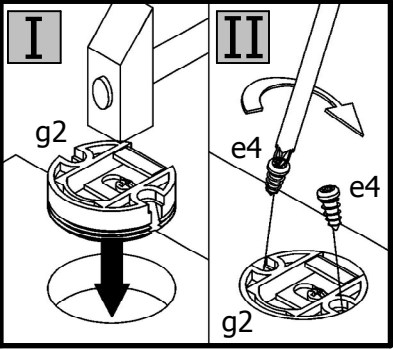

- 6x e4
Ø5x11 mm
- 3x g2

1

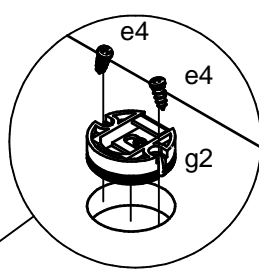

- 1x g68\1L
- 1x g68\1P
- 1x g68\2
- 2x g68\3
L=340 mm

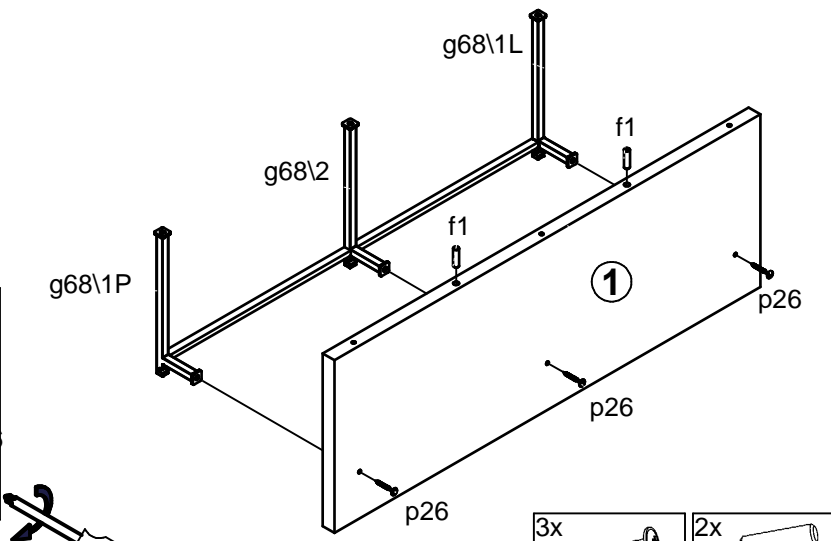
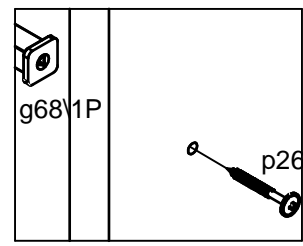
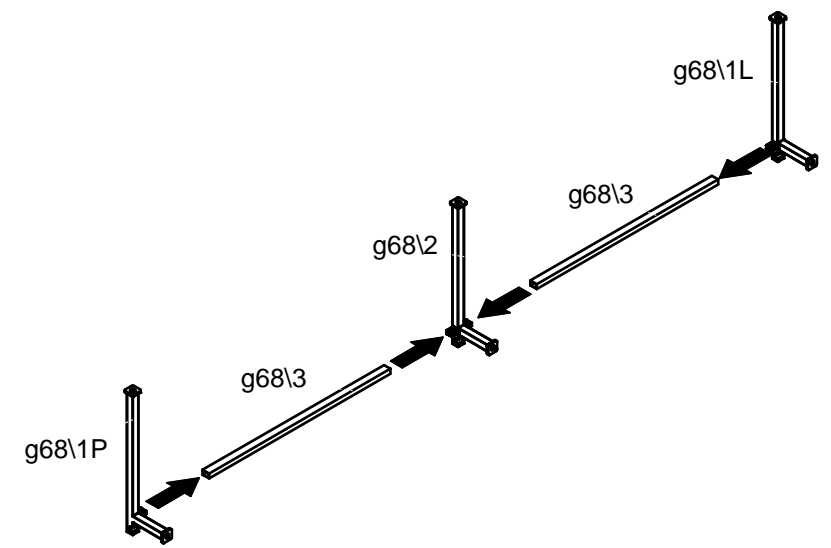
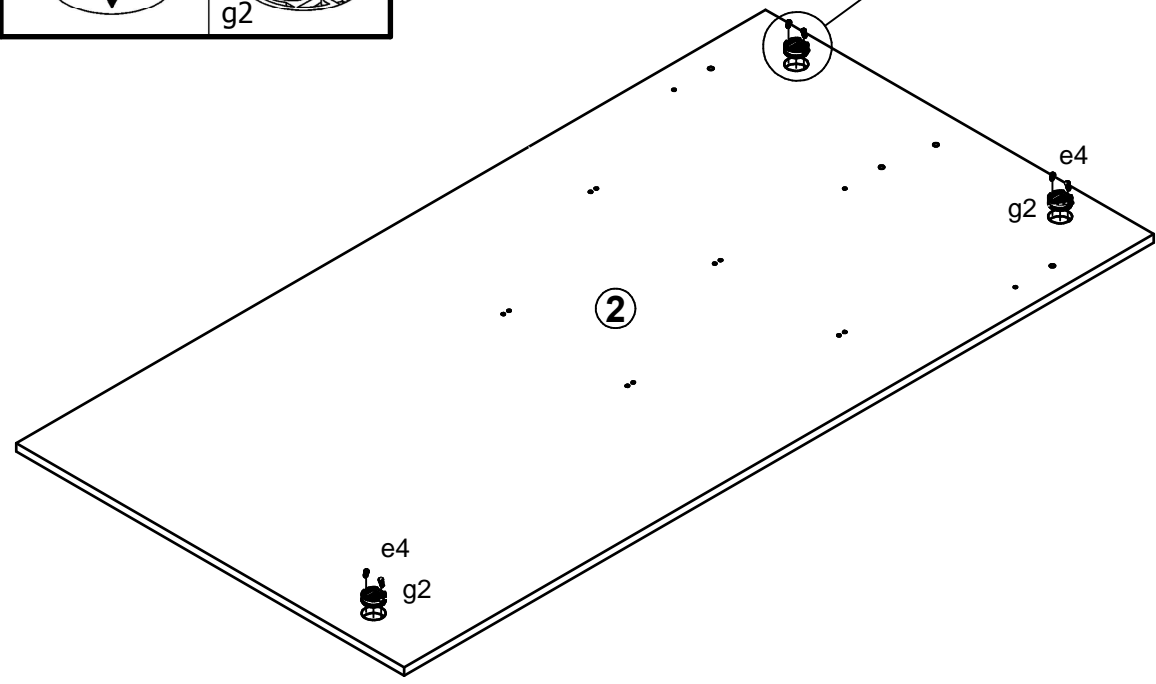

- 3x p26
Ø4x35 mm
- 2x f1
Ø8x30 mm

2

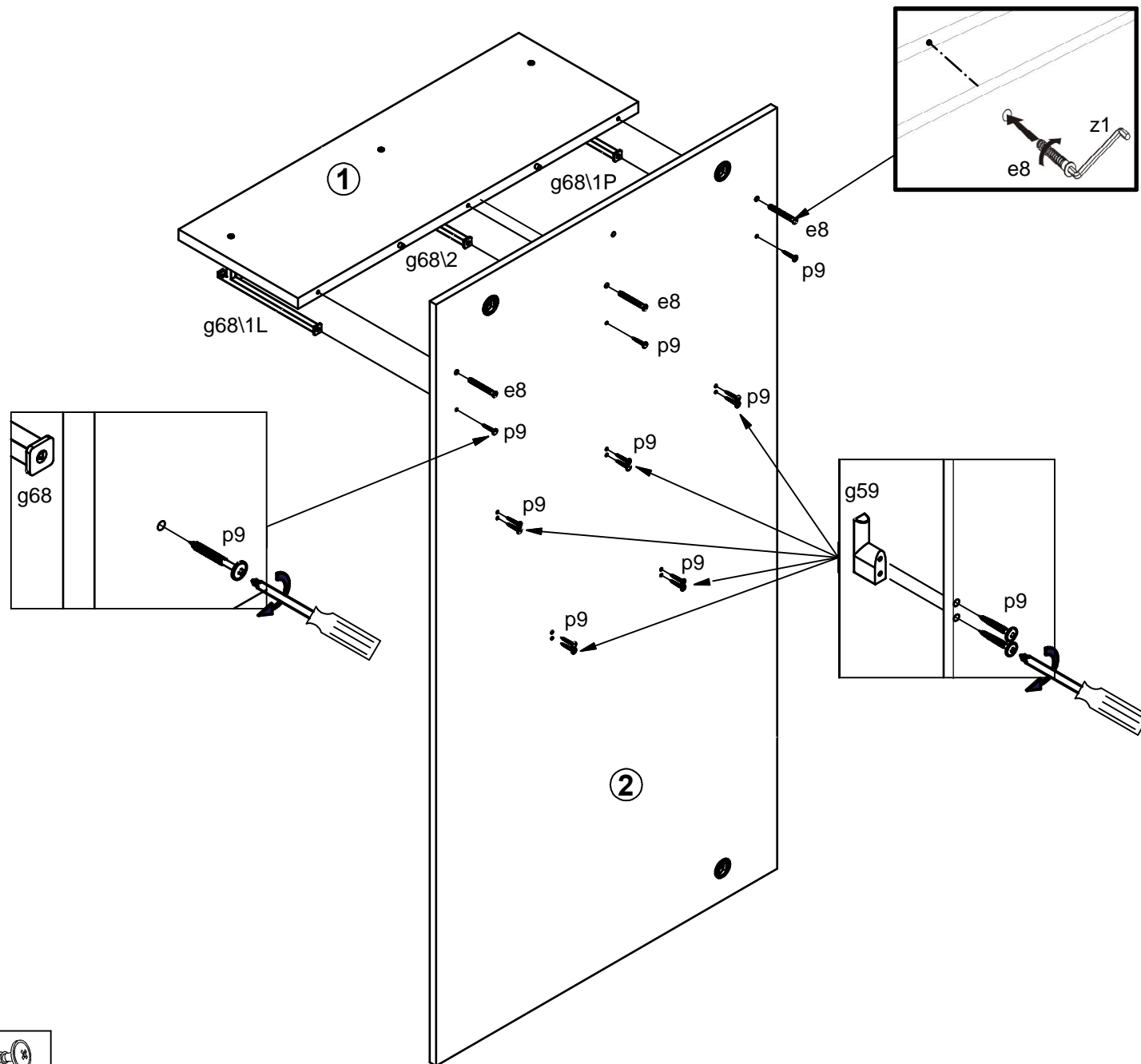

- 3x e8 $\varnothing 7 \times 60 \text{ mm}$
- 5x g59 4 mm
- 13x p9 $\varnothing 4 \times 30 \text{ mm}$

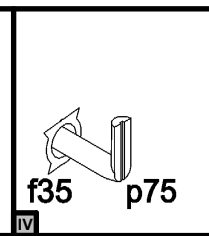
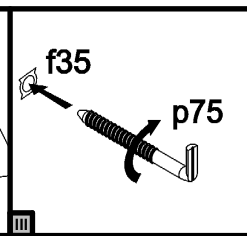
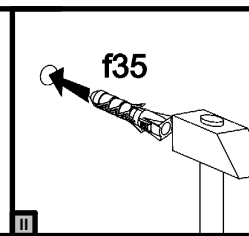
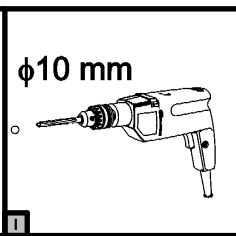
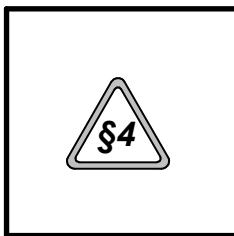
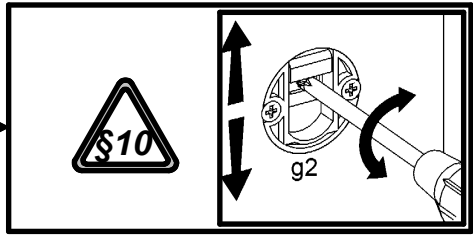
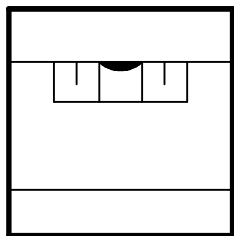

3

