

A

FLEX

F57-FRN-220/218/Z

A	B	C	D
1	F57-0034	1098	696 1/1
2	F57-0036	1098	696 1/1



3		1098	696 1/1
---	--	------	---------

4	w108\3	2090	- 1/2
5	Eg-sp_2090	2090	- 2/2

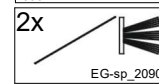
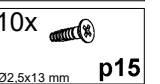
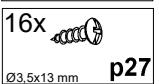
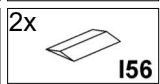
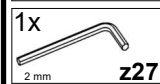
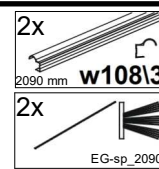
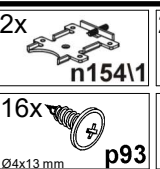
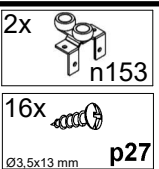
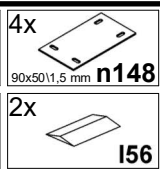
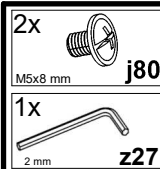
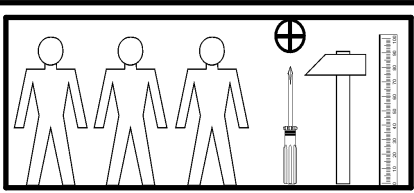
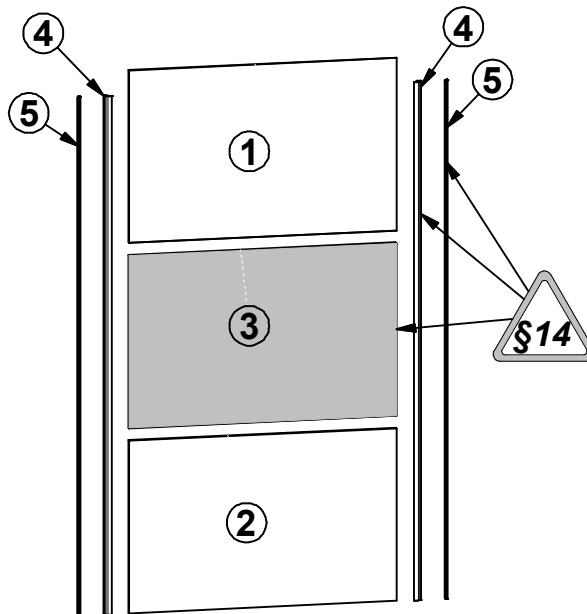

1 §2 §6 §11

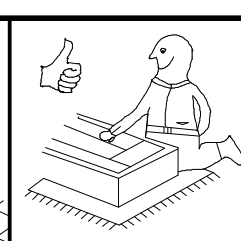
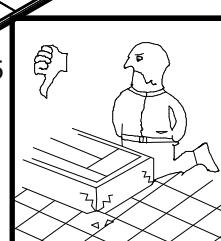
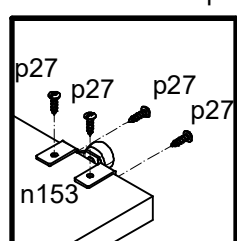
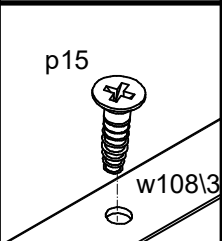
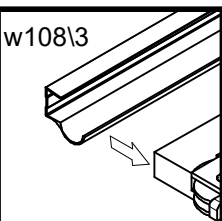
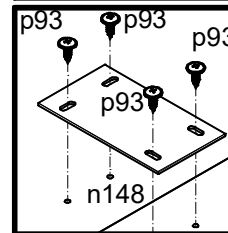
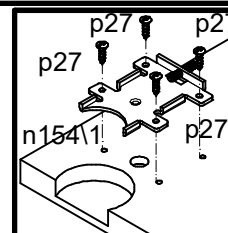
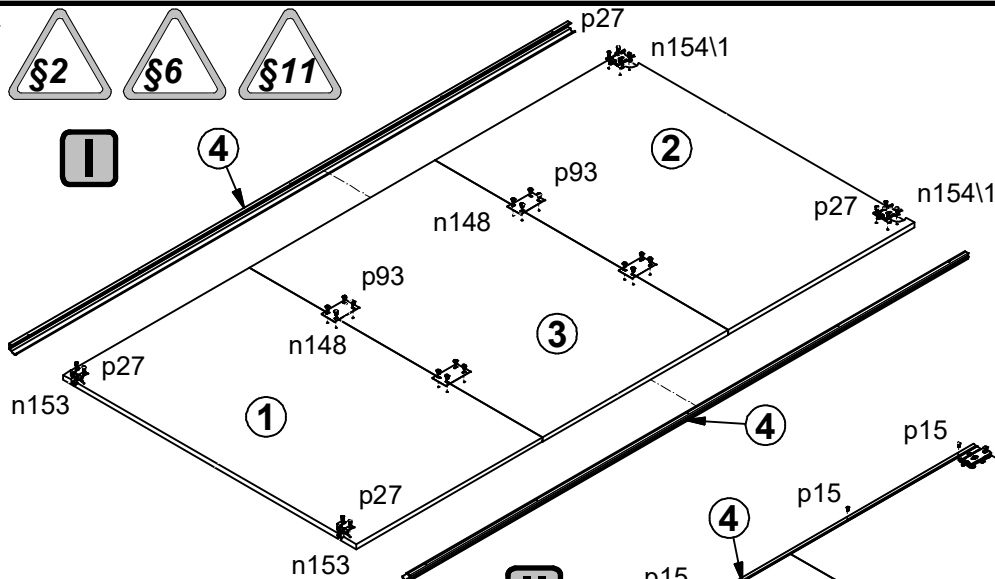

2

