

A

FLEX

F57-FRN-240/240/Z

A	B	C	D
1	F57-0016	1198	577
2	F57-0018	1198	577



3		1198	577
---	--	------	-----

4	w108\2	2310	-	1/2
5	Eg-sp_2310	2310	-	2/2

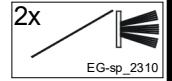
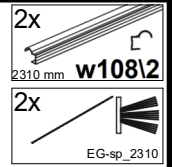
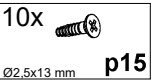
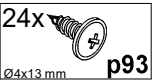
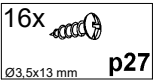
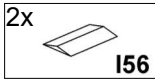
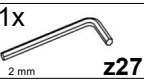
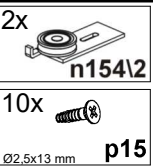
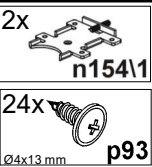
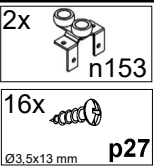
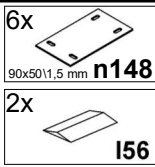
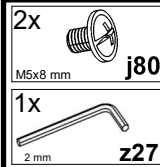
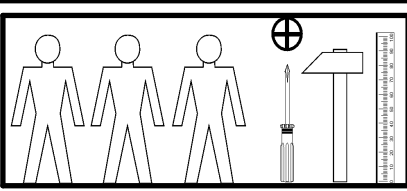
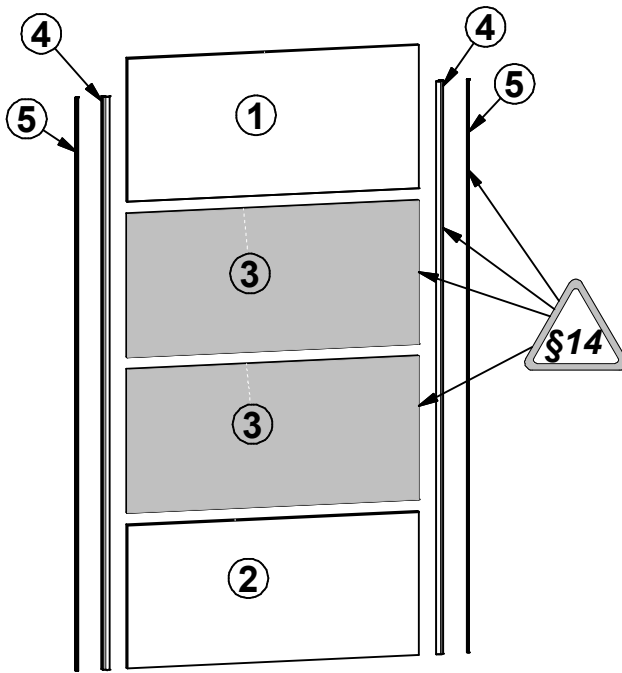

1 §2 §6 §11

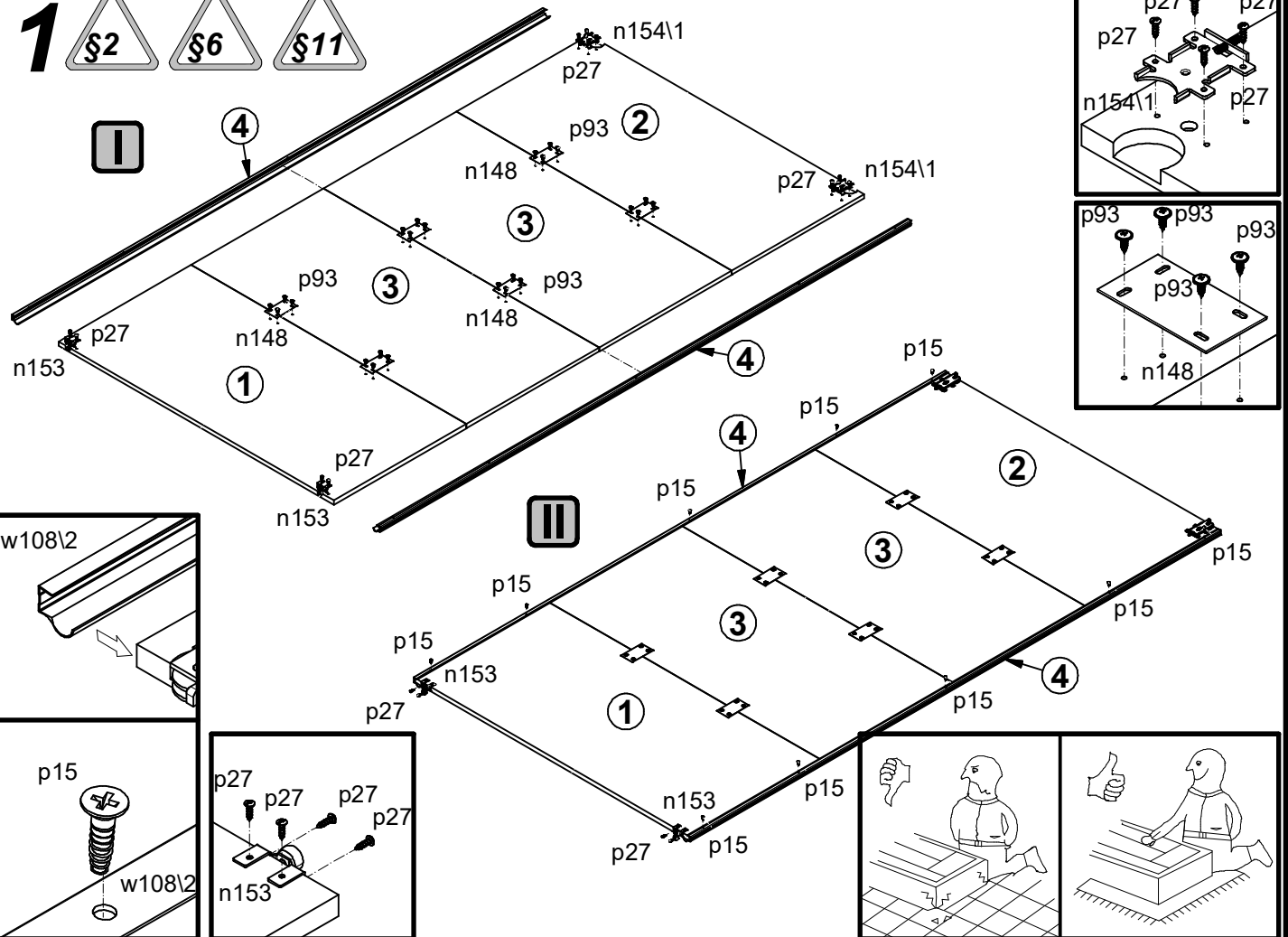

2

