

A

FLEX

F57-SZU3S/55/66

A	B	C	D
1	F57-0051	540	190
2	F57-3002	550	533
3	F57-9028	510	457
4	ZK3-5052	500	127
5	ZK4-517	450	140
6	ZK4-518	450	140

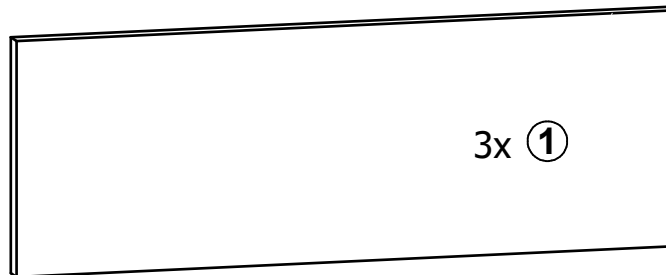
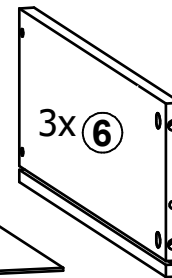
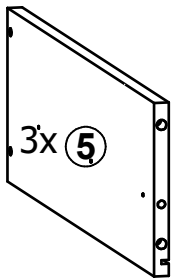
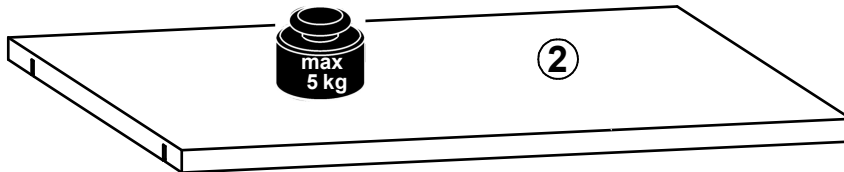
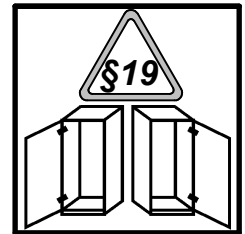
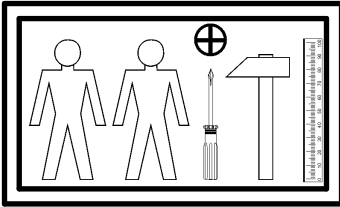
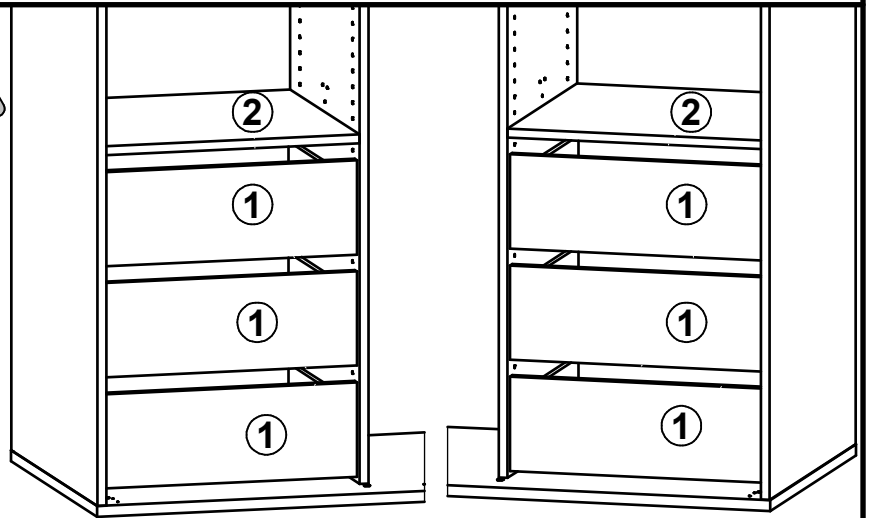

12x Ø6x13 mm e3	12x Ø6.5x40 mm f25	6x Ø6x30 mm f9	18x Ø3.5x12 mm p140	3x Ø3.5x16 mm p25	3x Ø3.5x10 mm p35	12x Ø3.5x16 mm p38	12x Ø12x10.5 mm #12 r15	4x Ø20x12 mm #16 r36
4x 6.7/7.8 r37	12x 20/11 r42	3x 450 mm t38	6x L450 mm w206\2	6x L450 mm w206\1				

1 

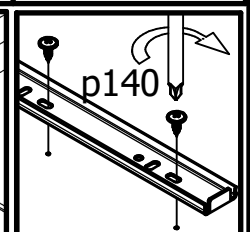
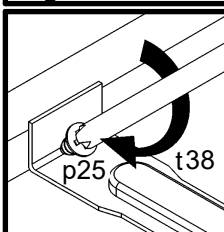
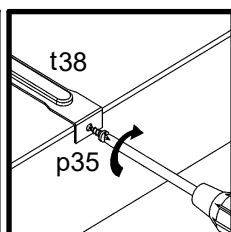
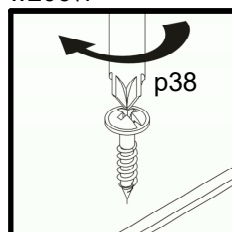
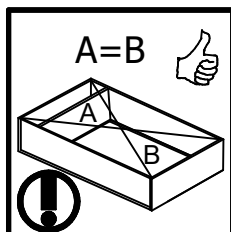
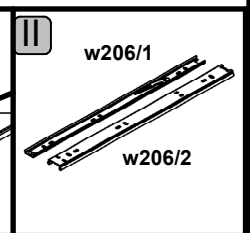
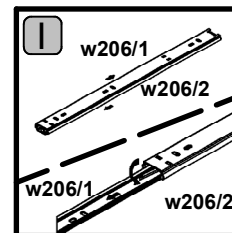
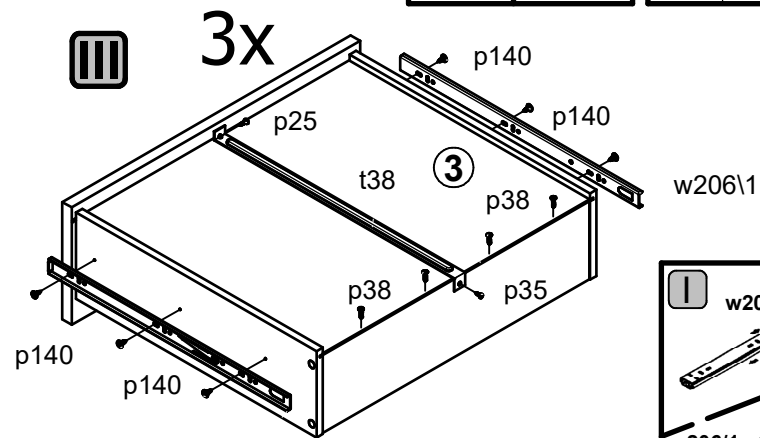
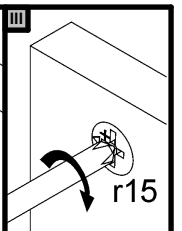
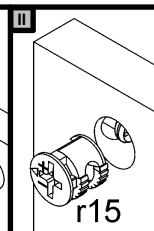
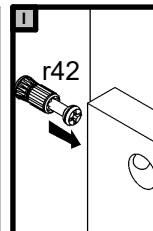
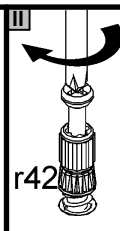
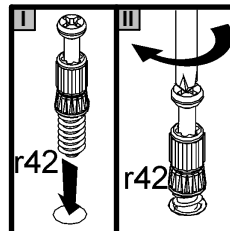
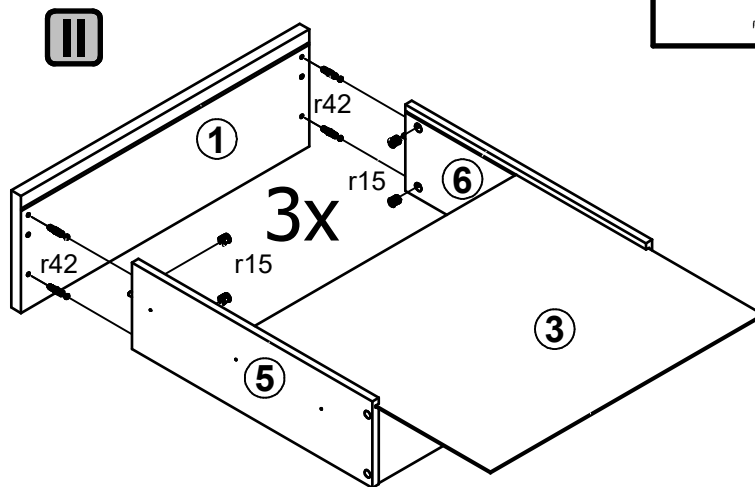
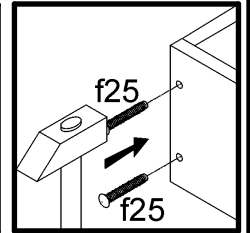
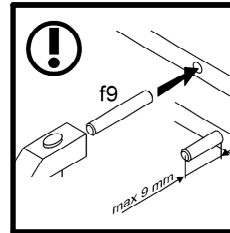
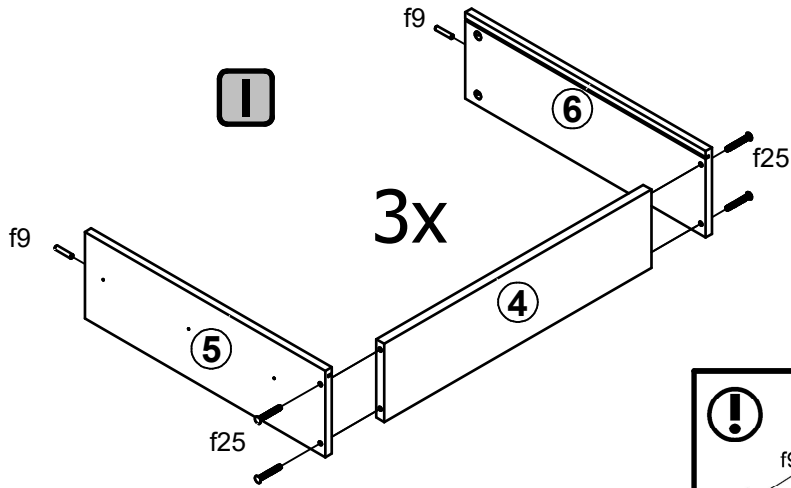

2

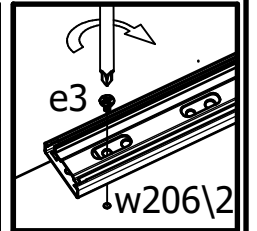
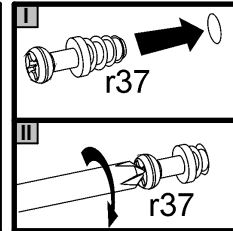
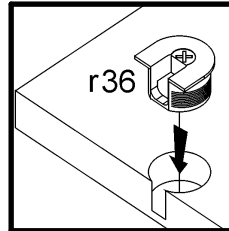
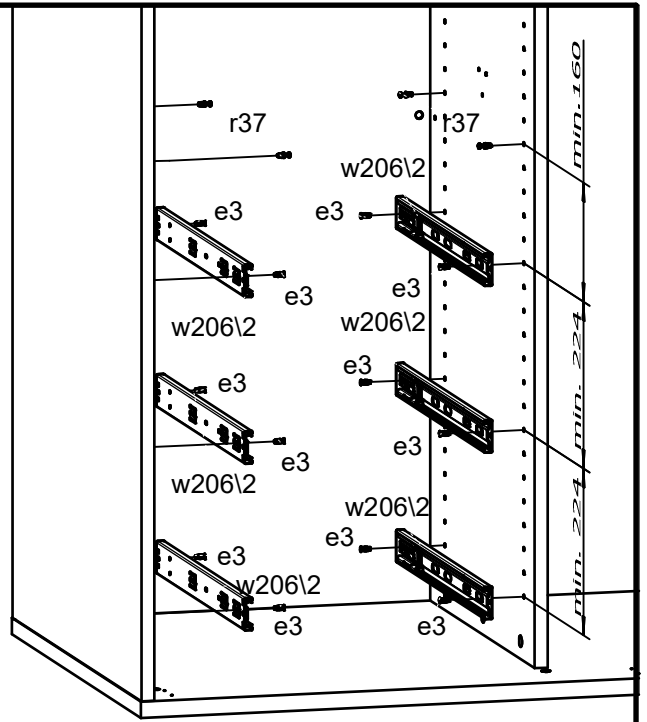
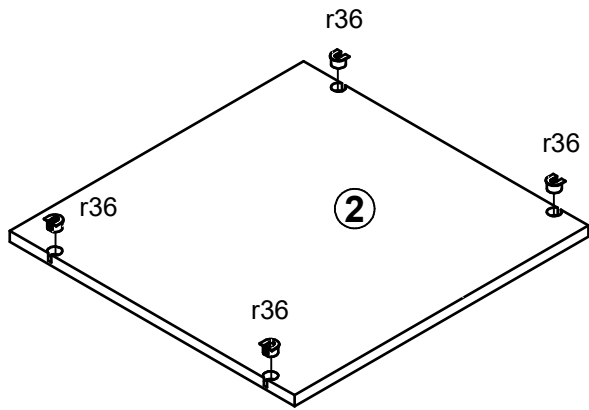

3

