

- □ □ □
- ▲ Opilne zasady montażu mebli
- ▲ Opilne zasady montażu mebli
- ▲ Opilne zasady montażu mebli
- ▲ Opilne zasady montażu mebli
- ▲ Opilne zasady montażu mebli
- ▲ Opilne zasady montażu mebli
- ▲ Opilne zasady montażu mebli
- ▲ Opilne zasady montażu mebli
- ▲ Opilne zasady montażu mebli
- ▲ Opilne zasady montażu mebli
- ▲ Opilne zasady montażu mebli
- □ ○ ○

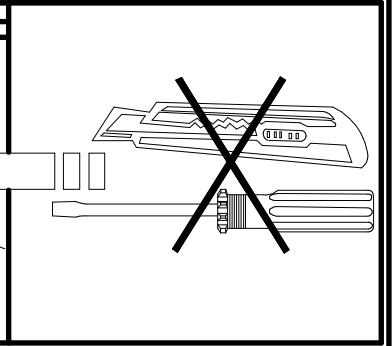

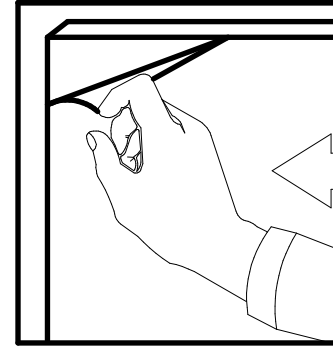

Ø10 mm

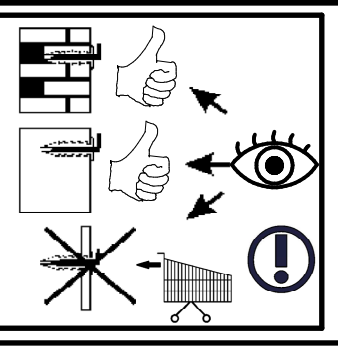
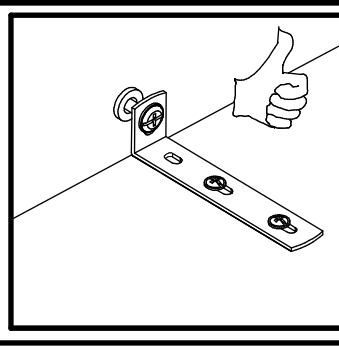
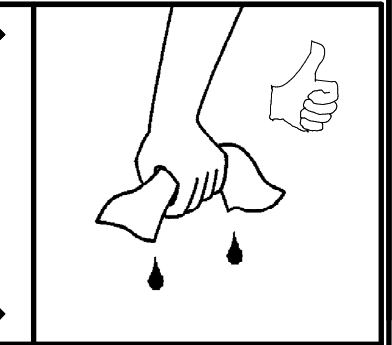
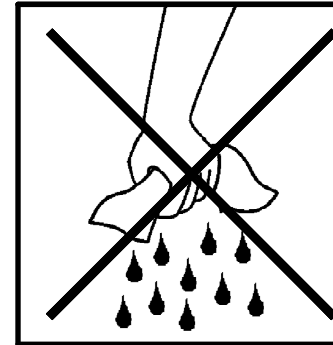
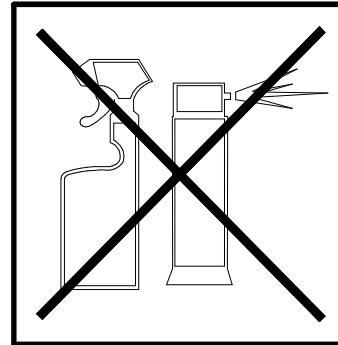
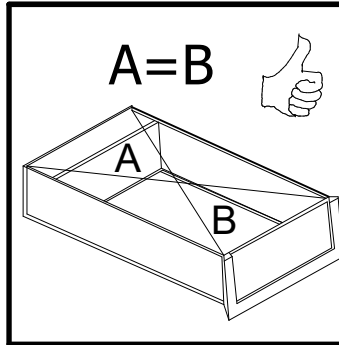
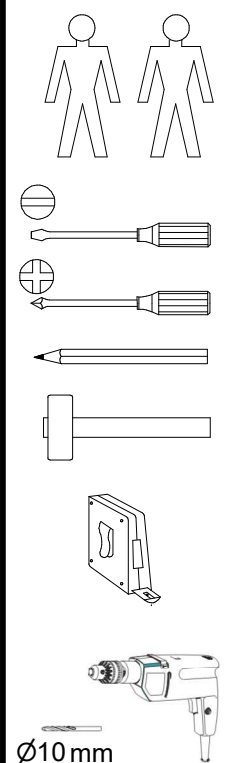
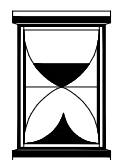

2h

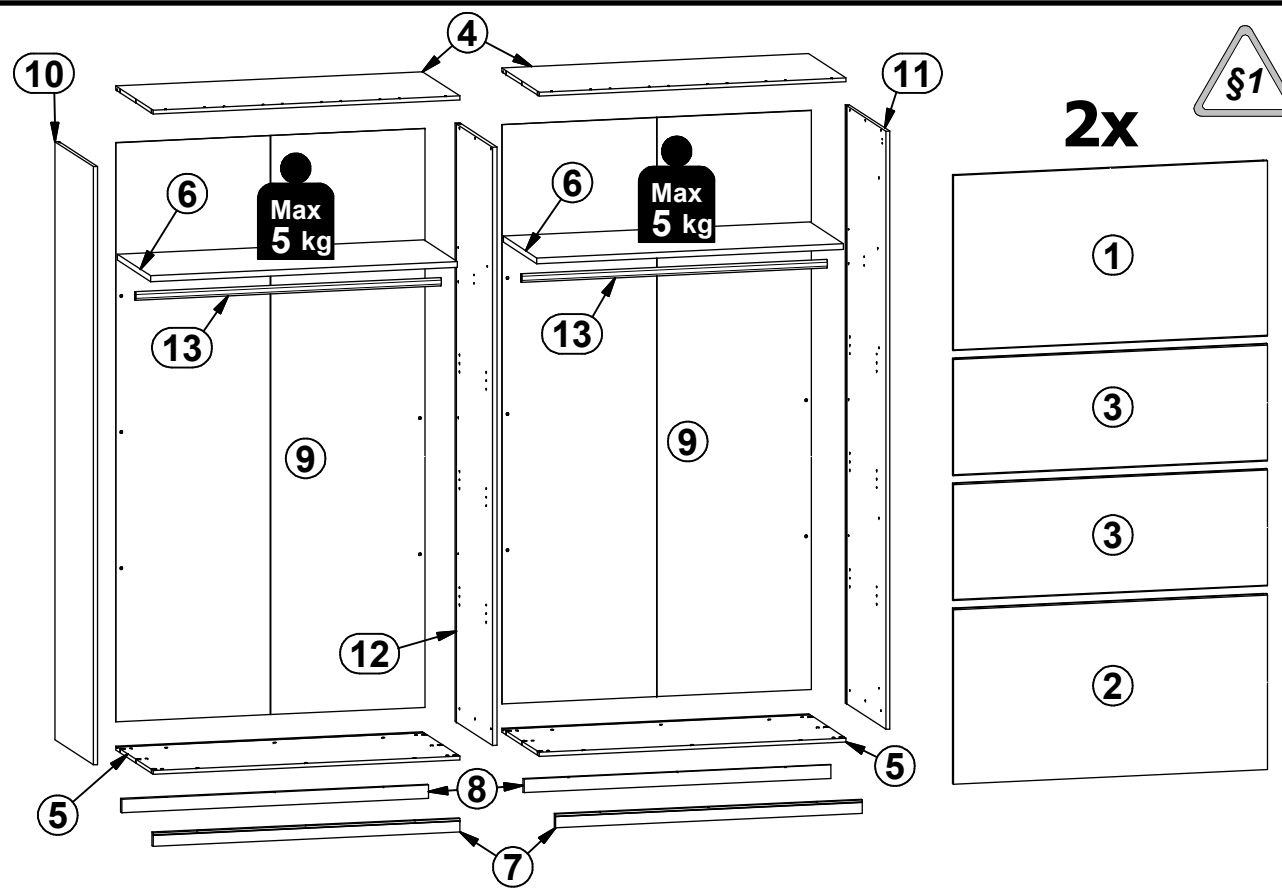

A	B	C (mm)			D
1	L112-0005	1204	660	15	7/7
2	L112-0006	1204	660	15	7/7
3	L112-0007	1204	440	15	6/7
4	L112-3003	1176	535	15	3/7
5	L112-3004	1176	535	15	3/7
6	L112-3005	1176	480	22	4/7
7	L112-4005	1176	51	15	3/7
8	L112-4006	1176	51	15	3/7
9	L112-9302	2178	1185	2,5	2/7
10	L139-1010	2250	551	15	1/7
11	L139-1011	2250	580	15	2/7
12	L139-1012	2250	535	18	1/7
13	dr-1171	1171	30	15	3/7

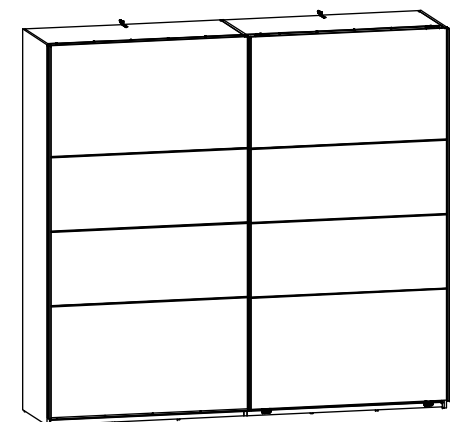







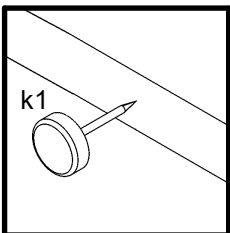
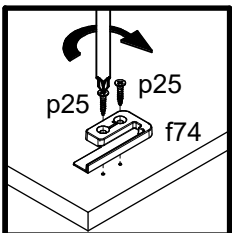
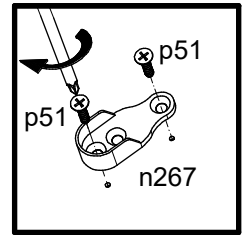
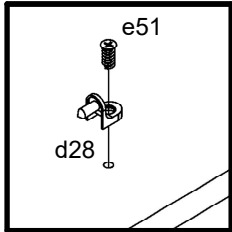
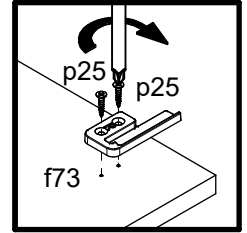
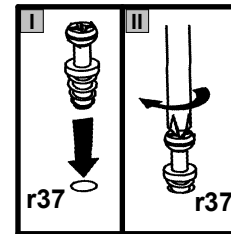
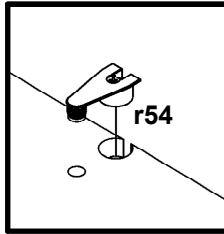
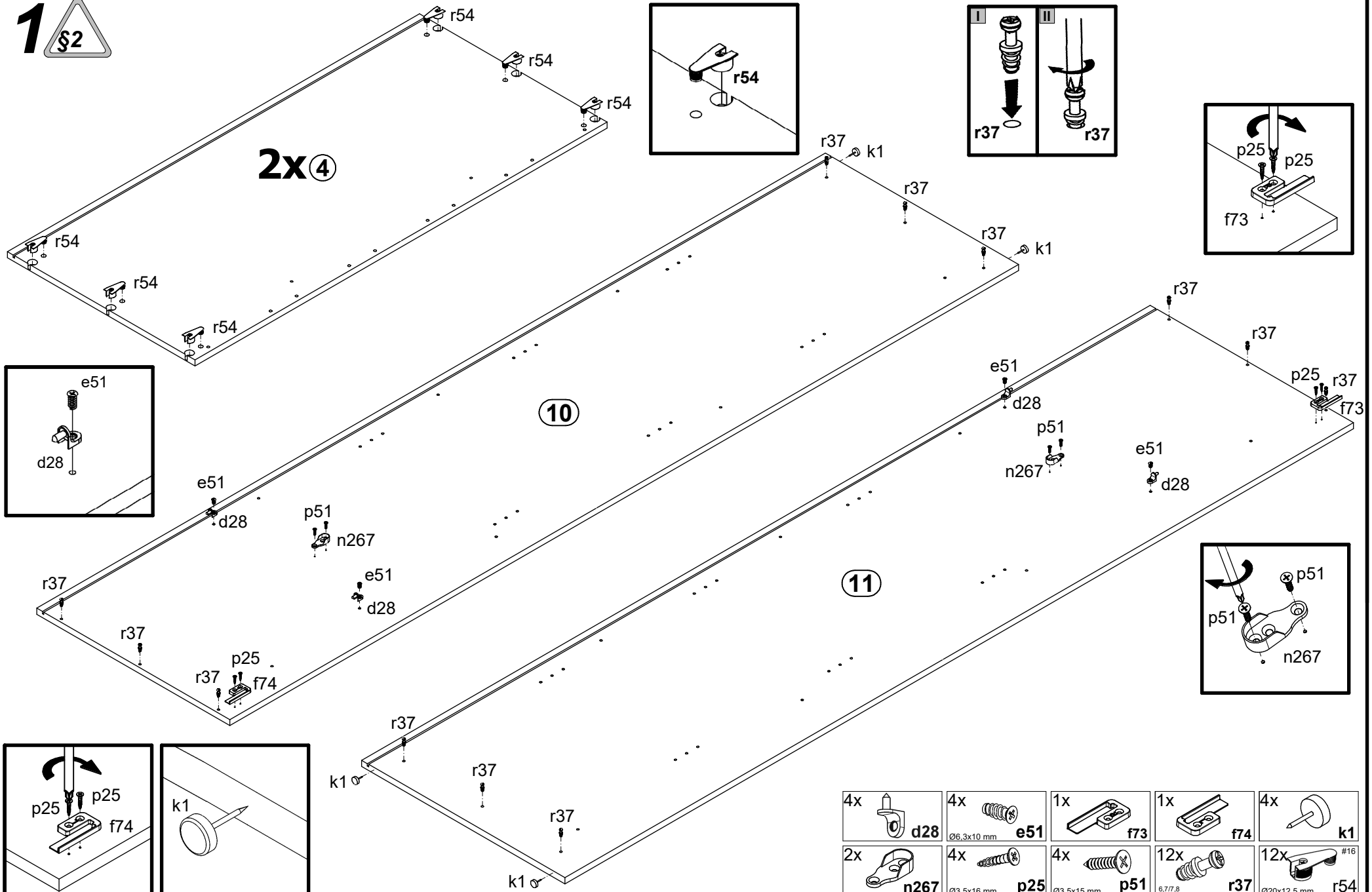

D
3/7, 5/7

12x d20	8x d28	3x EG-sp. 2200	12x Ø7x50 mm e1	24x Ø6,3x13 mm e5	12x Ø6,3x10 mm e50	8x Ø6,3x10 mm e51	2x Ø10x50 mm f35	2x f69	2x f70	1x f71	1x f72	1x f73
1x f74	2x f75	2x f76	4x f77	10x M4x5 mm j84	10x M4x10 mm j106	10x Ø5x15 mm j140	2x j196	14x k1	20x l2	6x l63	2x 86x21x15/1,5 n14 2	12x 90x50/1,5 mm n148
1x n238	1x n239	1x n240	1x n241 2	4x n267	2x Ø5x60 mm p17	4x Ø3,5x16 mm p25	21x Ø3,5x15 mm p51	96x Ø4x13 mm p93	24x 6,7/7,8 r37	24x Ø20x12,5 mm r54	12x s1	14x Ø14x0,5 mm s59
2x 35x9 mm s113	1x 2200 mm w118 7	3x 2200 mm w136 3	1x L-2368 mm w249 2	1x L-2364 mm w250 2	1x 4 mm z1	1x 5 mm z17						

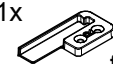
**1** §2

**2x** ④

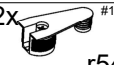

4x  <b>d28</b>	4x  <b>e51</b> Ø6,3x10 mm	1x  <b>f73</b>	1x  <b>f74</b>	4x  <b>k1</b>
2x  <b>n267</b>	4x  <b>p25</b> Ø3,5x16 mm	4x  <b>p51</b> Ø3,5x15 mm	12x  <b>r37</b> 6,7/7,8	12x  <b>r54</b> Ø20x12,5 mm #16

2 §2

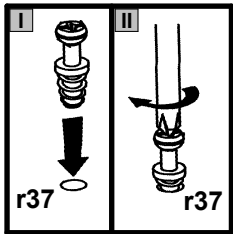
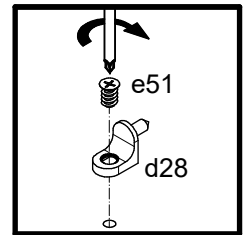
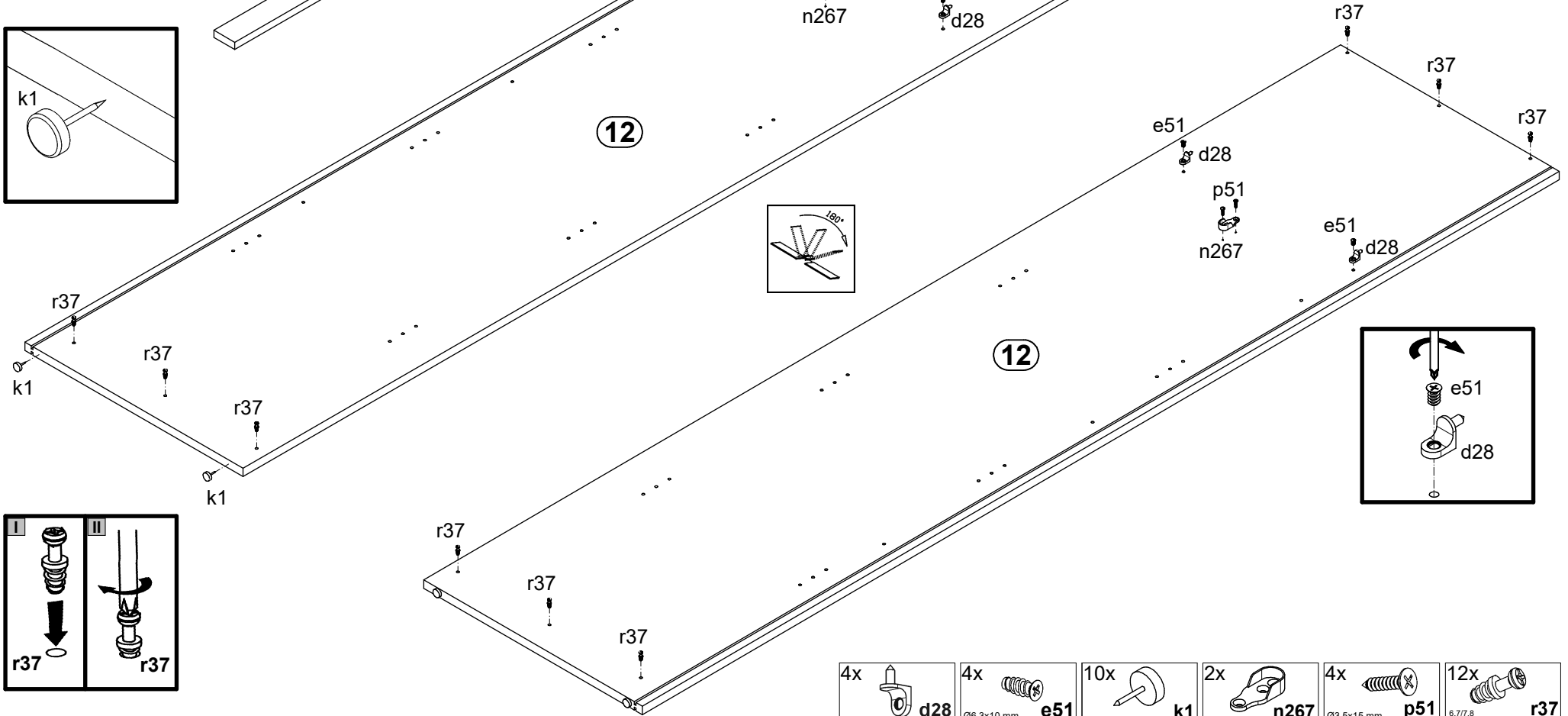
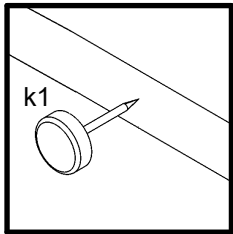
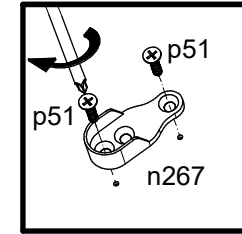
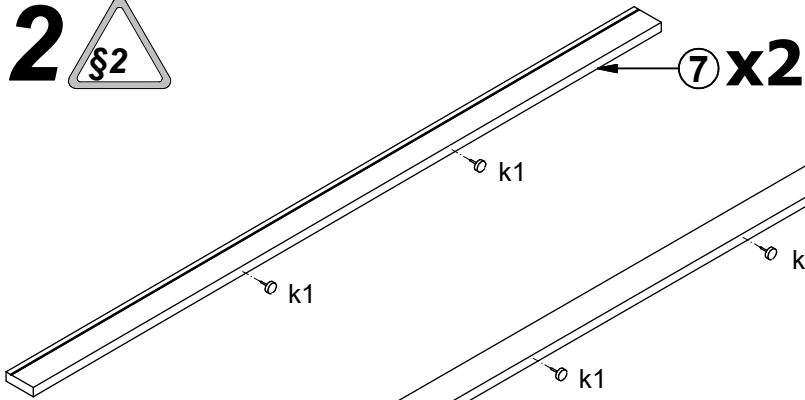

- 4x d28
- 4x Ø6,3x10 mm e51
- 10x k1
- 2x n267
- 4x Ø3,5x15 mm p51
- 12x 6,7/7,8 r37

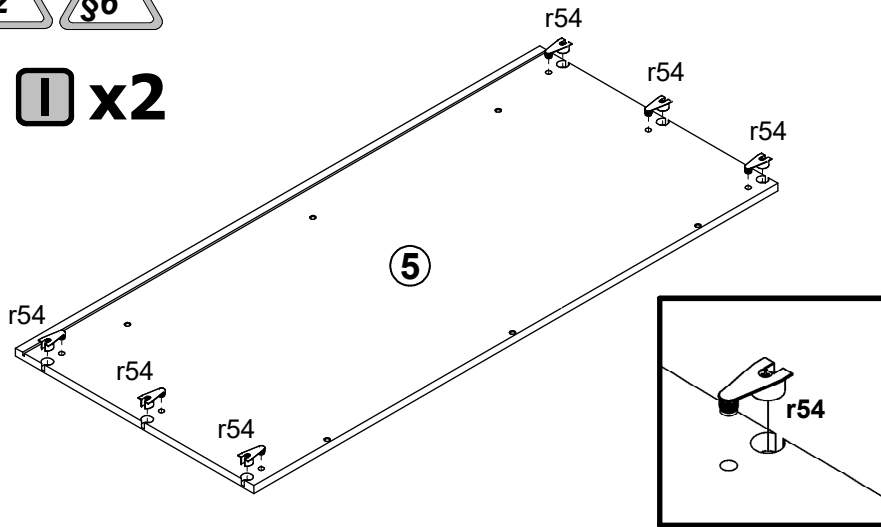

**3**  

**I** x2

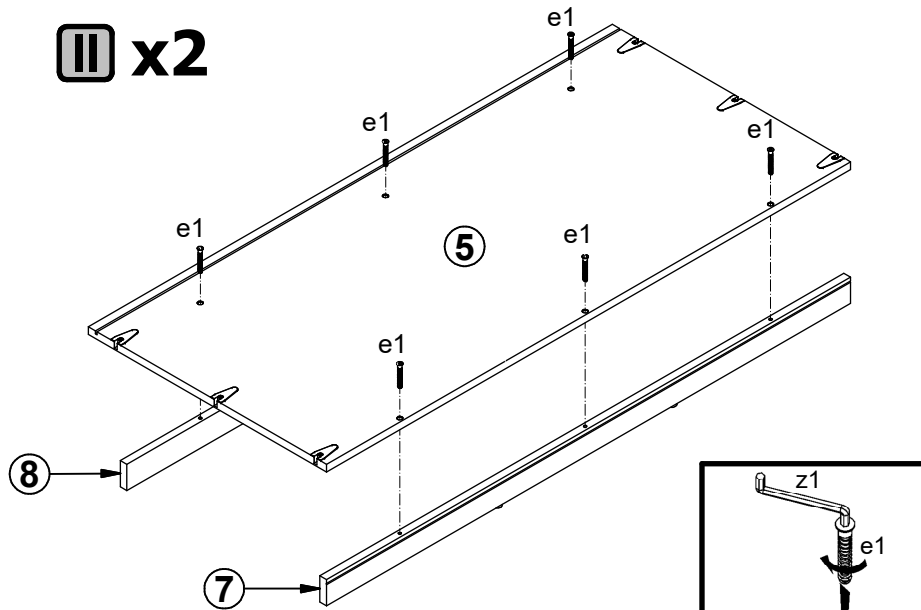

**II** x2



- 12x  e1 12x  #16 r54 1x  4 mm z1

**4** 

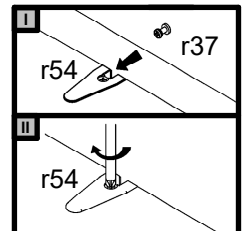
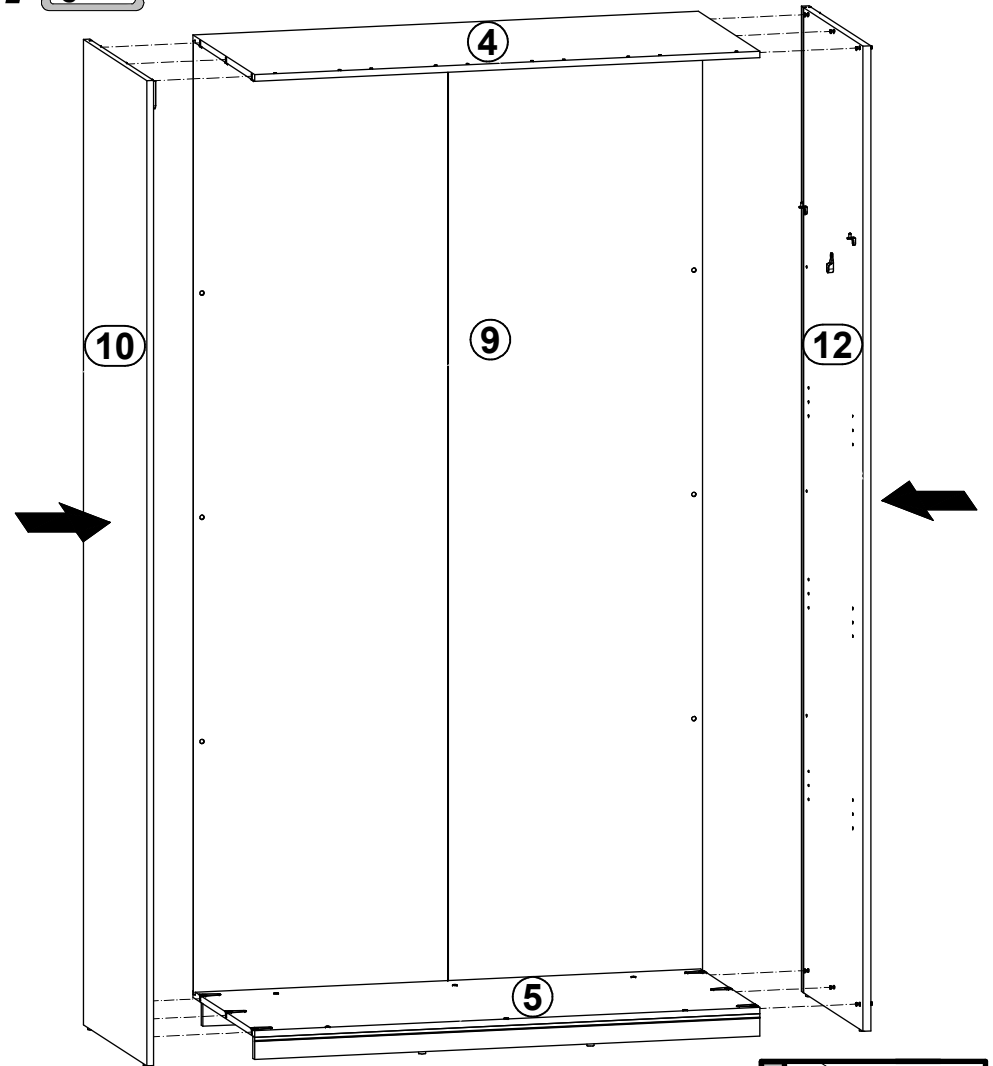

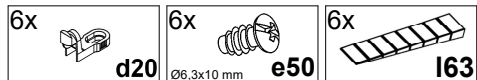
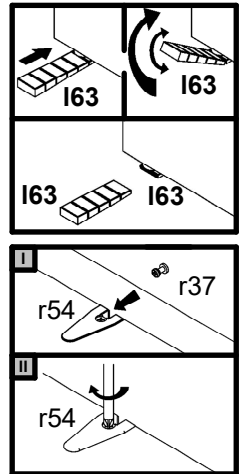
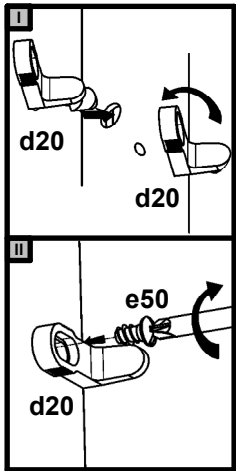
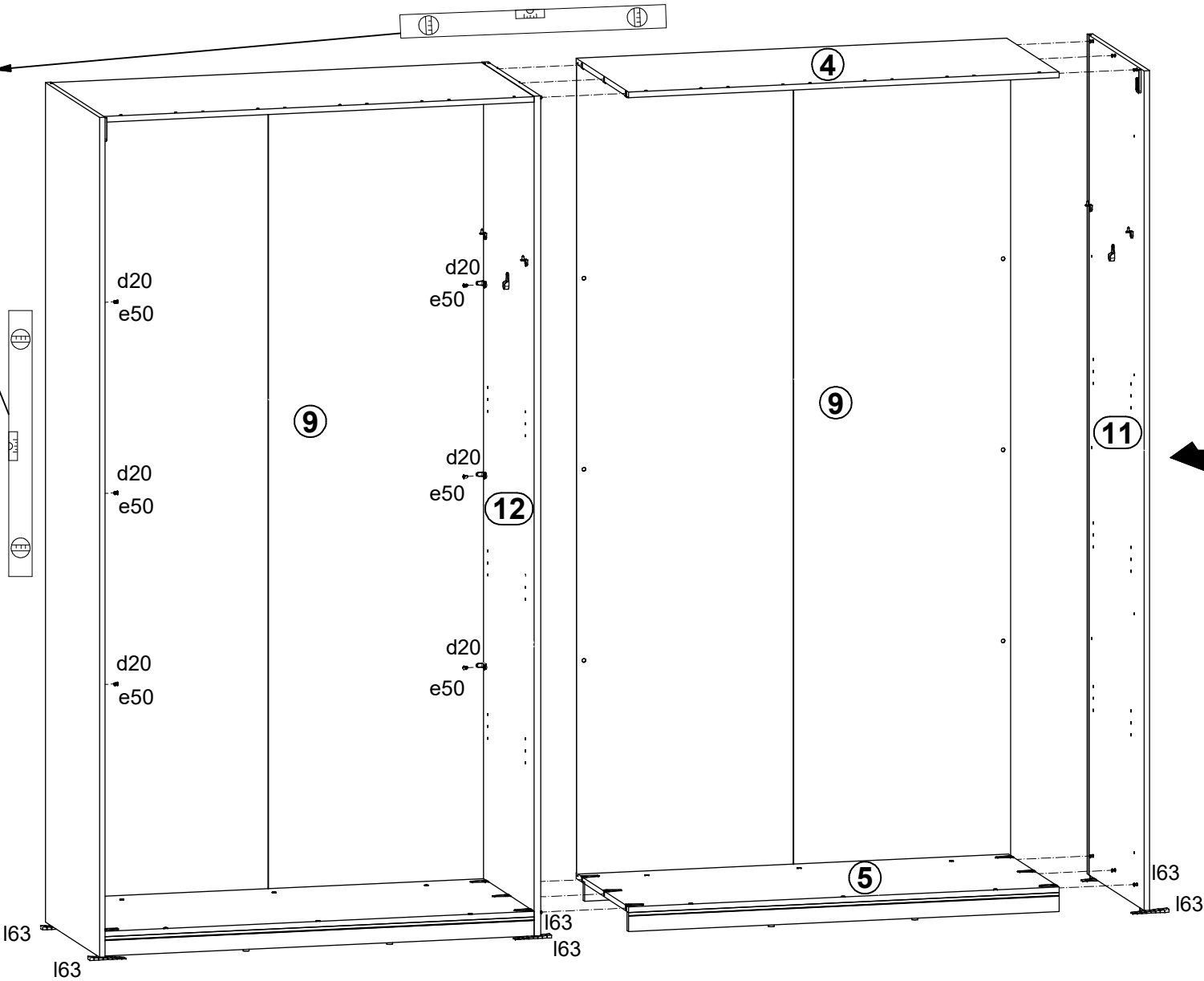
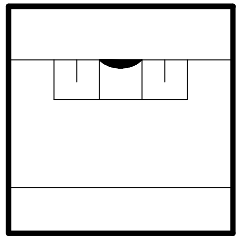

**5** §6



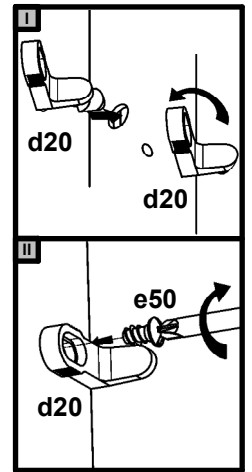
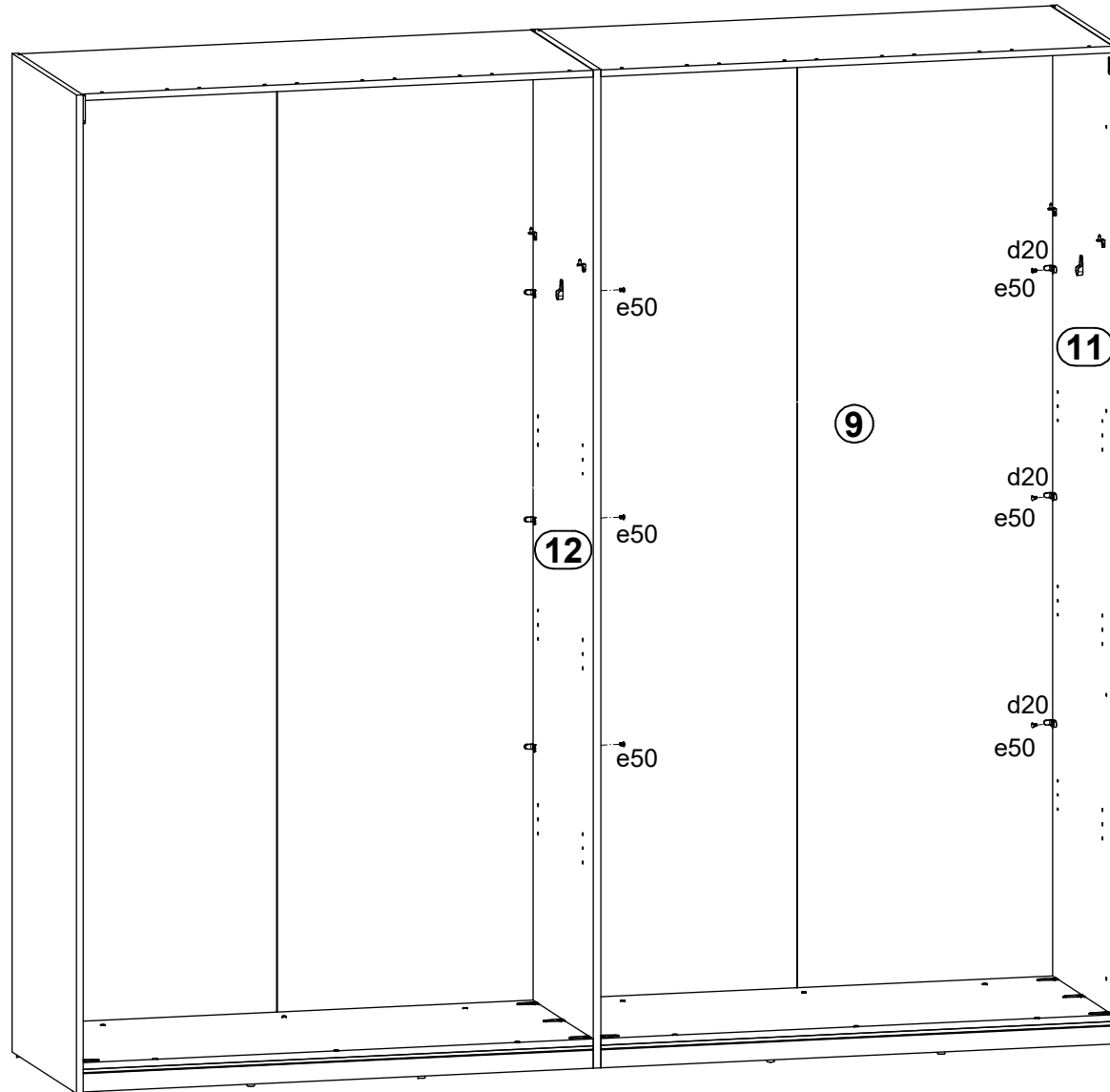



**6** 

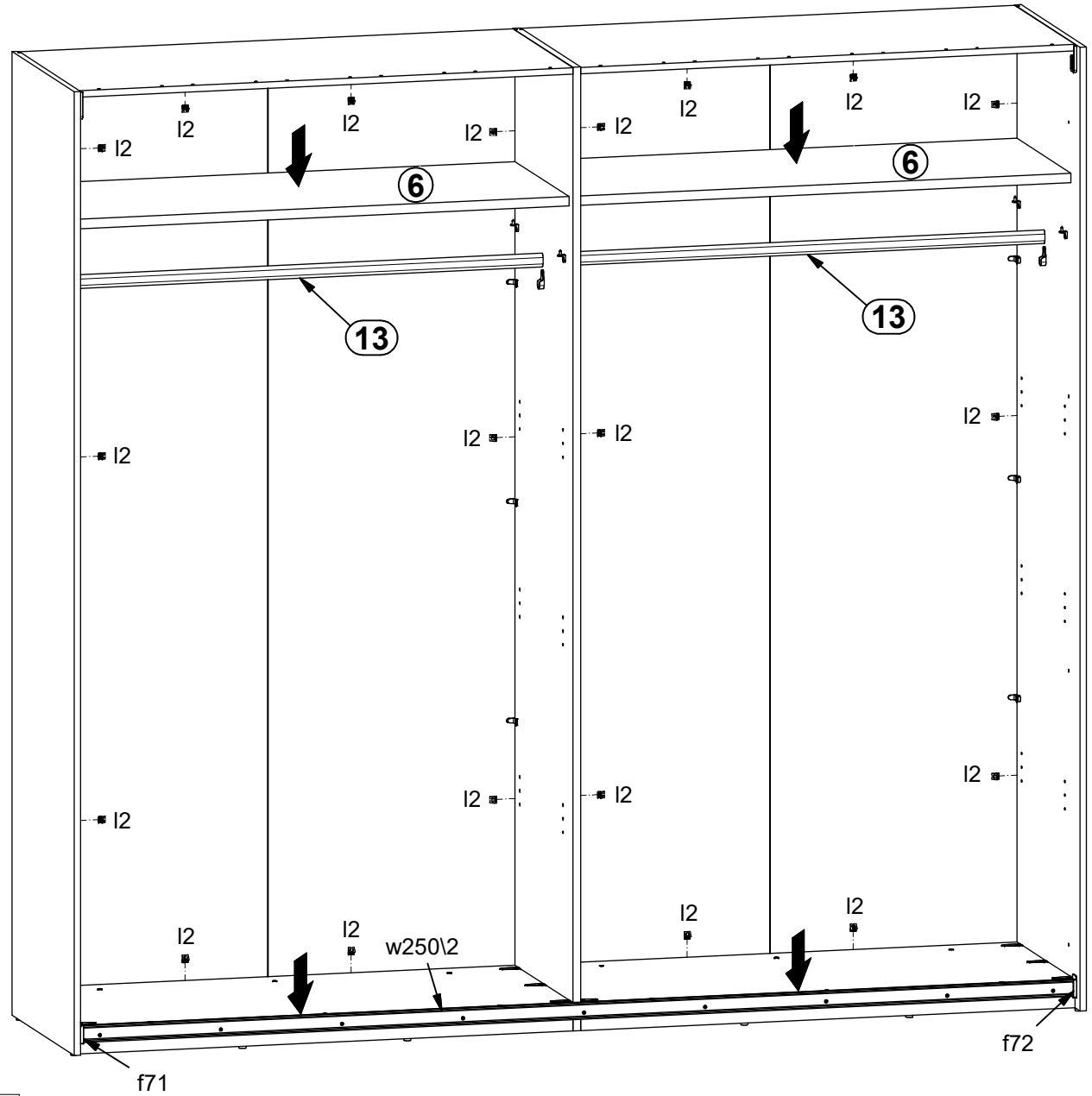
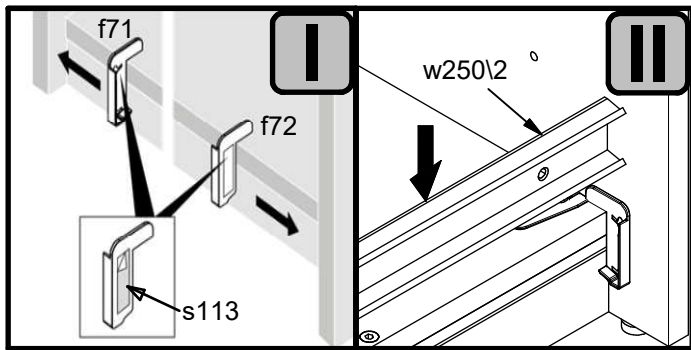
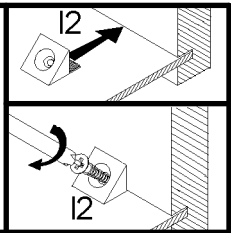
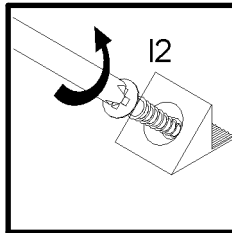
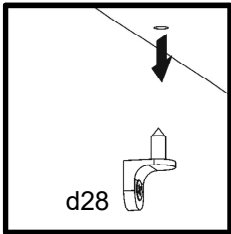
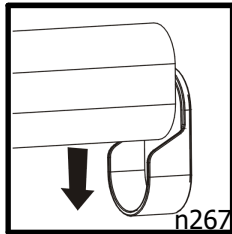
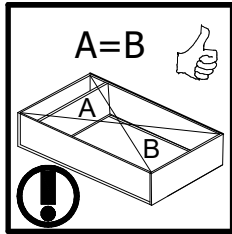

- 6x  **d20**
- 6x   $\varnothing 6,3 \times 10$  mm **e50**

**7** §6

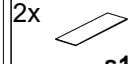
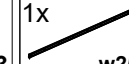

- 1x  f71
- 1x  f72
- 20x  I2
- 2x  s113
- 1x  w250\2



**8** §6

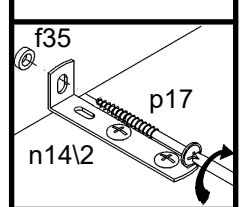
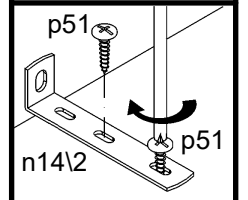
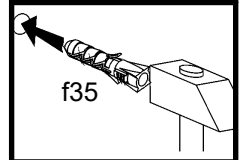
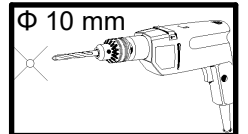
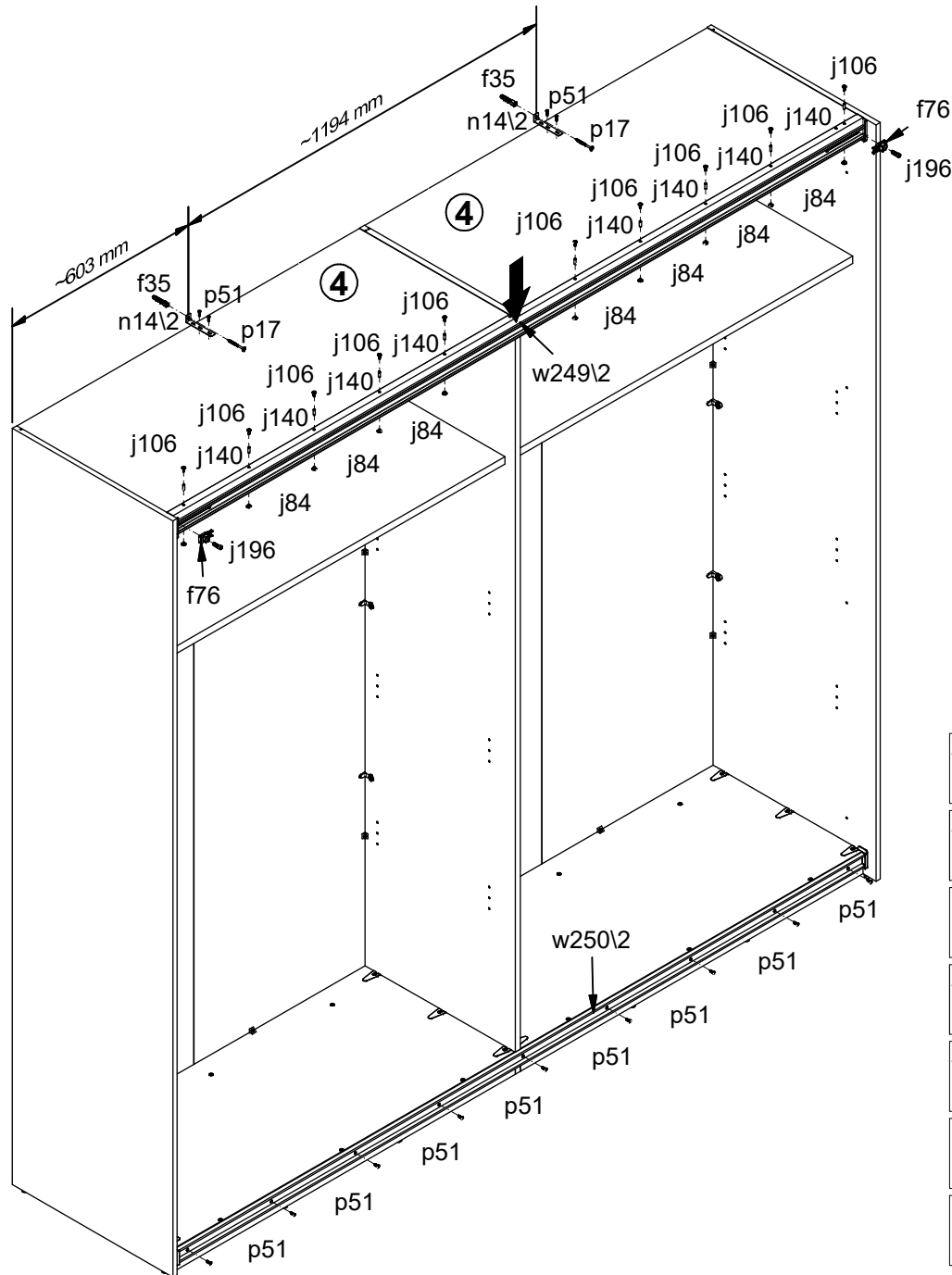
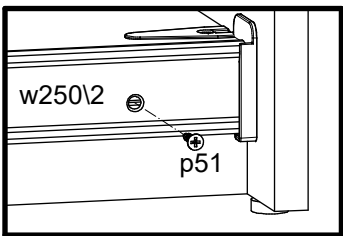
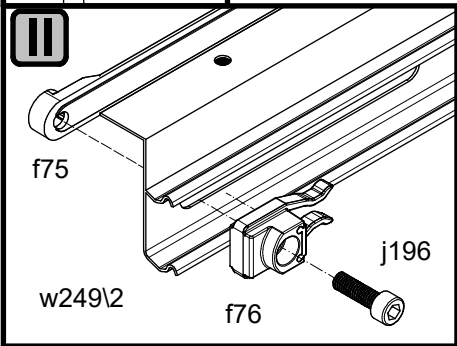
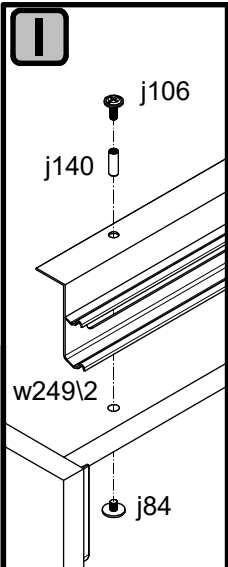

- |                                  |                                    |
|----------------------------------|------------------------------------|
| 2x<br>Ø10x50 mm<br><b>f35</b>    | 2x<br><b>f75</b>                   |
| 2x<br><b>f76</b>                 | 10x<br>M4x5 mm<br><b>j84</b>       |
| 10x<br>M4x10 mm<br><b>j106</b>   | 10x<br>Ø5x15 mm<br><b>j140</b>     |
| 2x<br><b>j196</b>                | 2x<br>86x21x15/1,5<br><b>n14\2</b> |
| 2x<br>Ø5x60 mm<br><b>p17</b>     | 13<br>Ø3,5x15 mm<br><b>p51</b>     |
| 12x<br><b>s1</b>                 | 14x<br>Ø14x0,5 mm<br><b>s59</b>    |
| 1x<br>L-2368 mm<br><b>w249\2</b> | 1x<br>5 mm<br><b>z17</b>           |

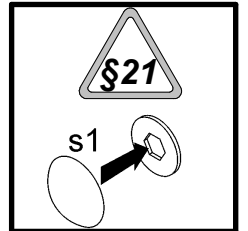

9 §2 §6

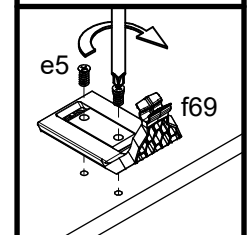
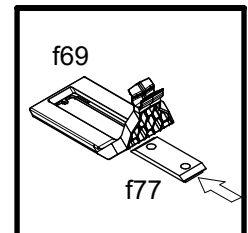
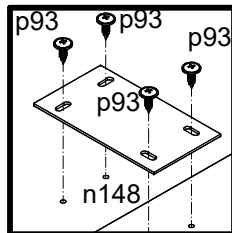
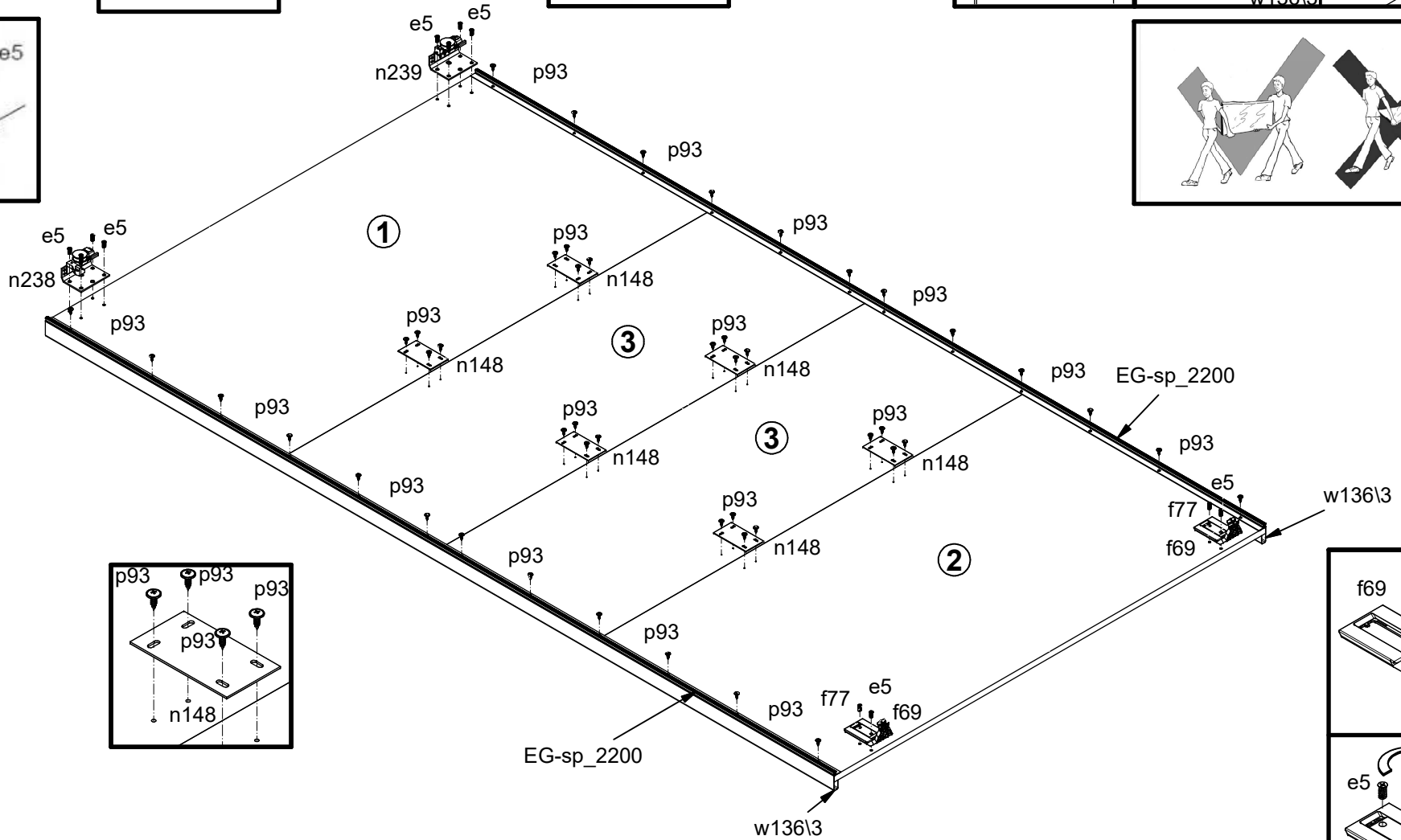
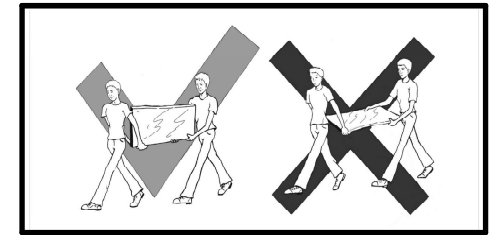
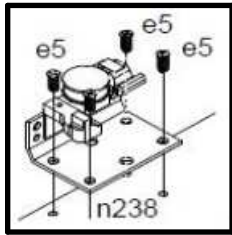
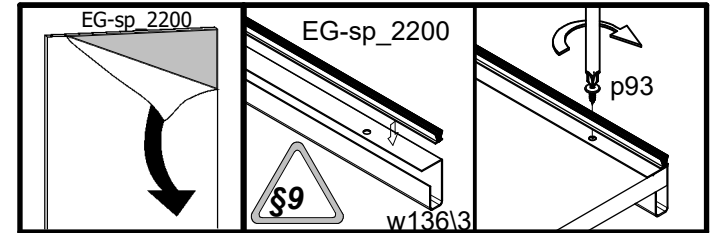
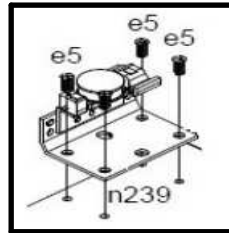
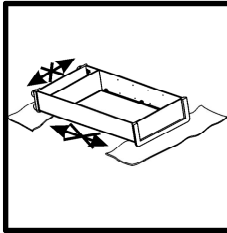

- 2x EG-sp\_2200
- 12x Ø6,3x13 mm e5
- 2x f69
- 2x f77
- 6x 90x50x1,5 mm n148
- 1x n238
- 1x n239
- 48x Ø4x13 mm p93
- 2x 2200 mm w136\3

10 §2 §6

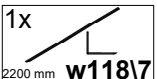
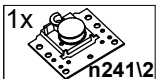
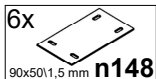
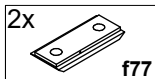
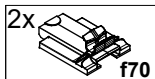
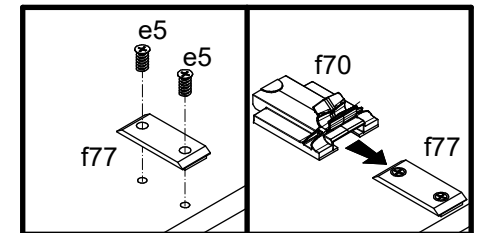
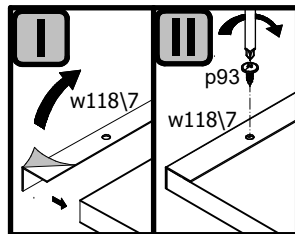
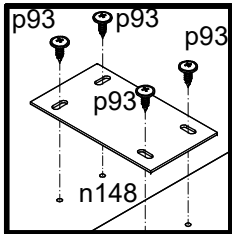
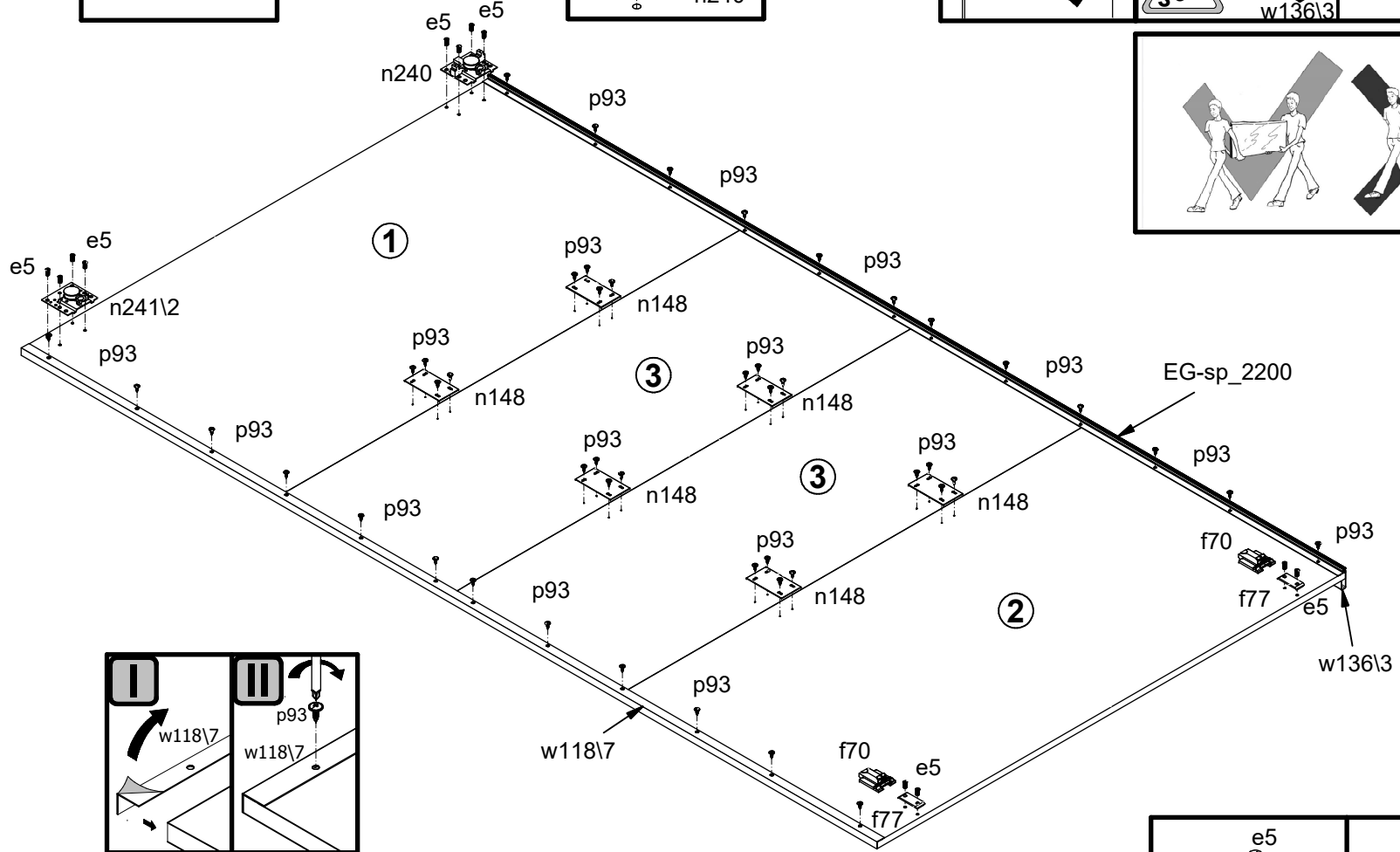
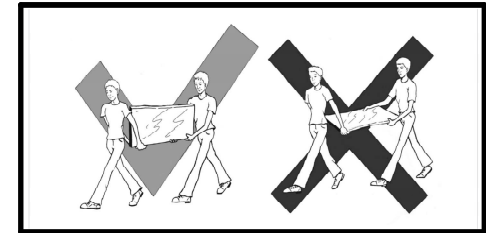
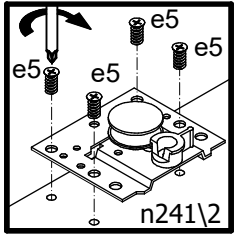
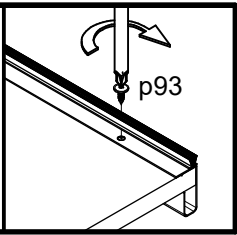
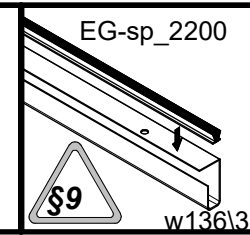
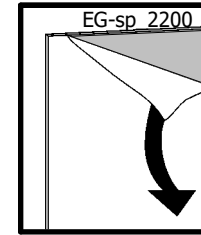
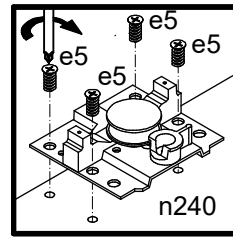
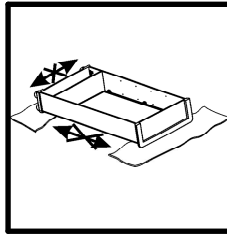

# 11

§6

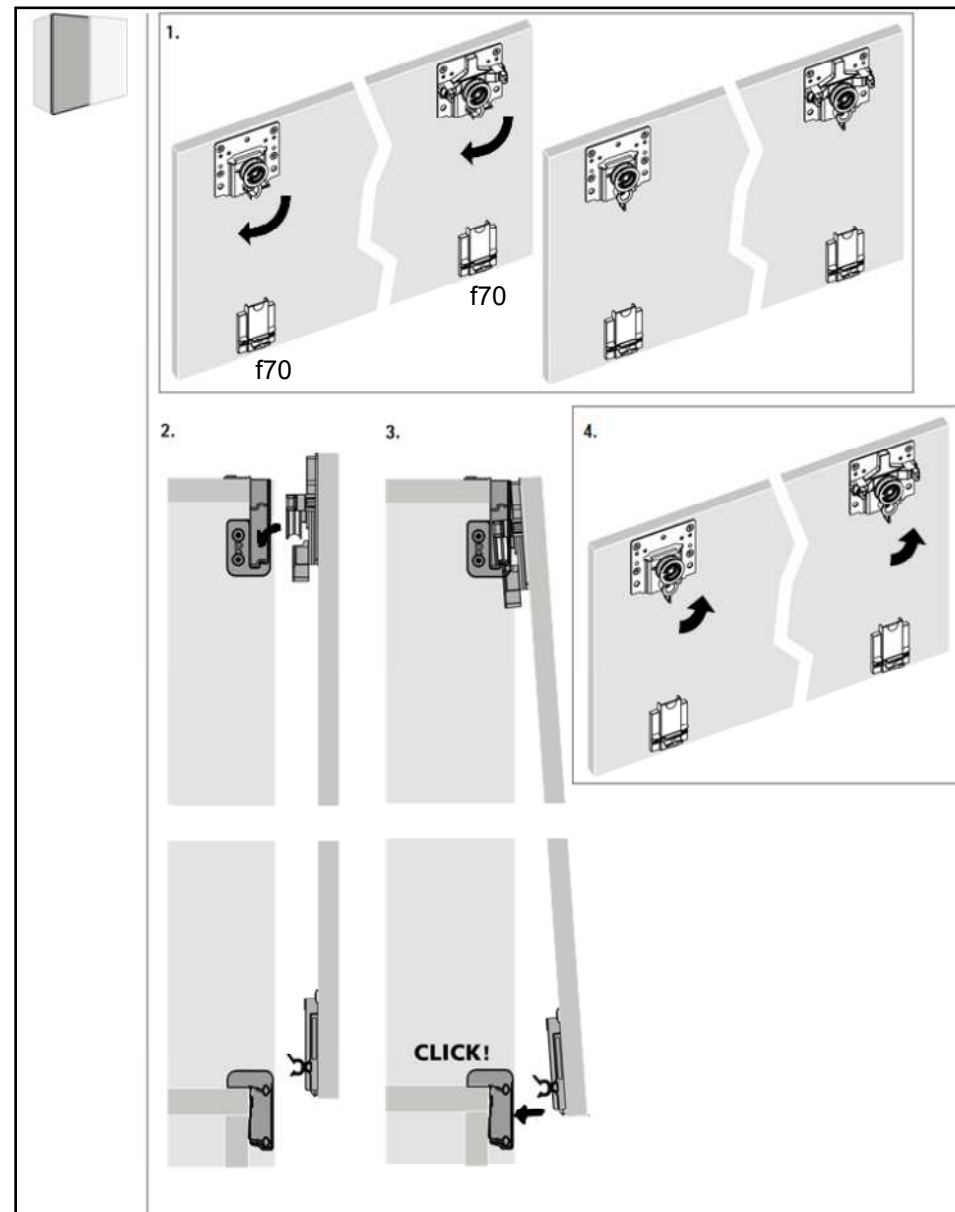
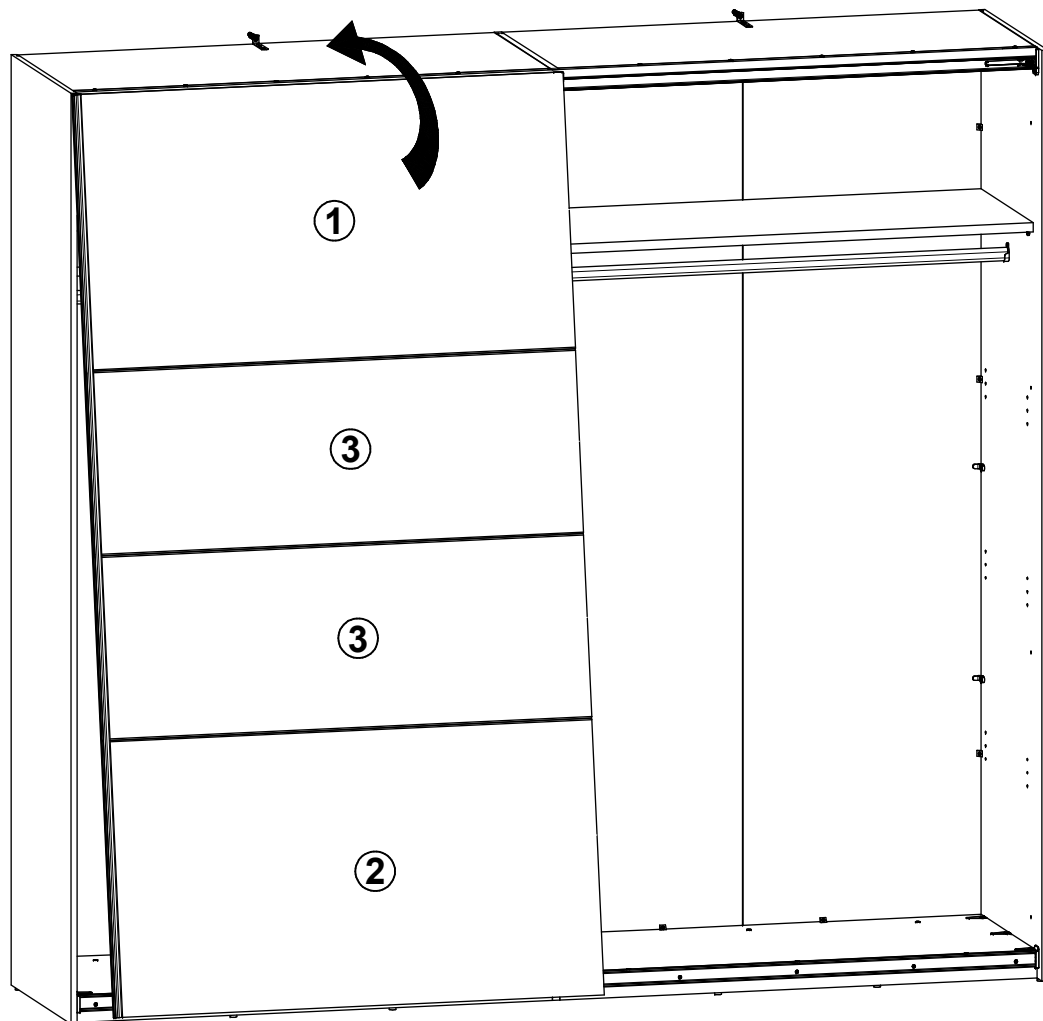

# 12

§6

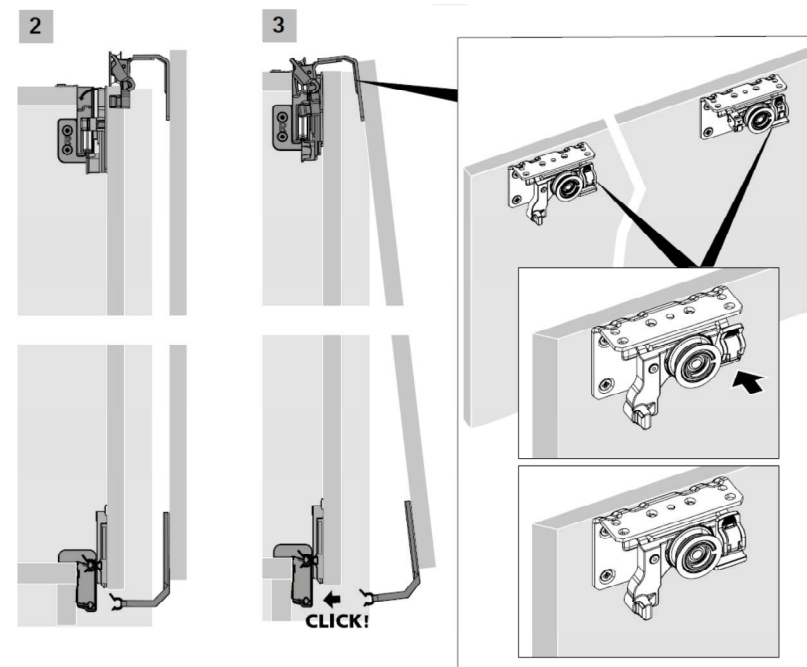
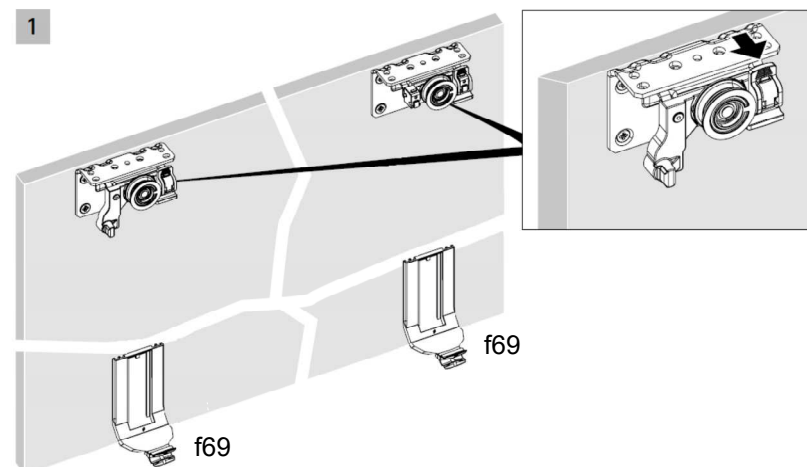
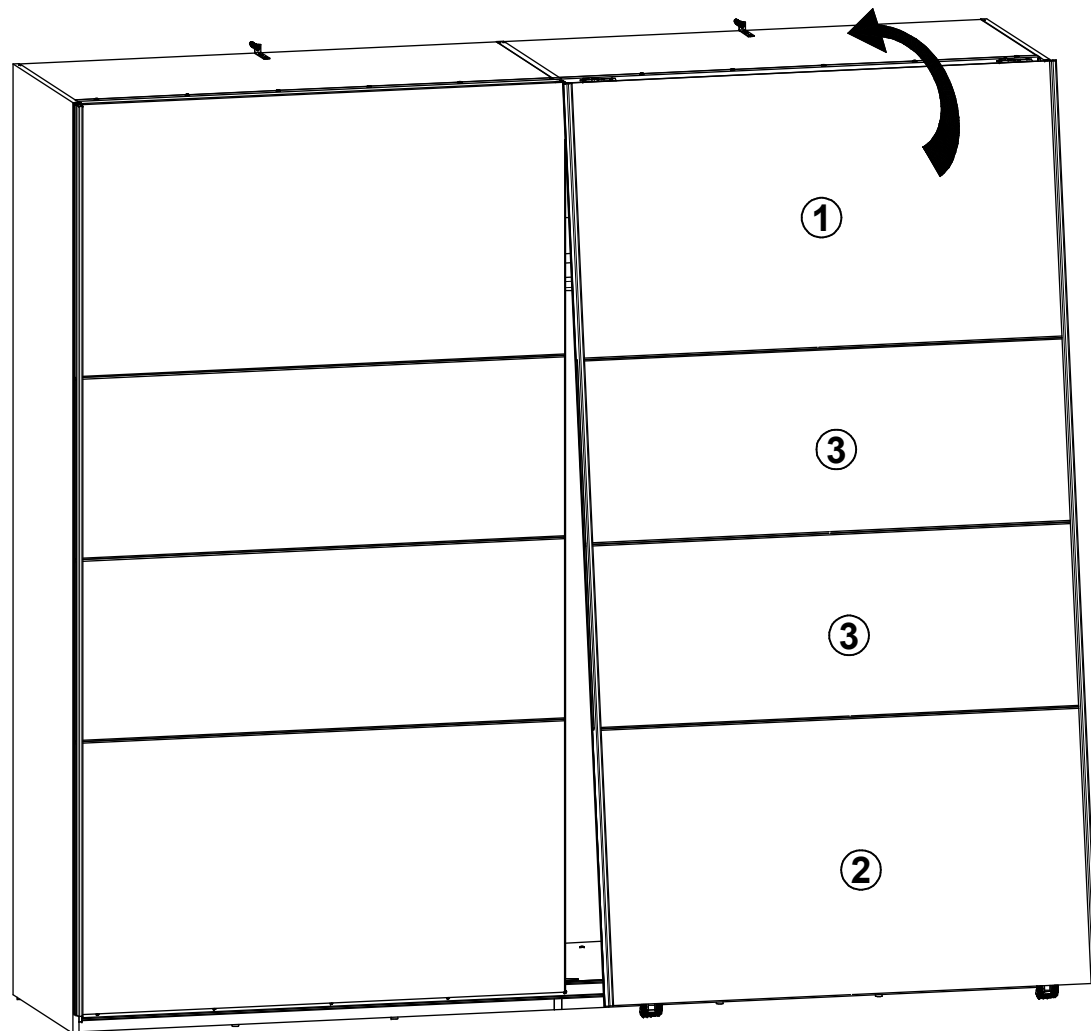

13

