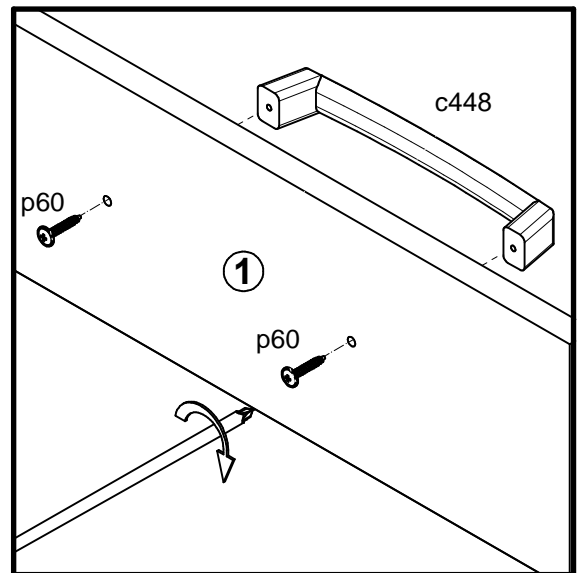
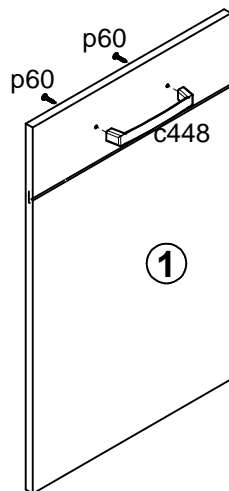
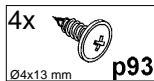
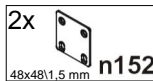
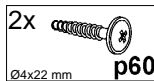
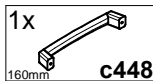
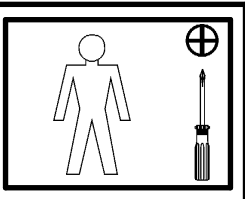
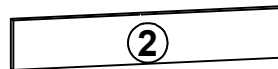
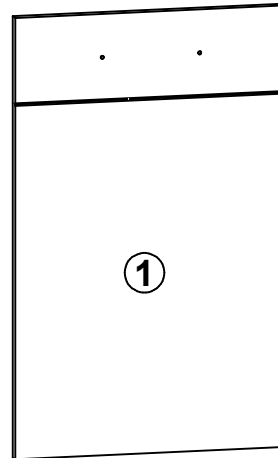
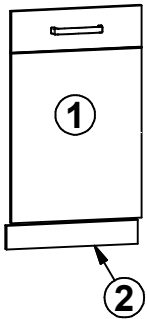

A**SEMI LINE****K30-DM-45/72**

A	B	C	D
1	K30-0024	446	713
2	K30-4025	449	80

**2**