

A**SEMI LINE****K30-DM-60/72**

| A | B | C | D |
|---|----------|-----|-----|
| 1 | K30-0025 | 596 | 713 |
| 2 | K30-4024 | 599 | 80 |

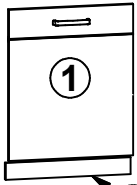

②

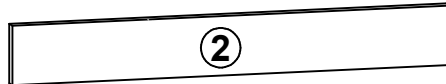
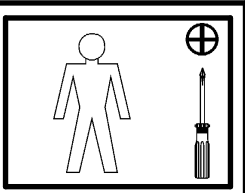

②

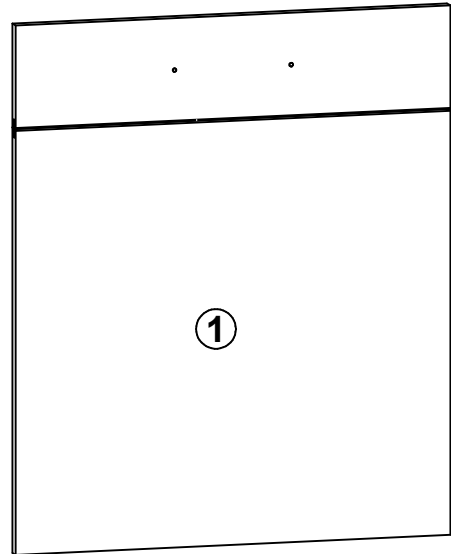

①

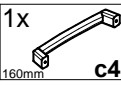

c448

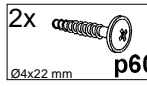

p60

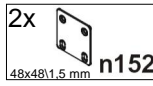

n152

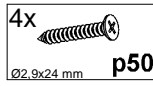

p50

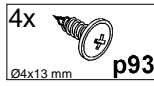

p93

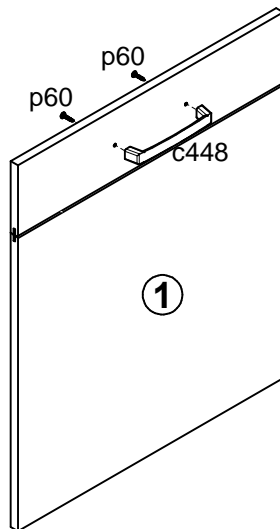
1

①

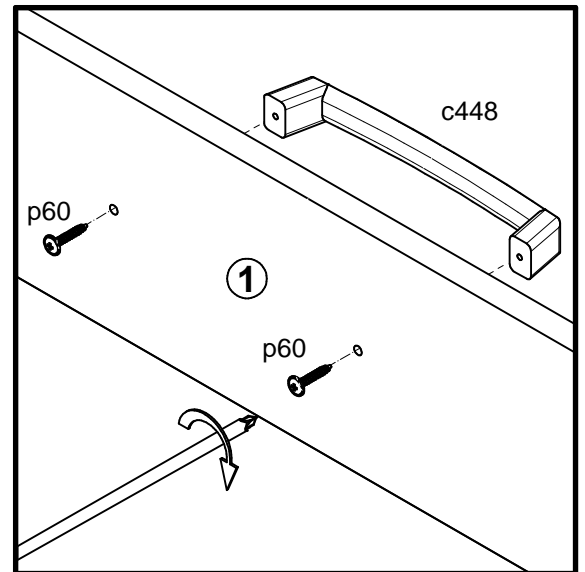

①

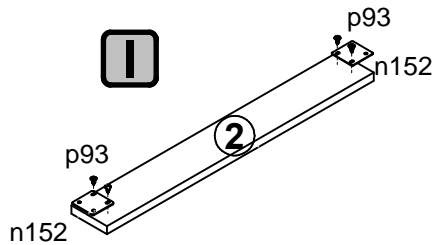
2

②

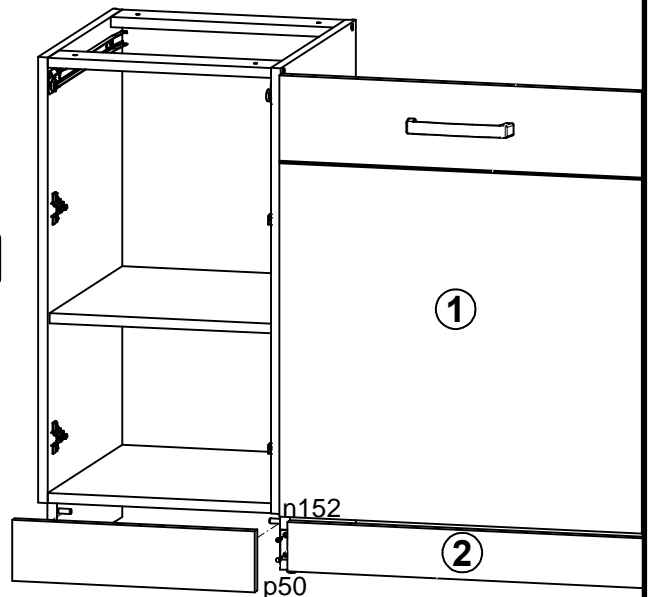

①

②

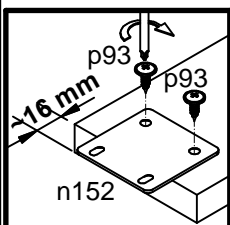

n152

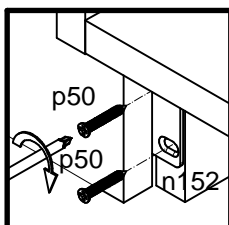

p50

n152