

Modellname: **ALASKA**
Nazwa modelu:

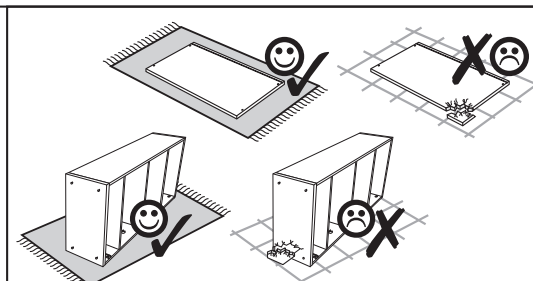

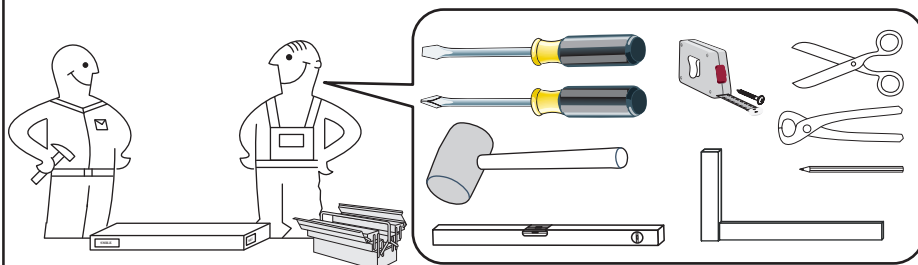

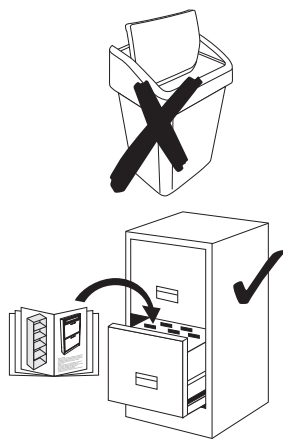

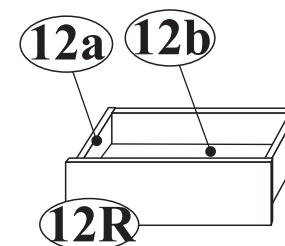
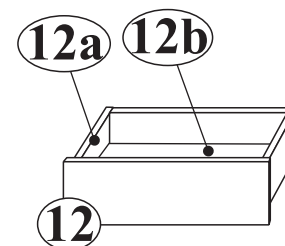
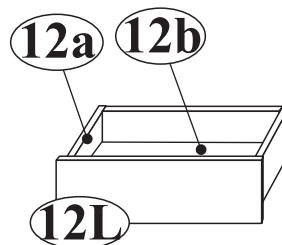
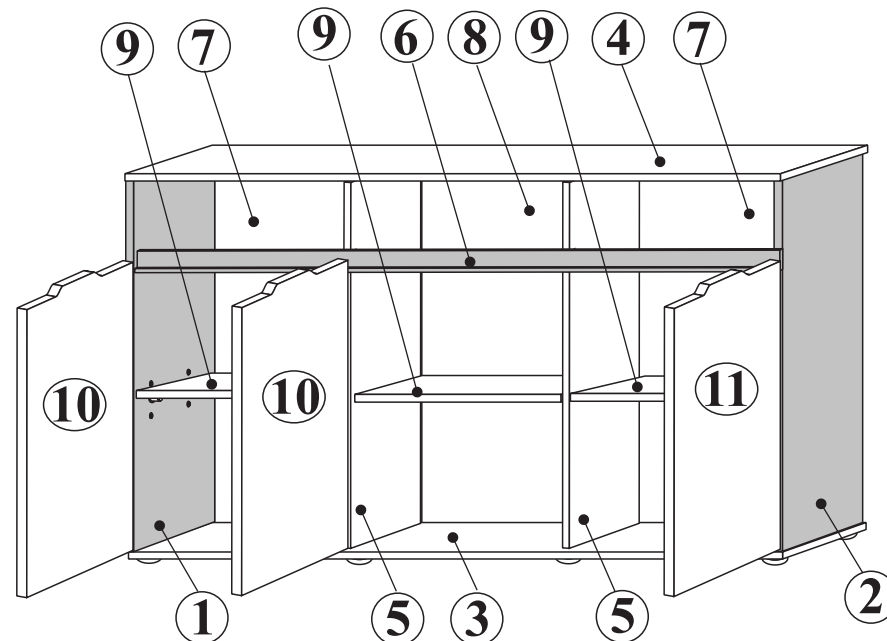
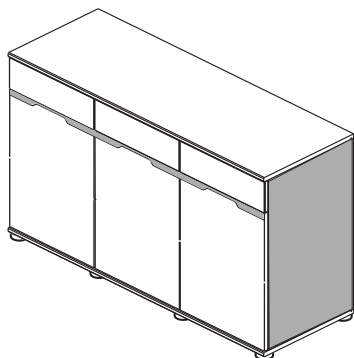

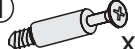

Modellreihe: **P9 -- AS**
Numer modelu:

Type: **K6**
Typ:



Blatt Nr **1** von: **7**
Strona z:



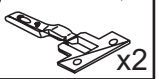

NR 1

- L1**  x1
- C2**  x8
- M1**  x16
- T1**  x16
- K3**  x2
- B1**  ϕ 8x28 x20
- W1**  x12
- S3**  3,5x13 x4
- F1**  x6+6
- S4**  3,0x20 x12
- J23**  x24



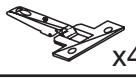

NR 2

- Y2**  ϕ 26 x2
- Y5**  H0 x2
- S8**  4x13 mm x4

NR 3

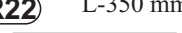
- Y0**  ϕ 26 x4
- Y5**  H0 x4
- S8**  4x13 mm x8

NR 4

- R22**  L-350 mm x3L/3R
- E1**  6x11 x6
- E2**  6x8 x12
- S3**  3,5x13 x6
- P3**  3,0x13 x12

NR 5

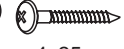
- F10**  x8
- P4**  4x25 x8



1

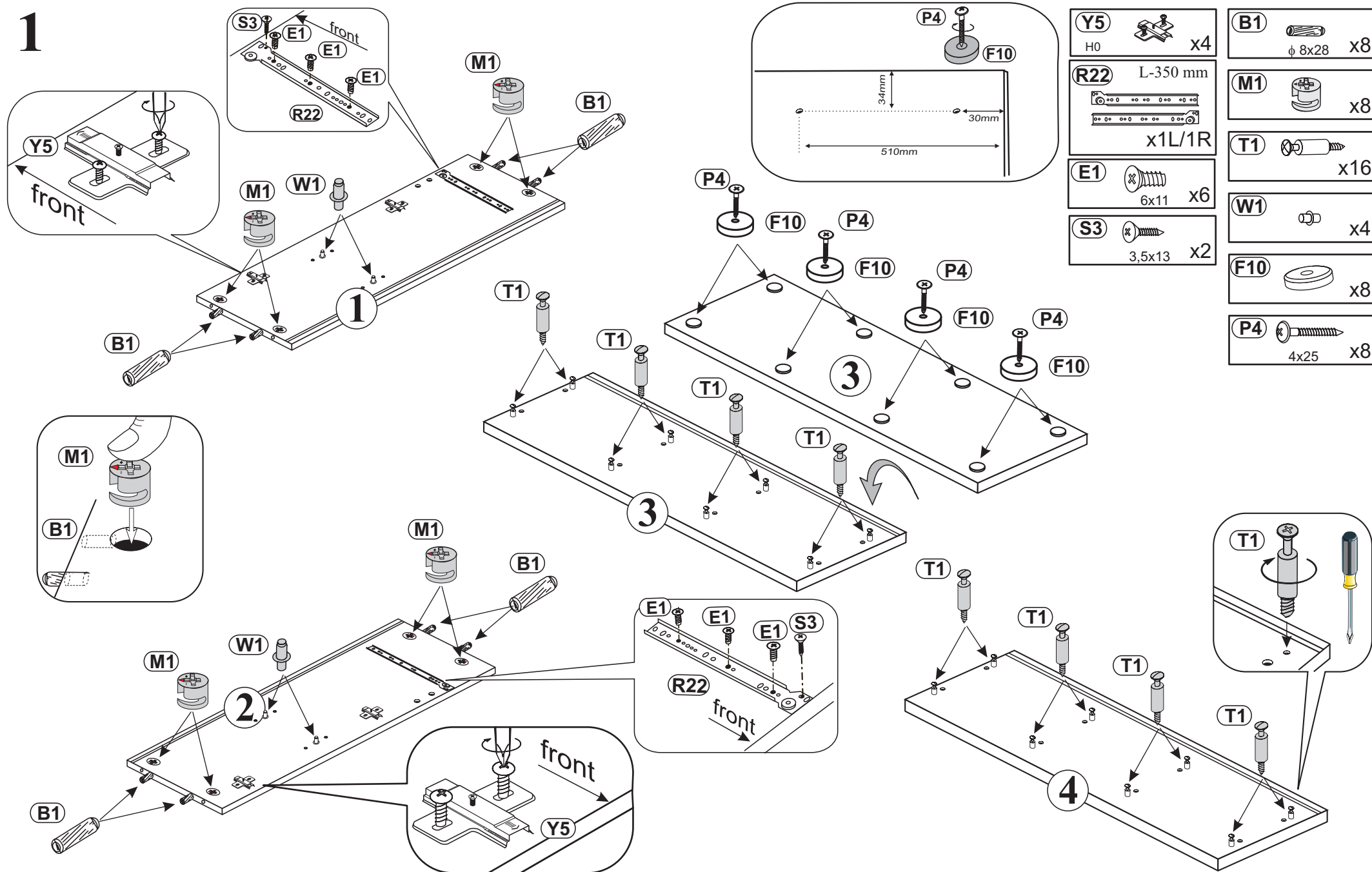

Y5 H0 x4

R22 L-350 mm x1L/1R

E1 6x11 x6

S3 3,5x13 x2

B1 ϕ 8x28 x8

M1 x8

T1 x16

W1 x4

F10 x8

P4 4x25 x8

2

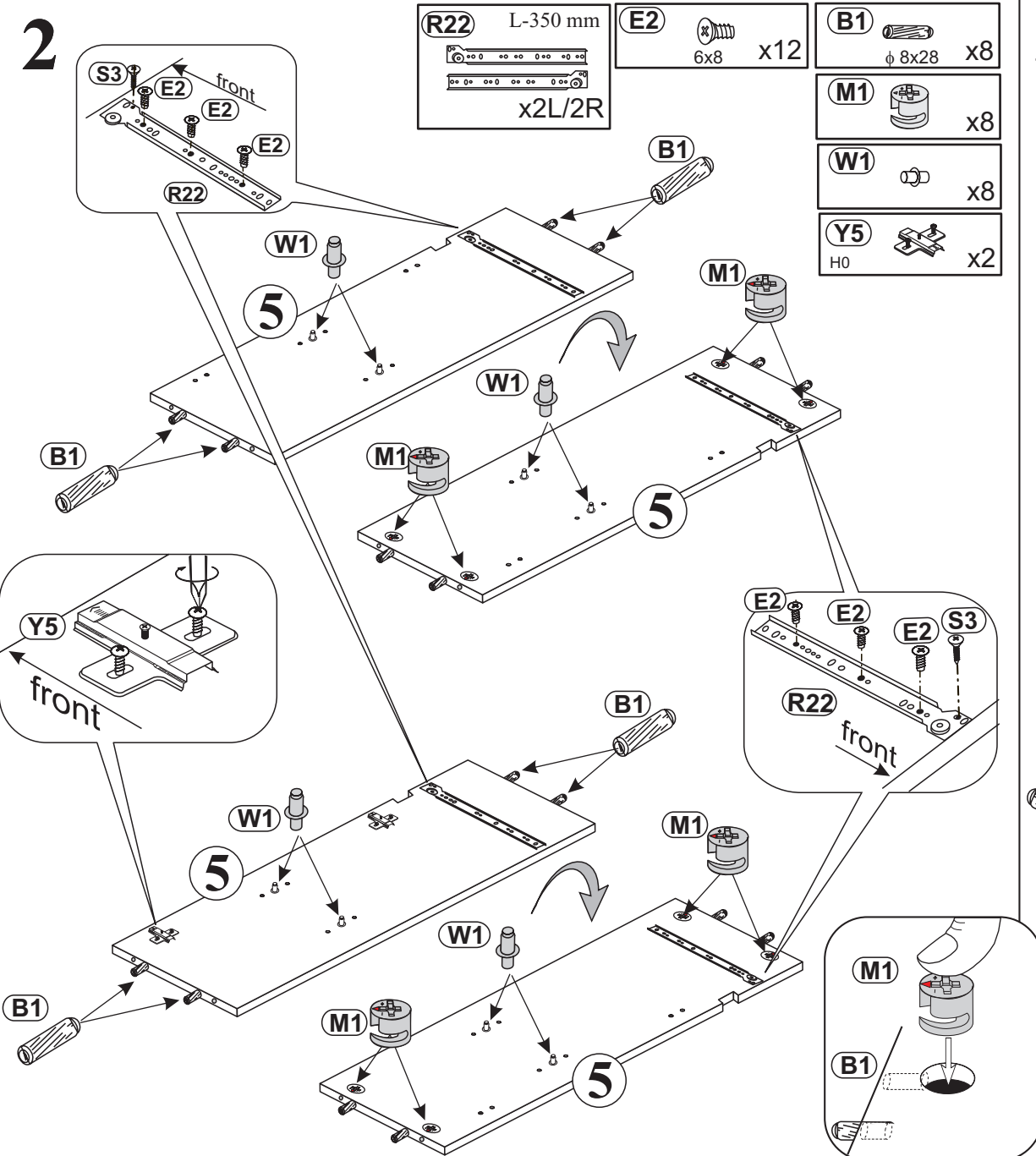

3

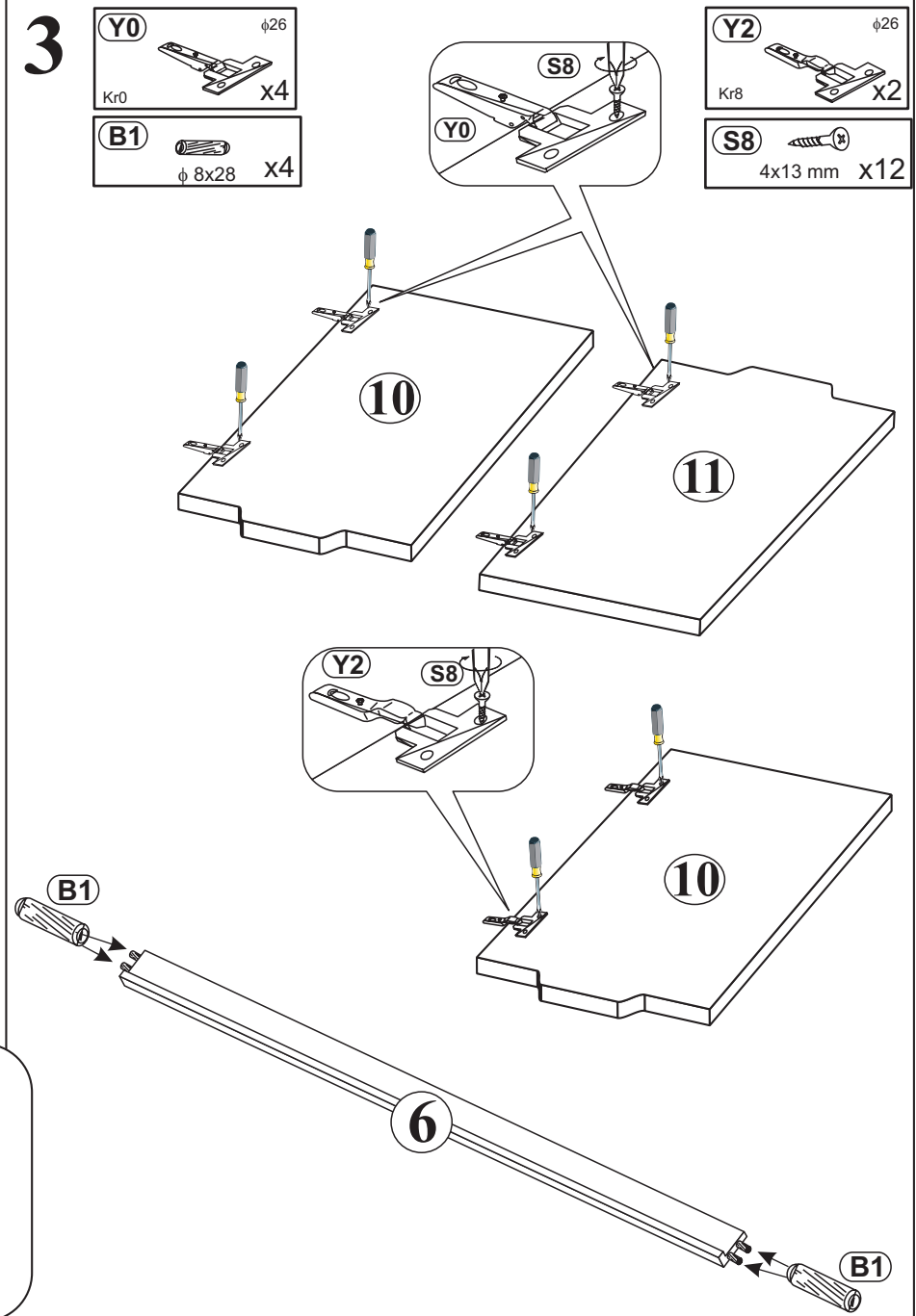

4

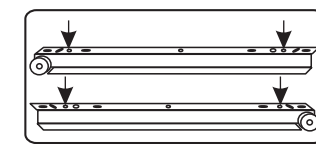
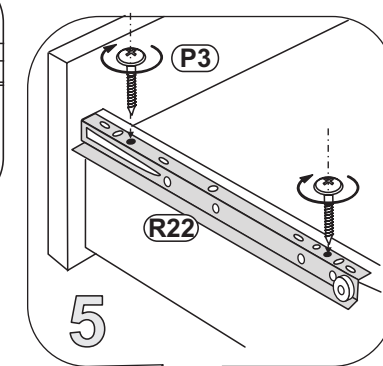
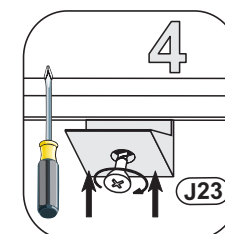
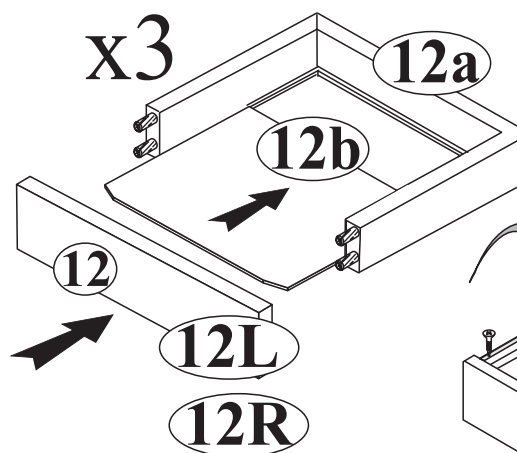
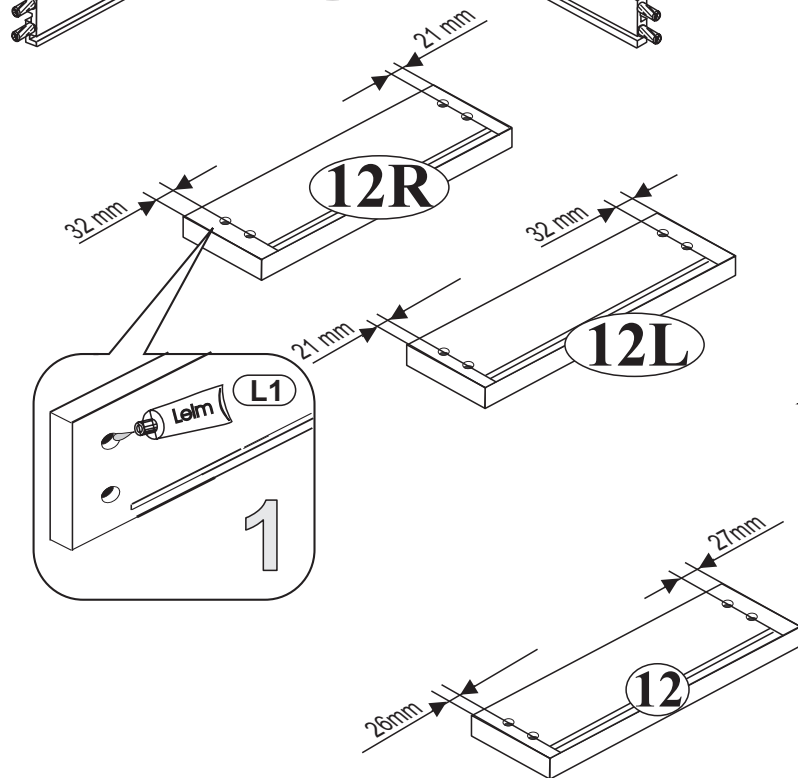
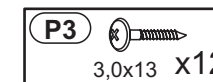
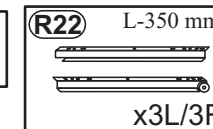
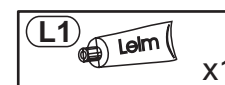
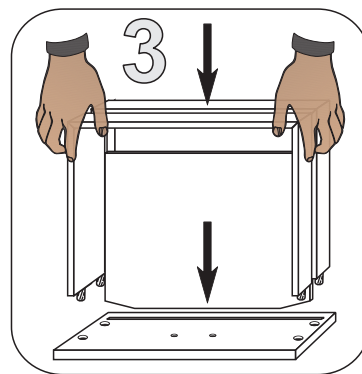
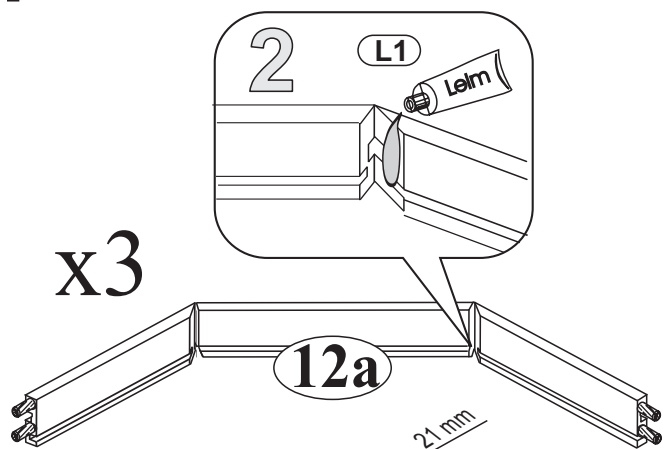

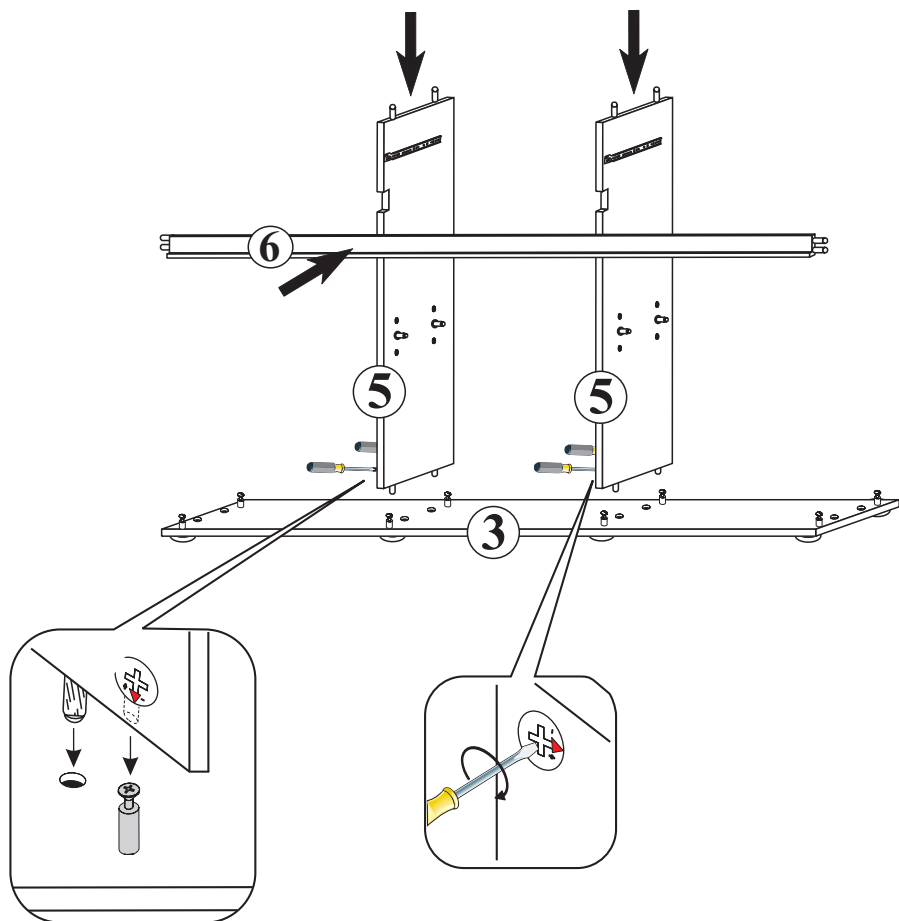

5

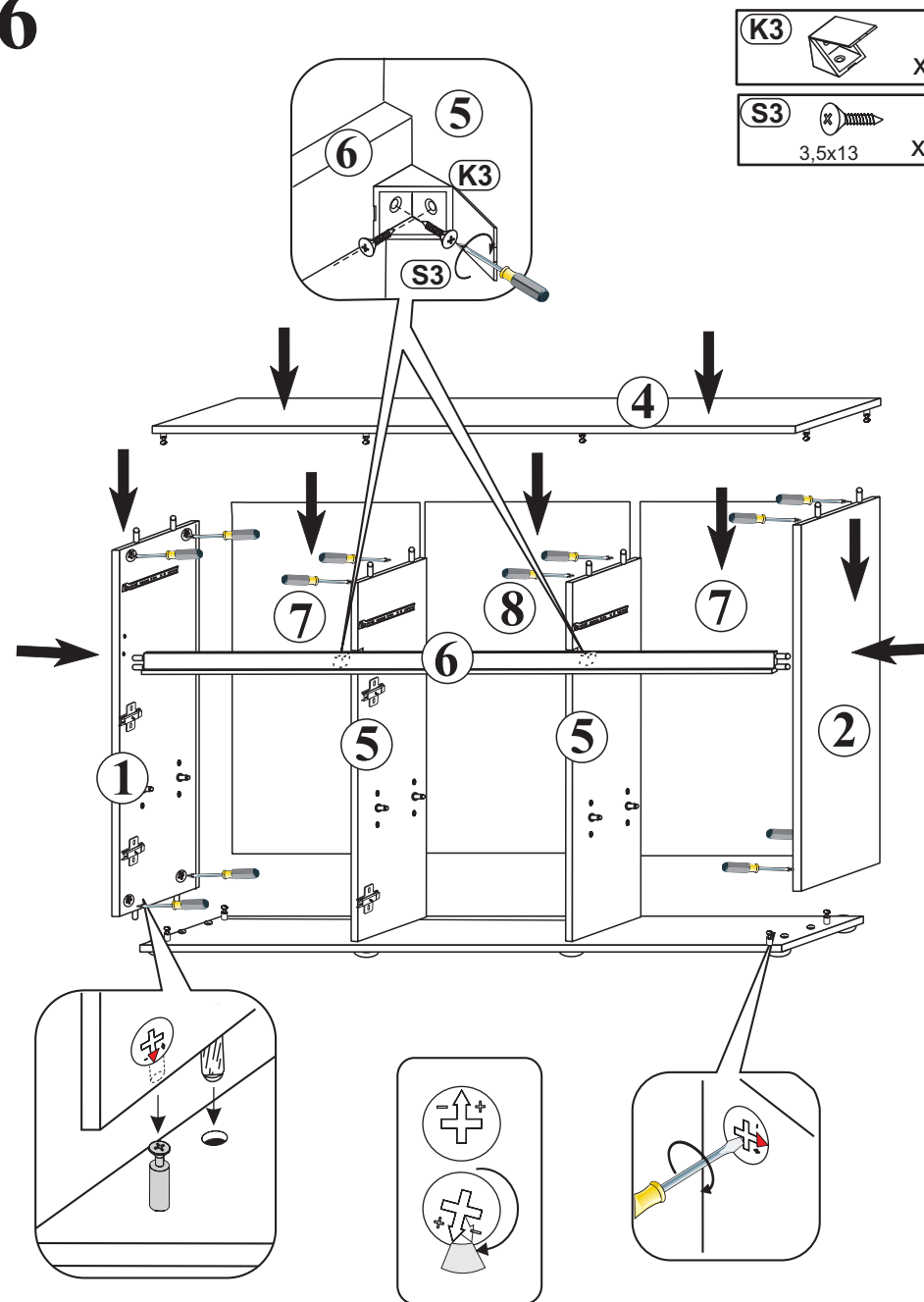

6



7

- F1**  x12
- S4**  3,0x20 x12
- J23**  x18

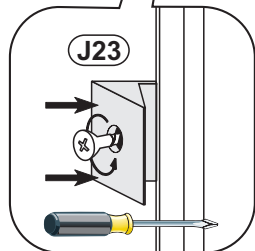
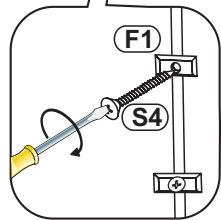
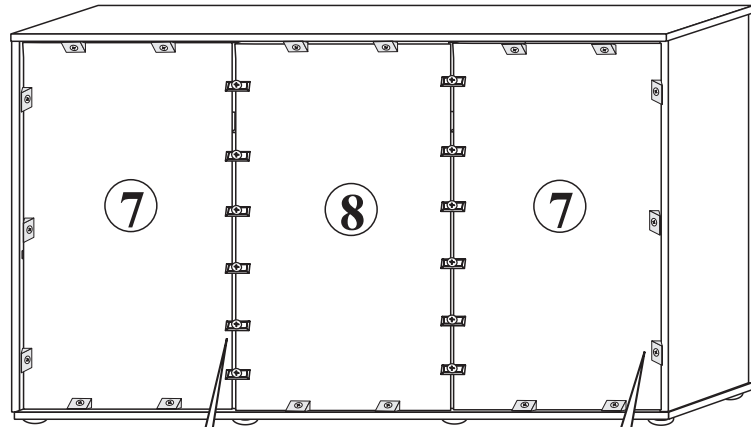

8

