

Modellname: **RUBI**
 Nazwa modelu:

Modellreihe: **P6--RB**
 Numer modelu:

Type: **30**
 Typ:

Blatt Nr **1** von: **7**
 Strona z:

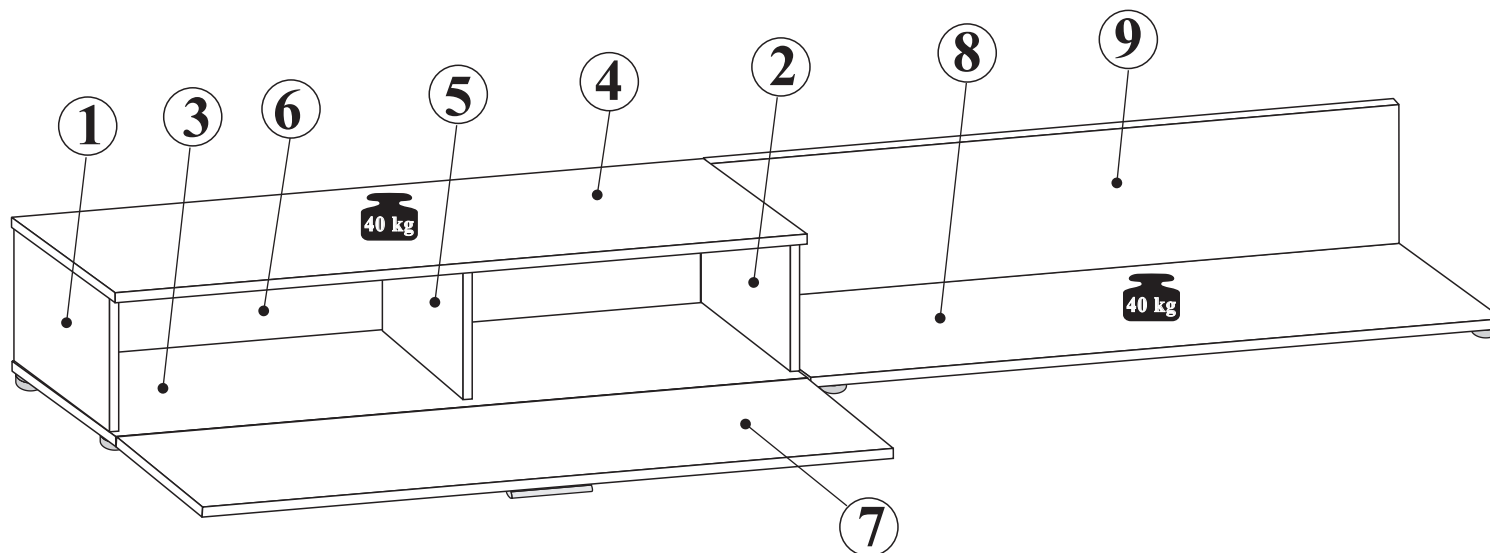
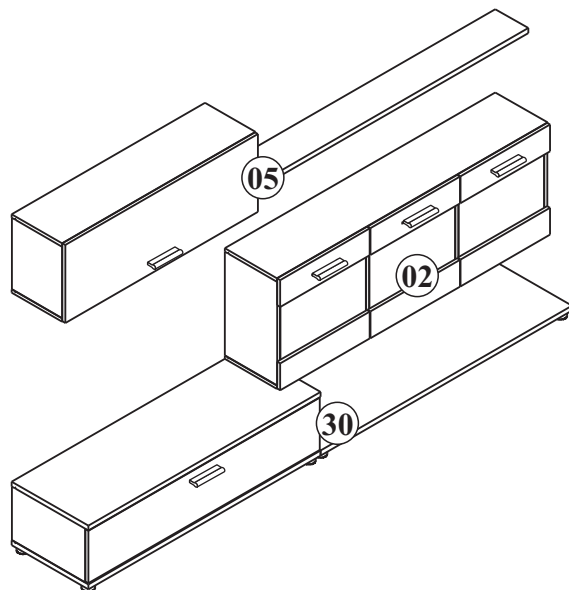

| NO | Dim. | | Col.-No | Qty |
|----|------|-----|---------|-----|
| 1 | 240 | 379 | 3 | 1 |
| 2 | 240 | 379 | 3 | 1 |
| 3 | 1200 | 396 | 3 | 1 |
| 4 | 1200 | 396 | 3 | 1 |
| 5 | 240 | 359 | 3 | 1 |
| 6 | 1177 | 249 | 3 | 1 |
| 7 | 1196 | 234 | 3 | 1 |
| 8 | 1300 | 396 | 3 | 1 |
| 9 | 1299 | 262 | 3 | 1 |

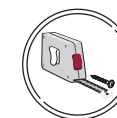
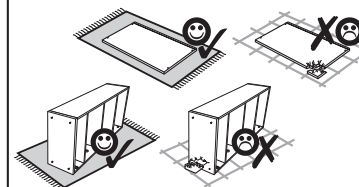
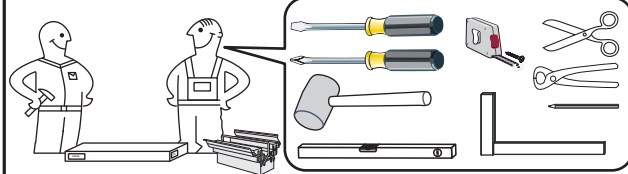
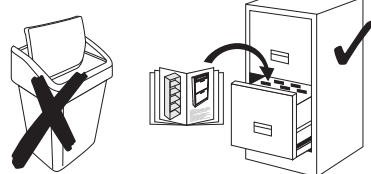

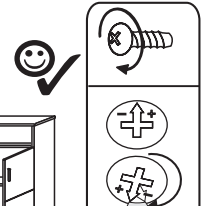
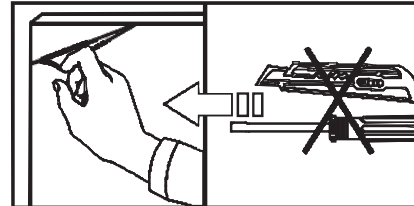
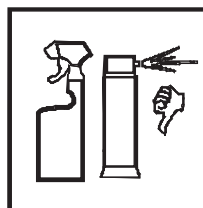
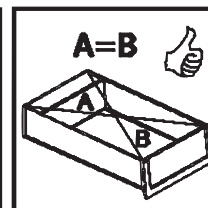
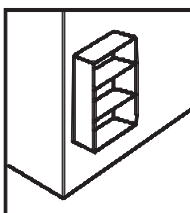
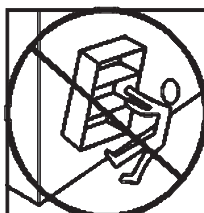
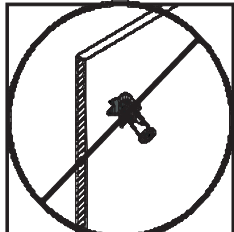
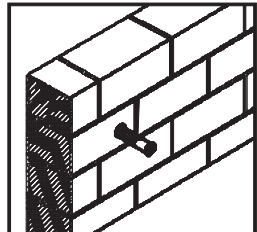
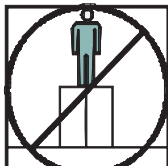
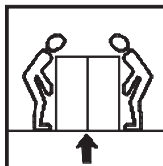
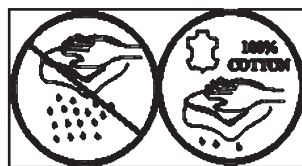
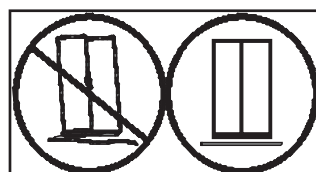
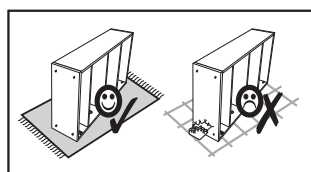
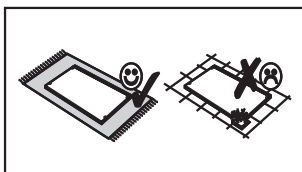
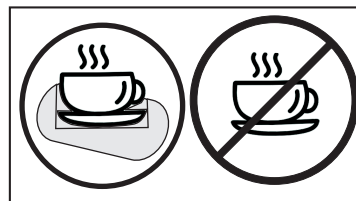
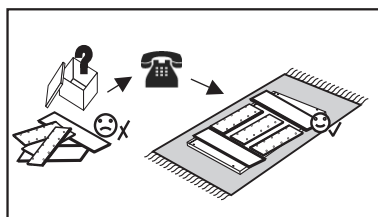
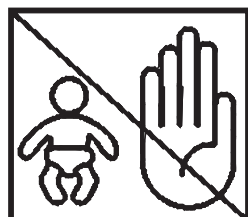
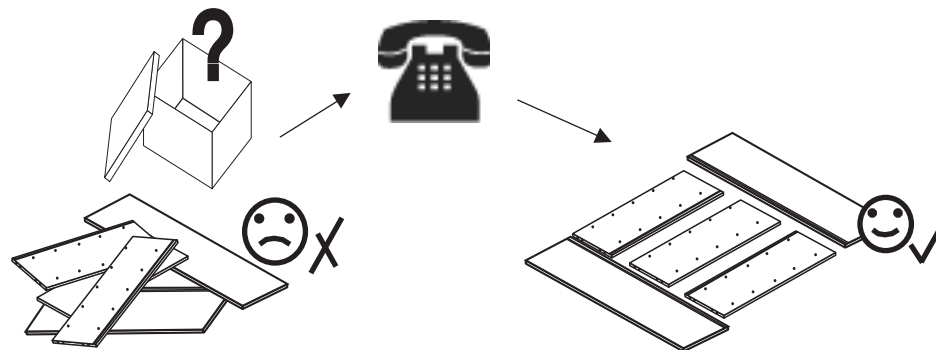

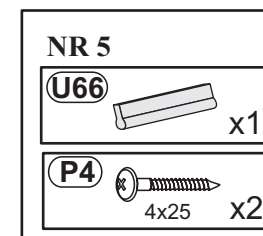
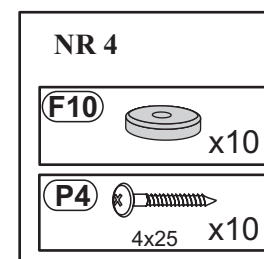
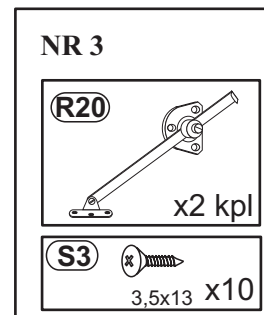
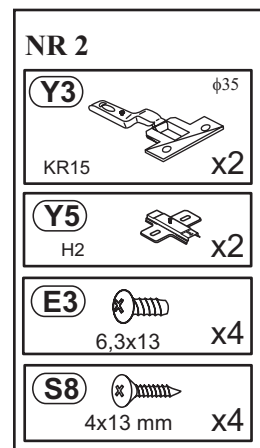
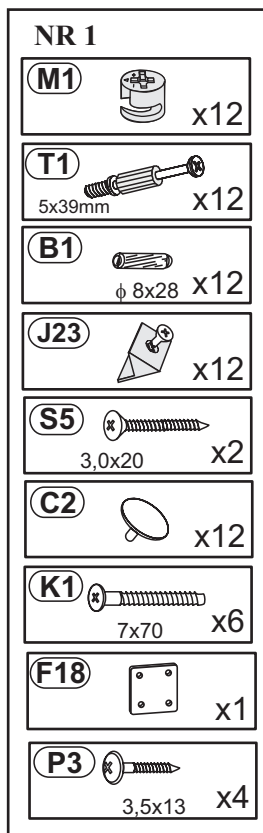

1

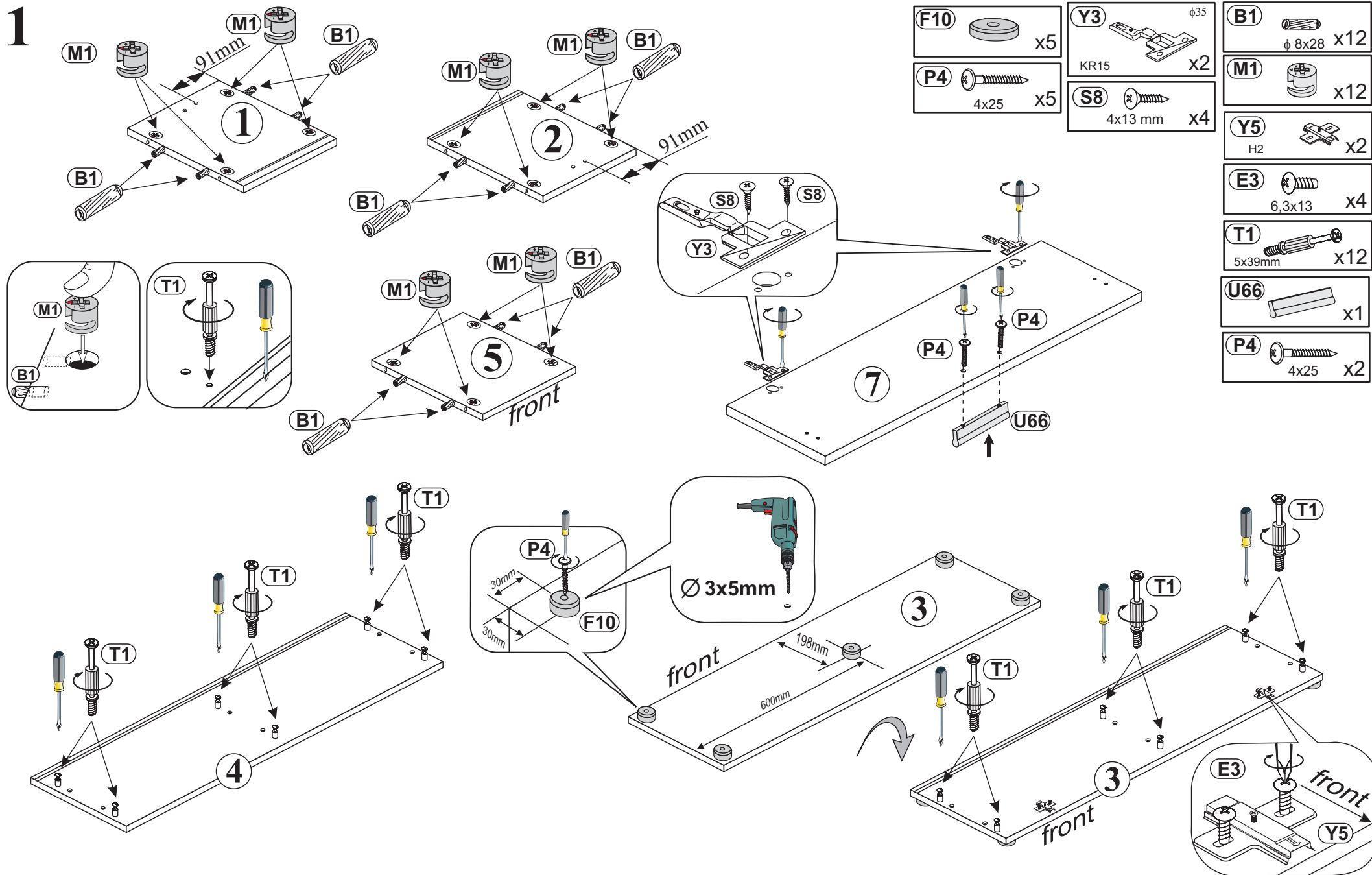

2

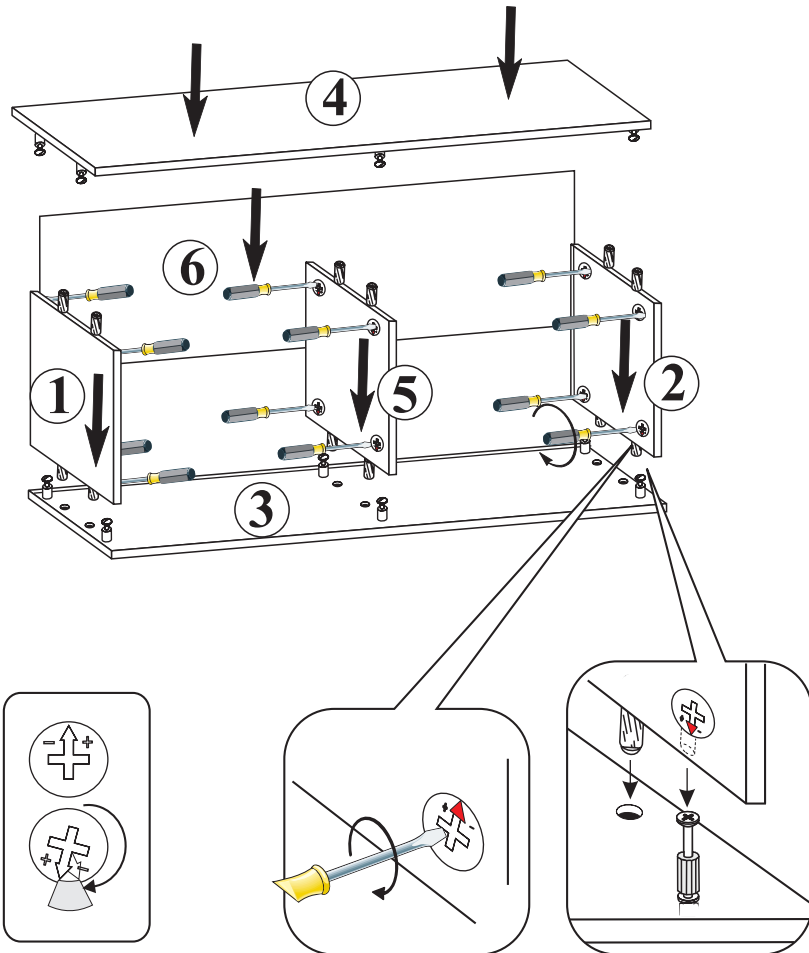

3

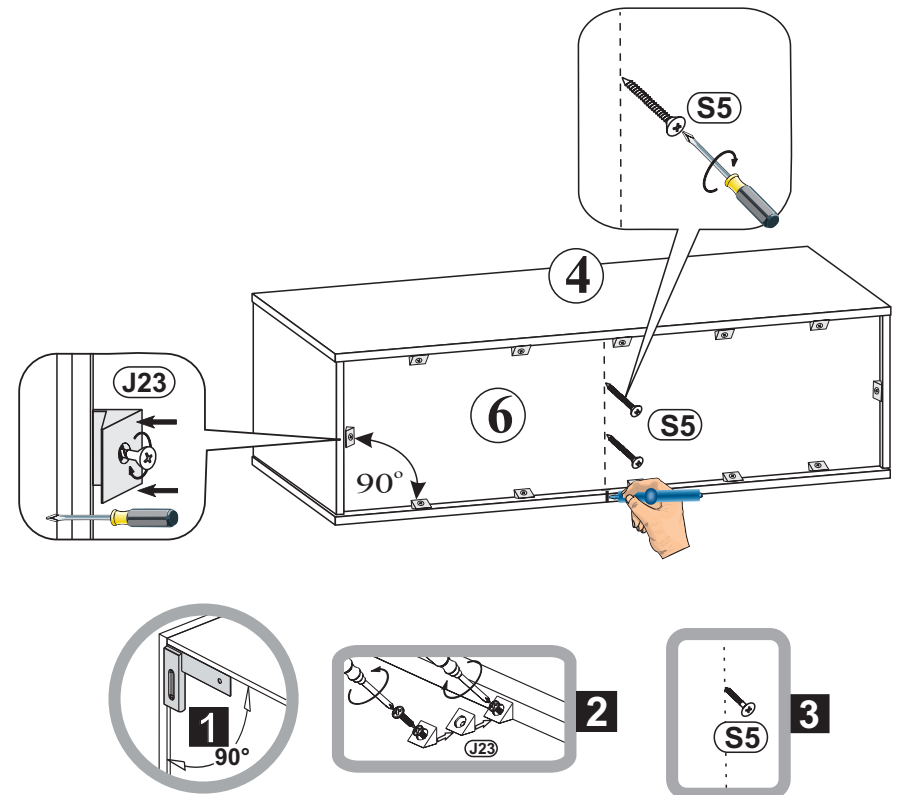
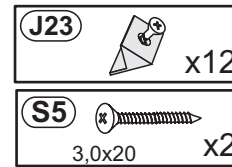

4

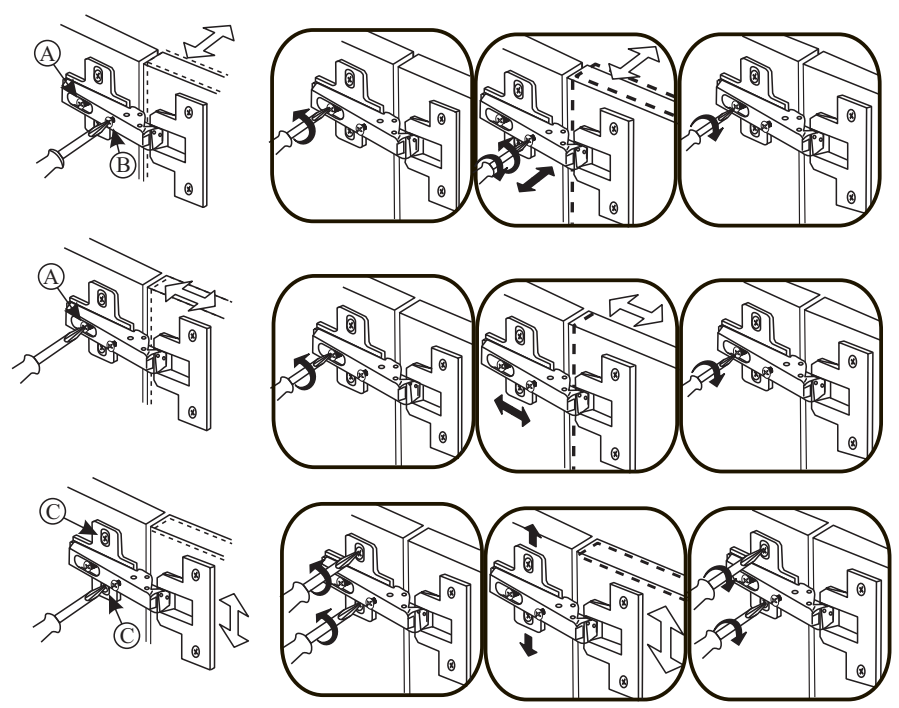
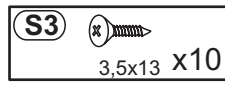
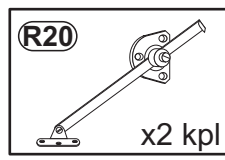
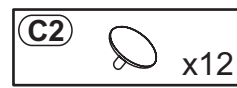
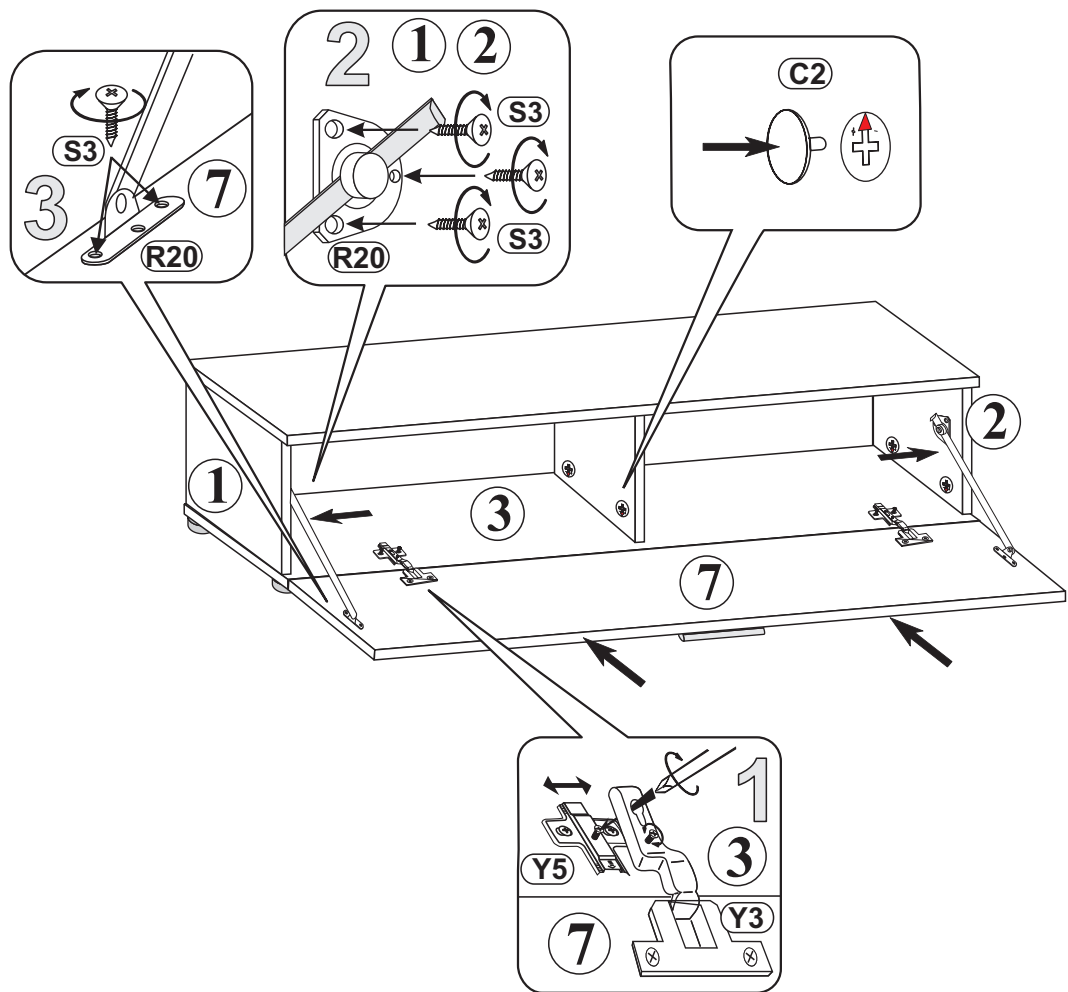

Modellname: **RUBI**
 Nazwa modelu:

Modellreihe: **P6--RB**
 Numer modelu:

Type: **30**
 Typ:

Blatt Nr **7** von: **7**
 Strona z:

5

