

Modellname: **RUBI**  
 Nazwa modelu:

Modellreihe: **P6--RB**  
 Numer modelu:

Type: **05**  
 Typ:

Blatt Nr **1** von: **8**  
 Strona z:

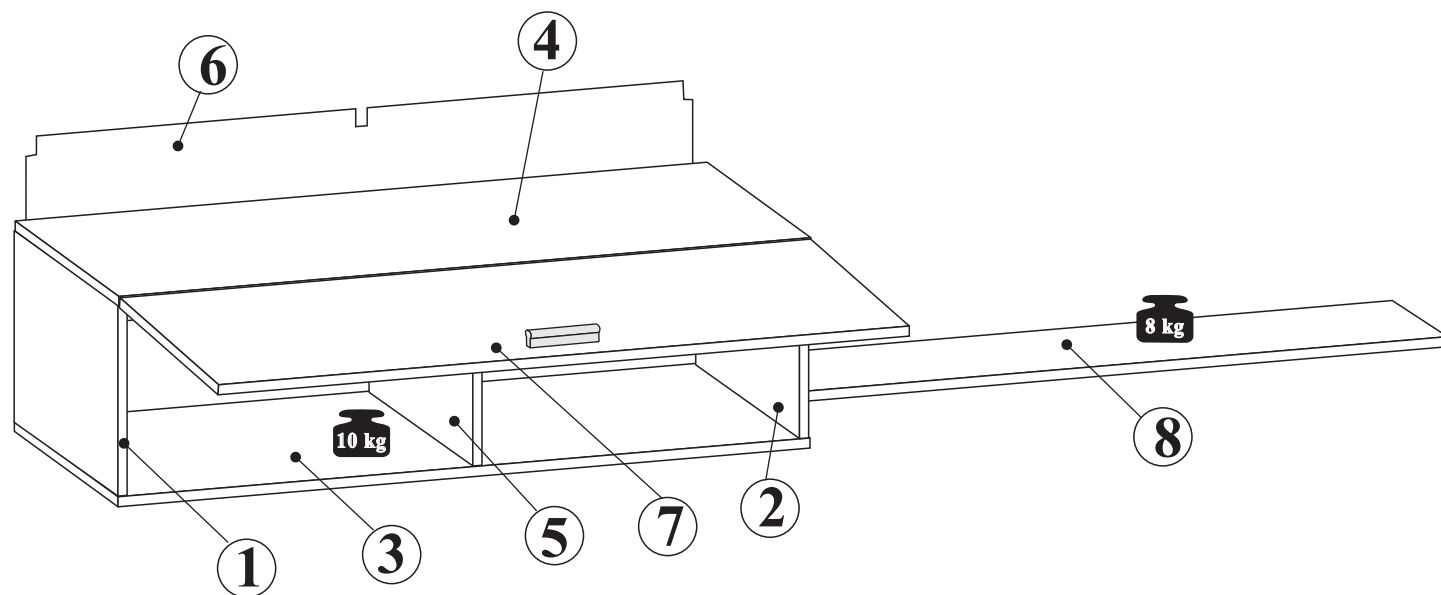
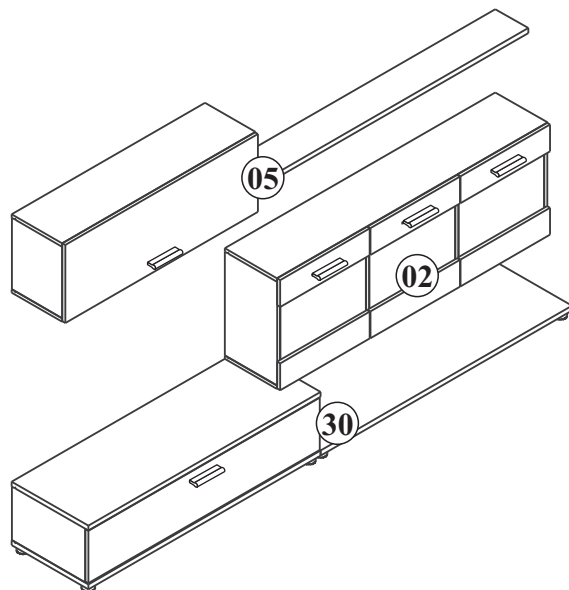

NO	Dim.		Col.-No	Qty
1	320	259	2	1
2	320	259	2	1
3	1000	260	2	1
4	1000	260	2	1
5	320	239	2	1
6	977	329	2	1
7	996	348	2	1
8	1500	170	2	1

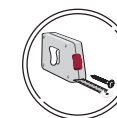
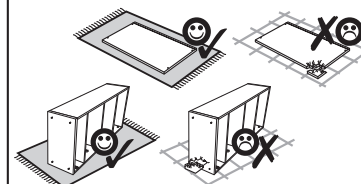
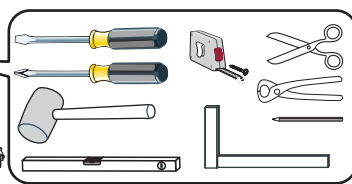
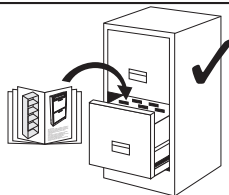

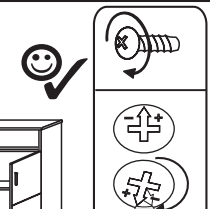
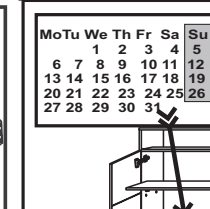
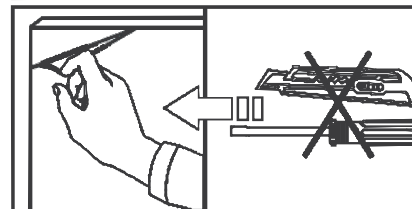
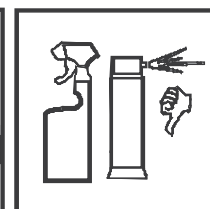
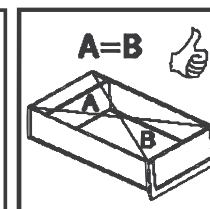
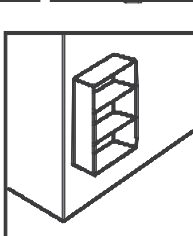
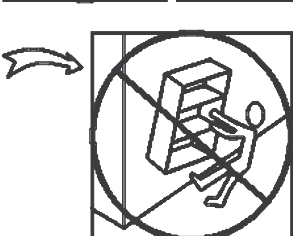
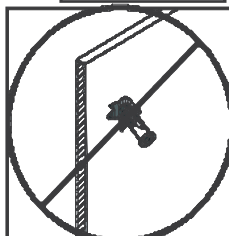
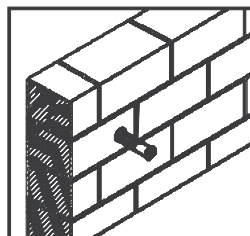
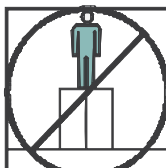
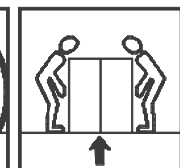
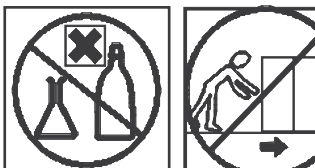
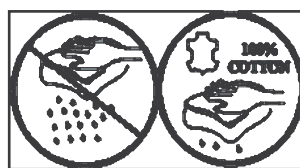
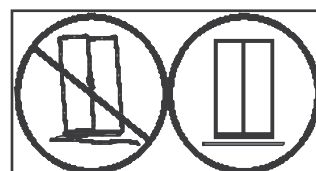
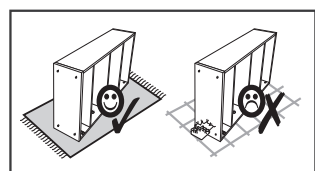
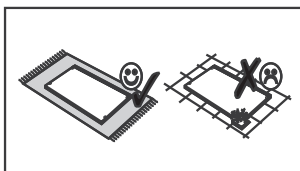
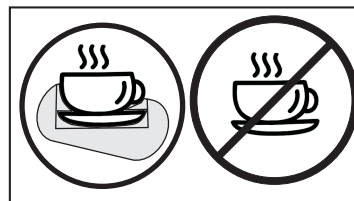
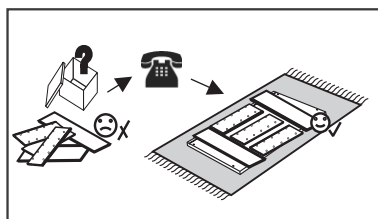
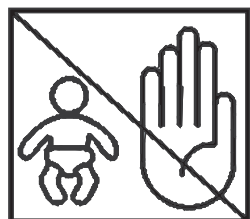
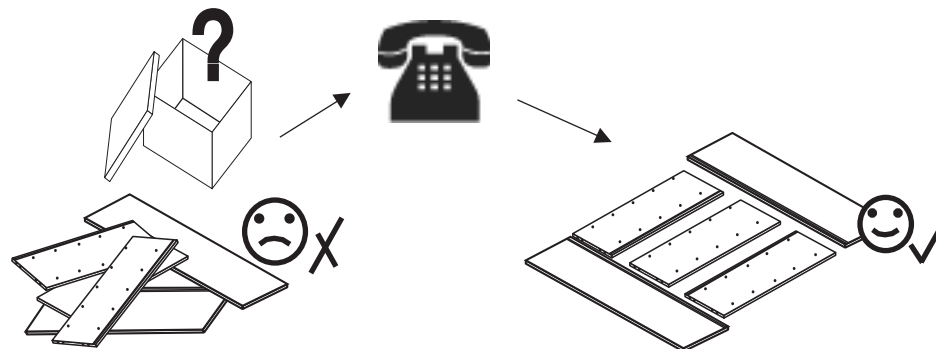

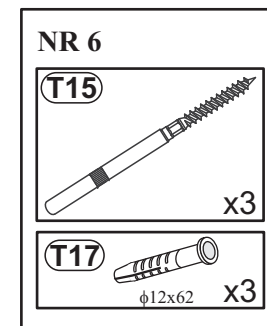
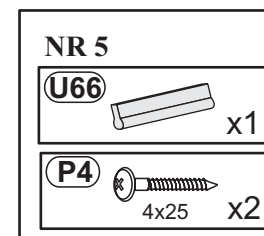
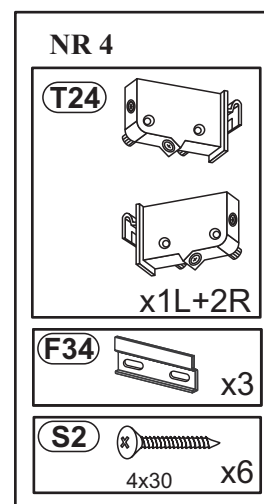
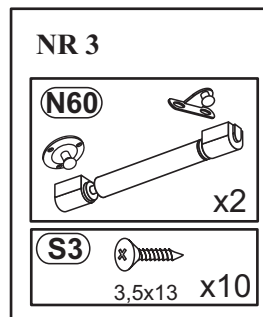
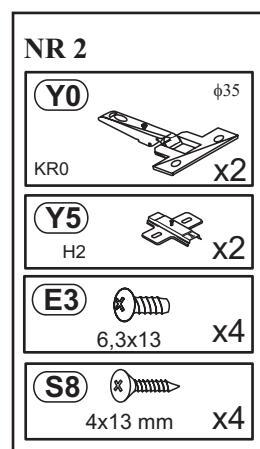
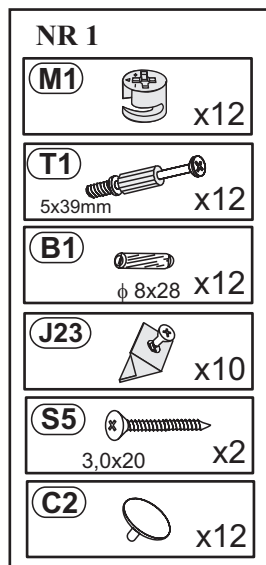

Modellname: **RUBI**  
 Nazwa modelu:

Modellreihe: **P6--RB**  
 Numer modelu:

Type: **05**  
 Typ:

Blatt Nr **4** von: **8**  
 Strona

**1**

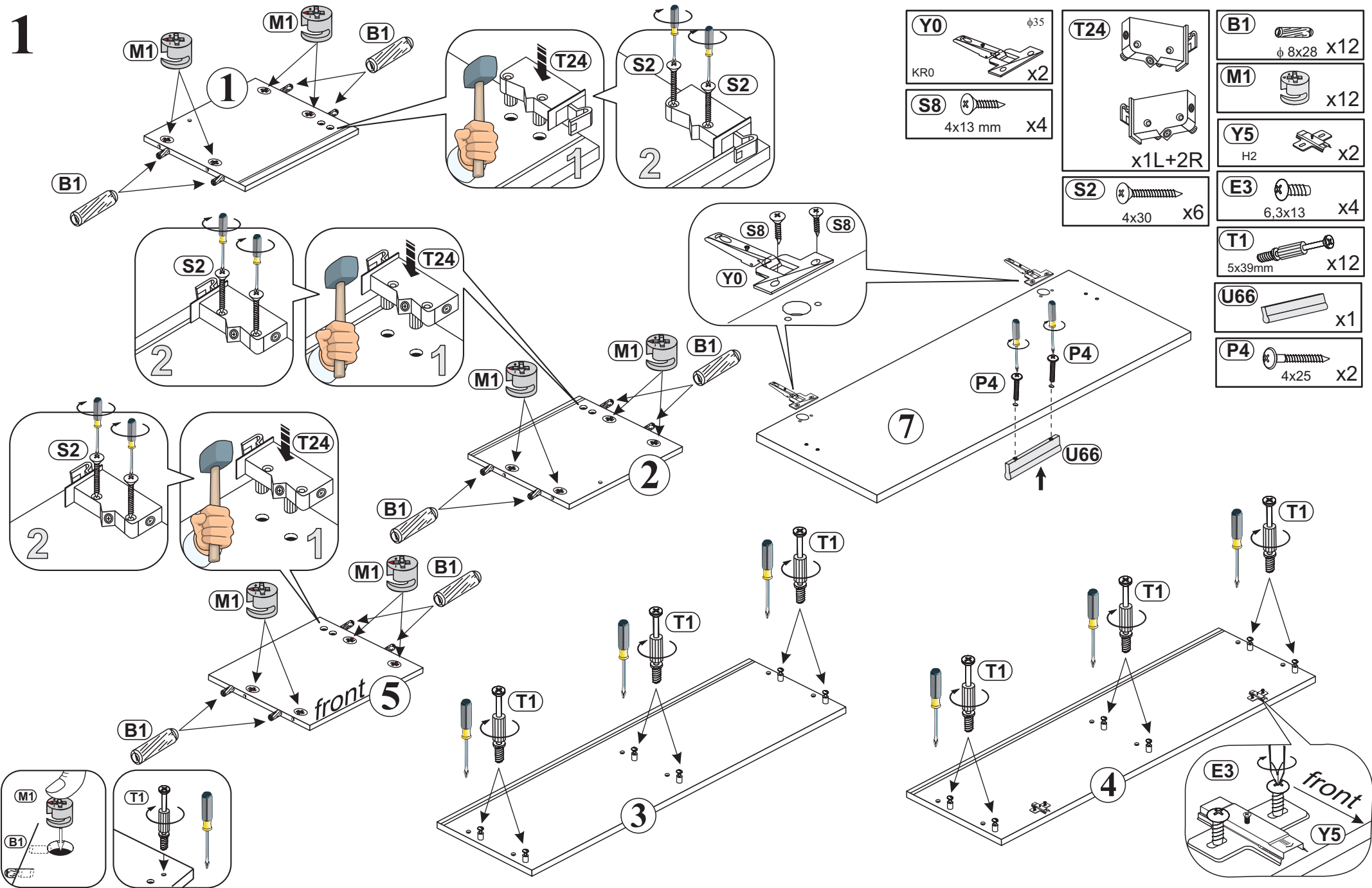

**2**

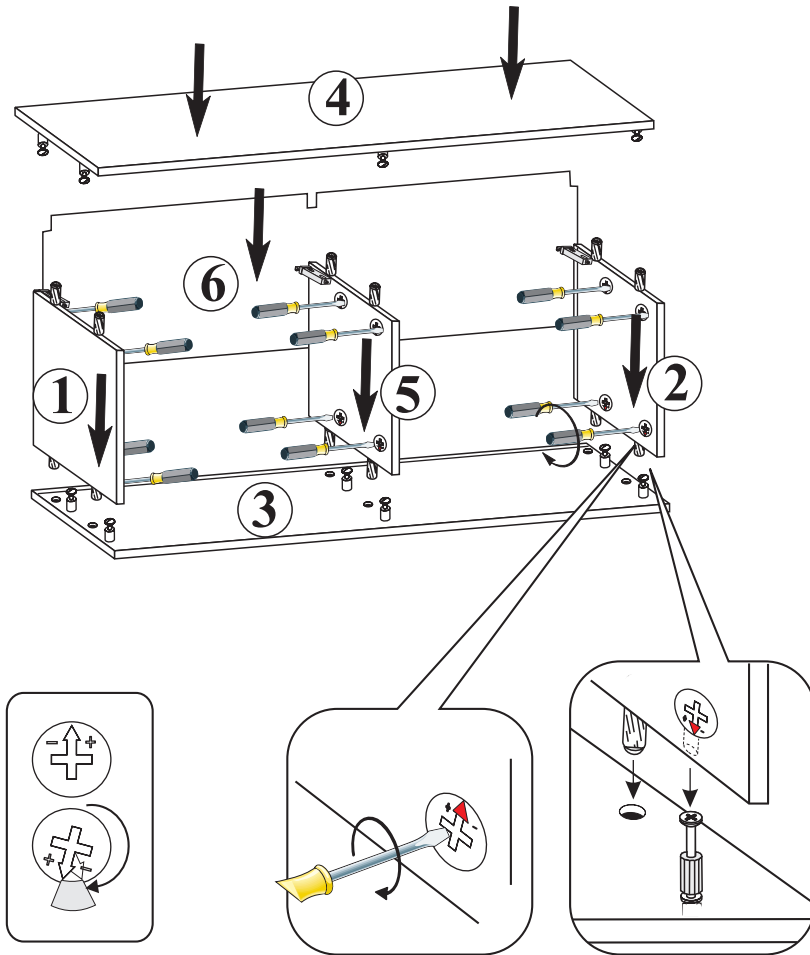

**3**

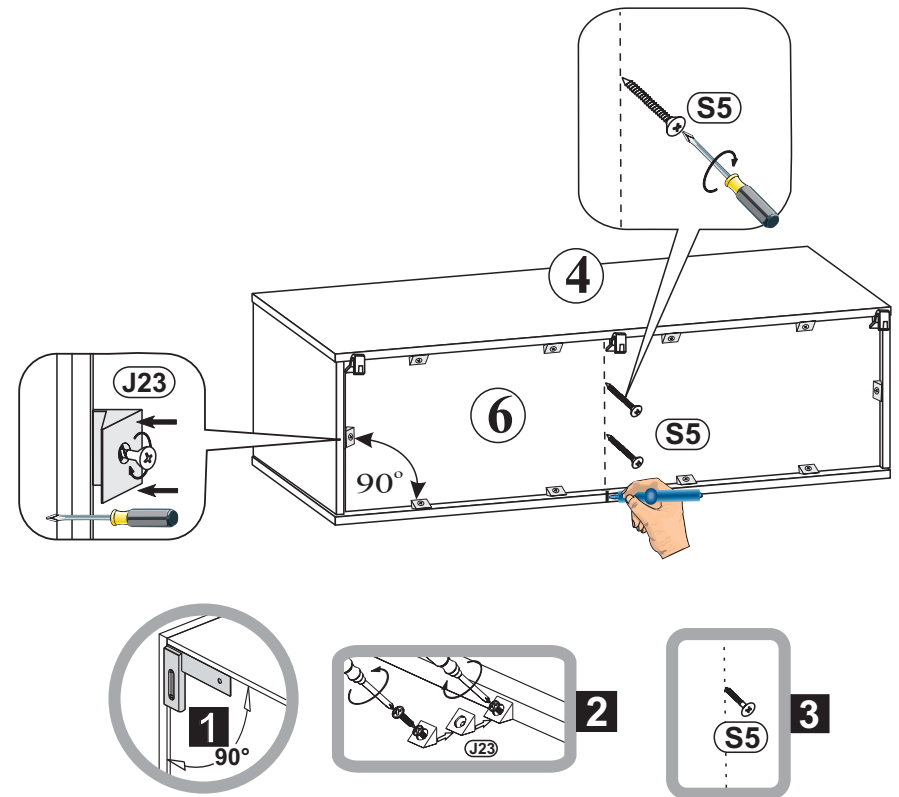
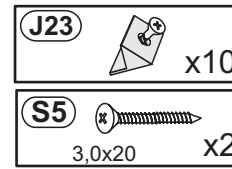

# 4

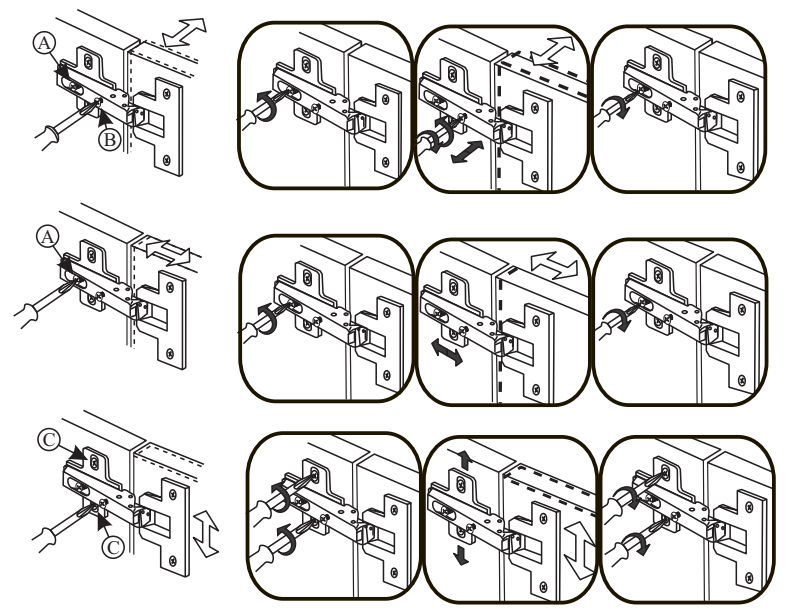
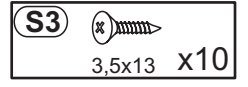
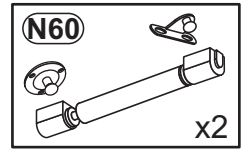
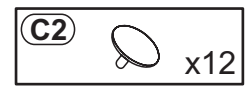
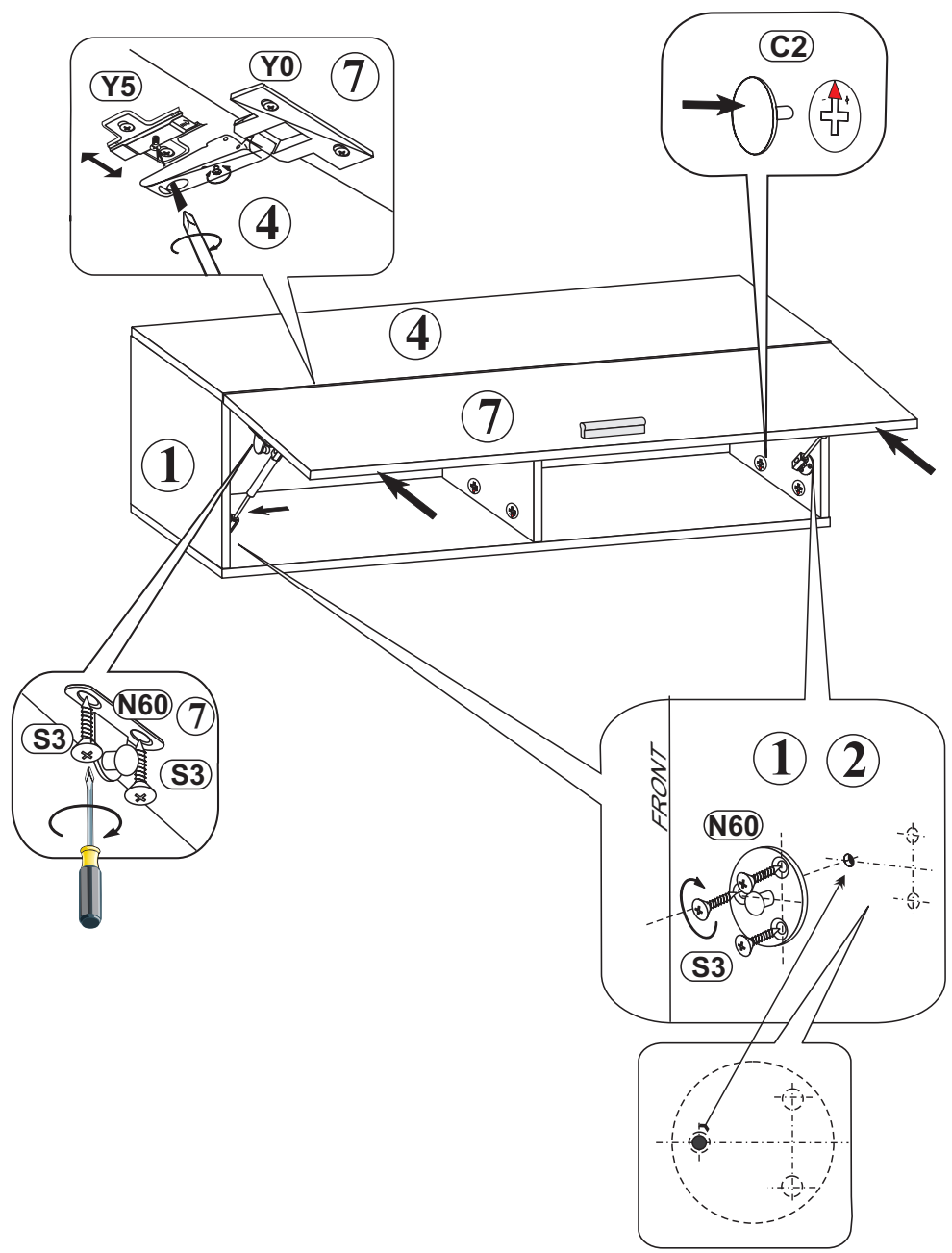

Modellname: **RUBI**  
Nazwa modelu:

Modellreihe: **P6--RB**  
Numer modelu:

Type: **05**  
Typ:

Blatt Nr 7 von: 8  
Strona z:

5

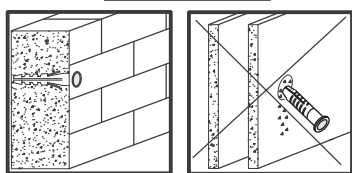
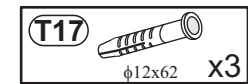
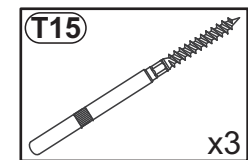
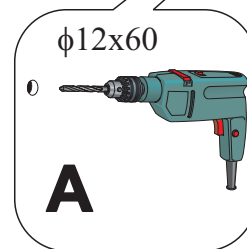
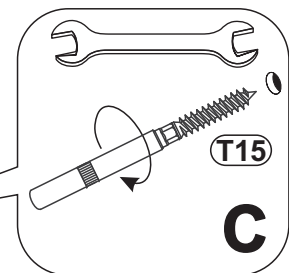
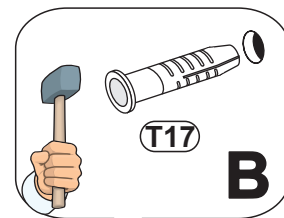
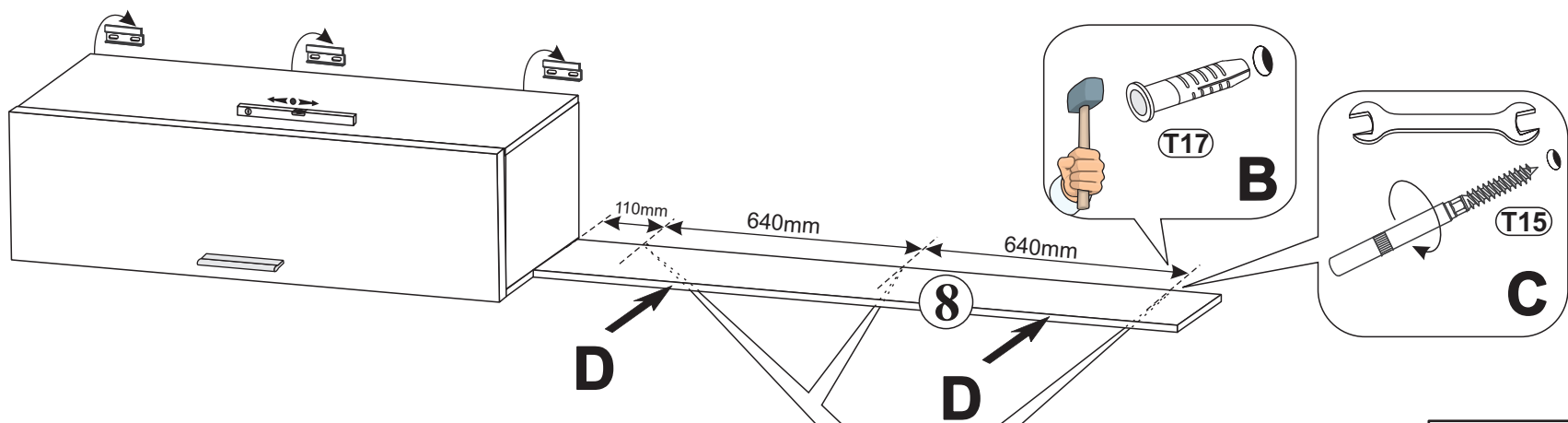
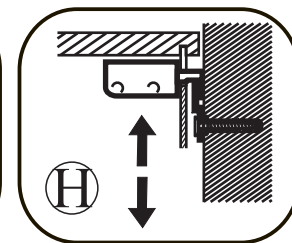
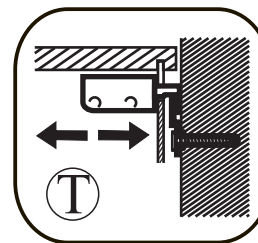
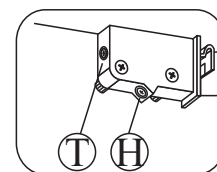
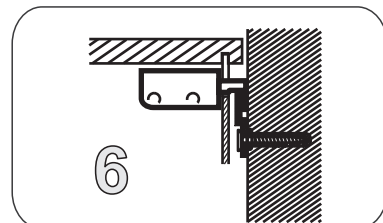
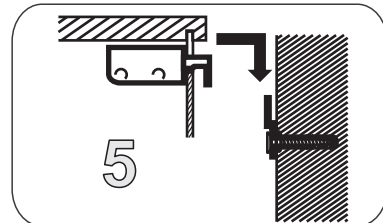
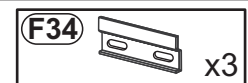
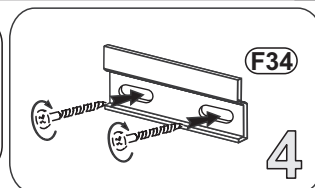
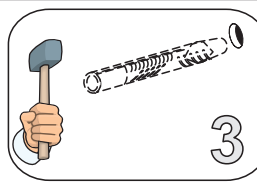
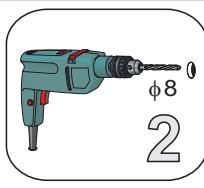
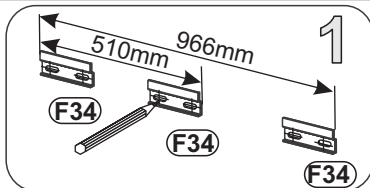
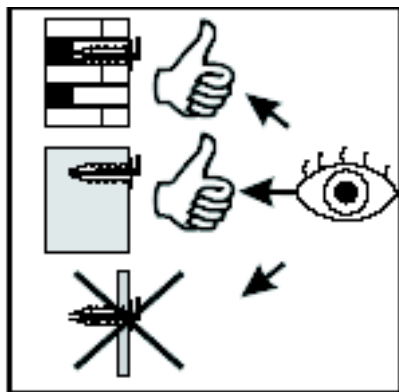

Modellname: **RUBI**  
Nazwa modelu:

Modellreihe: **P6--RB**  
Numer modelu:

Type: **05**  
Typ:

Blatt Nr **8** von: **8**  
Strona z:

