

MICHELLE

P6--LE

type: 30

1 / 9

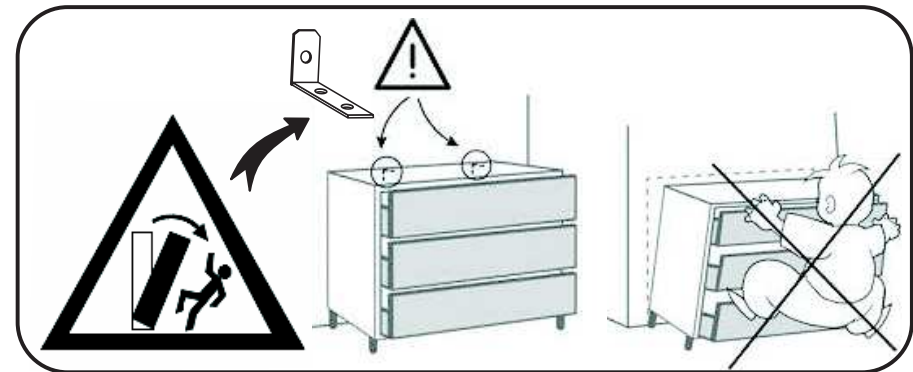
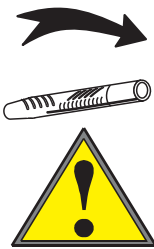
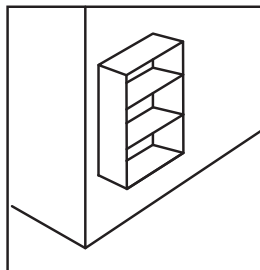
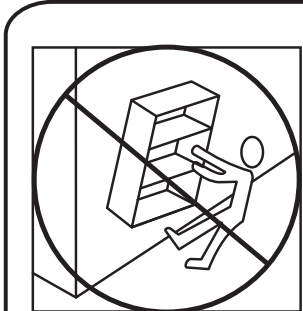
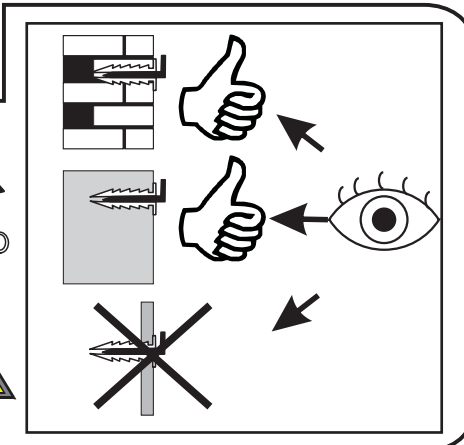
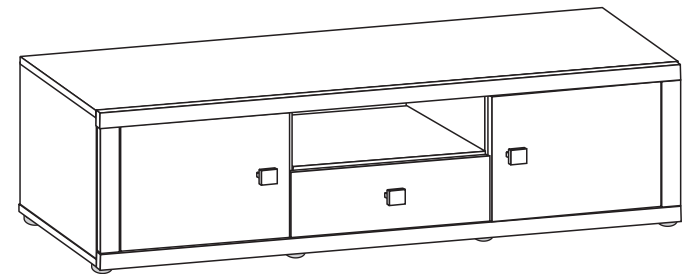
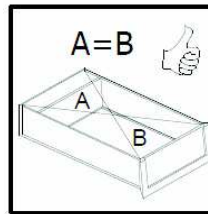
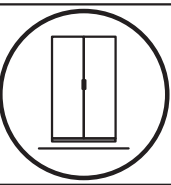
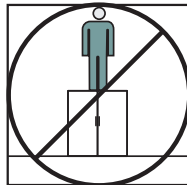
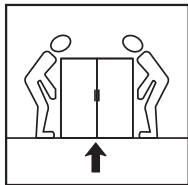
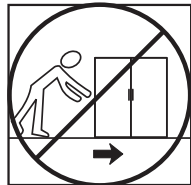
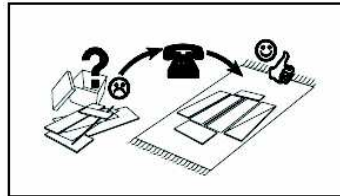
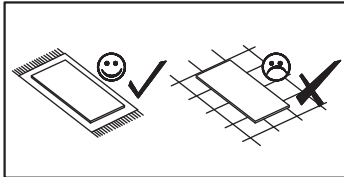
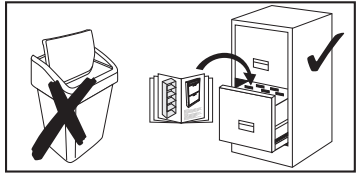
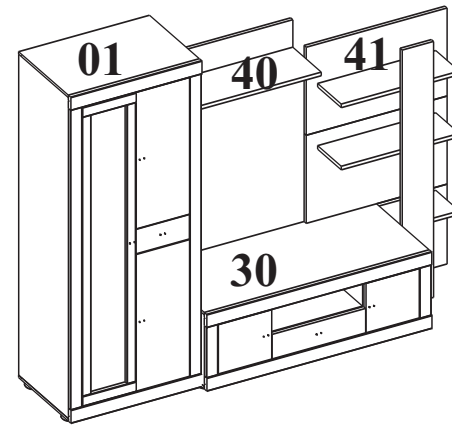
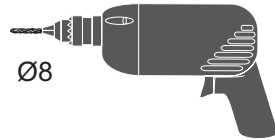
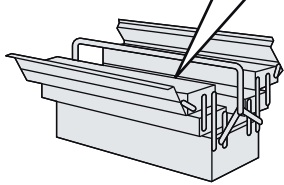
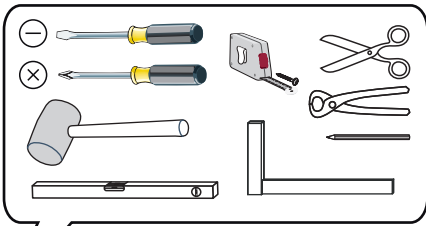
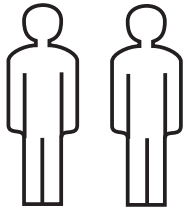

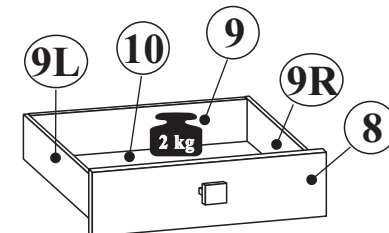
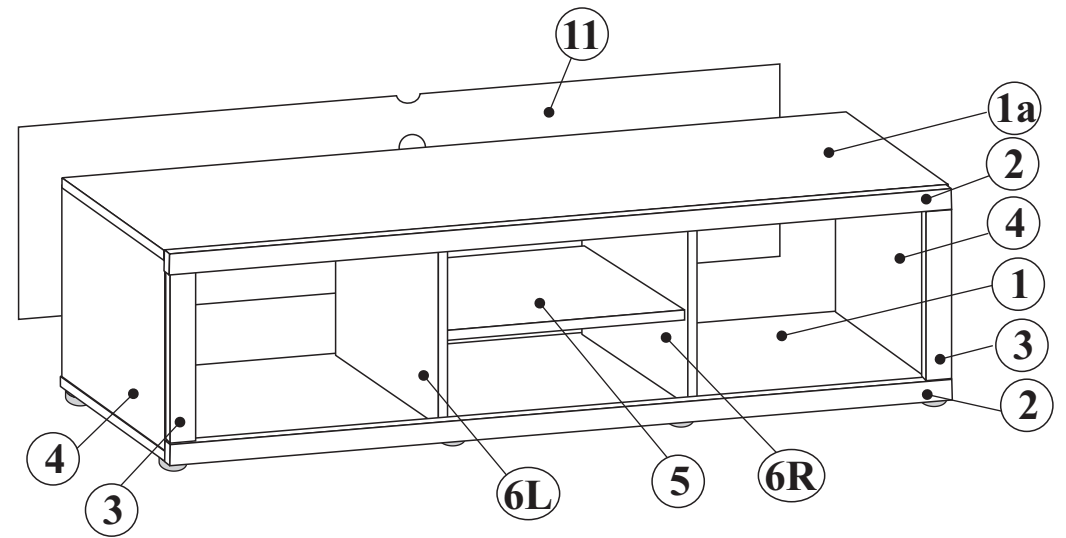
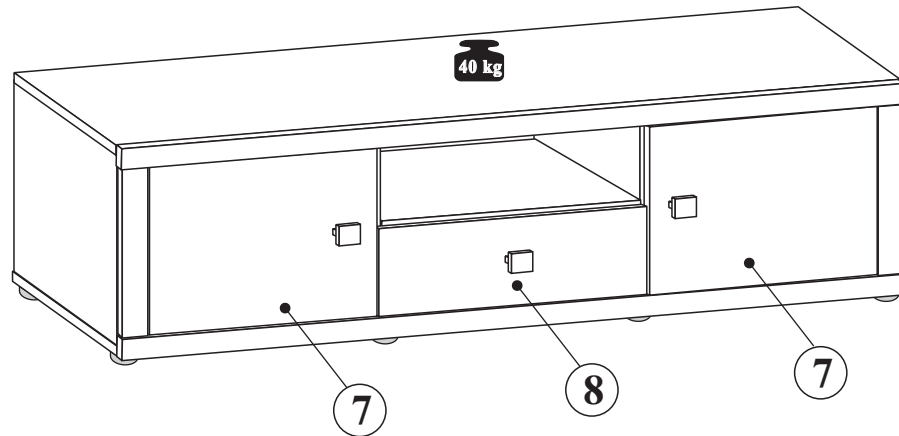



1	1580	385	1	3/4
1a	1580	385	1	3/4
2	1581	80	2	3/4
3	306	80	2	3/4
4	435	385	2	3/4
5	645	364	1	3/4
6L,6R	435	365	2	3/4
7	300	375	2	3/4
8	657	149	1	3/4
9L,9R	302	100	2	3/4
9	596	100	1	3/4
10	607	300	1	3/4
11	1557	443	1	3/4

NR 1

B1  ϕ 8x28 x28

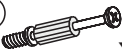
M1  ϕ 15x12mm x20

T1  5x39mm x20

J23  x14

P2  3x20 x9

F33  x12

P13  3,5x13 x48

C14  ϕ 20mm x12

NR 2

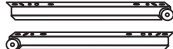
R21 L-300 mm  x1L/1R

E24  6,0x11 x6

S3  3,5x13 x2

P10  3x13 x4

NR 3

U84  x3

P4  4x25 x6

NR 4

M2  ϕ 12x10mm x2

T2  5x35mm x2

P5  4x30 x2

NR 5

F10  x8

P4  4x25 x8

J11  x1

P13  3,5x13 x2

NR 6

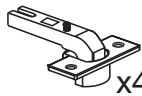
SR  ϕ 26 x4

D4 H-4  x4

E3  6,3x13 x8

S8  4x13 x8



1

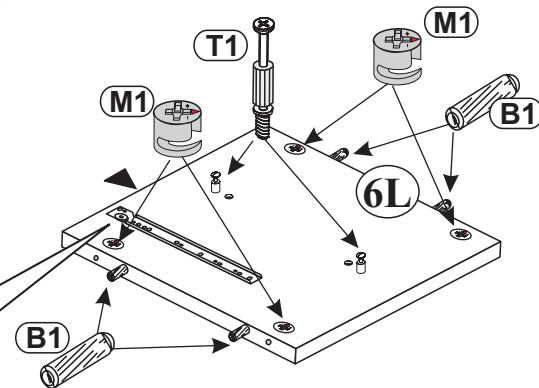
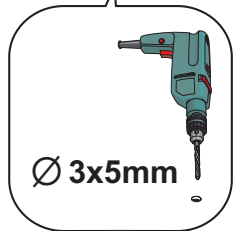
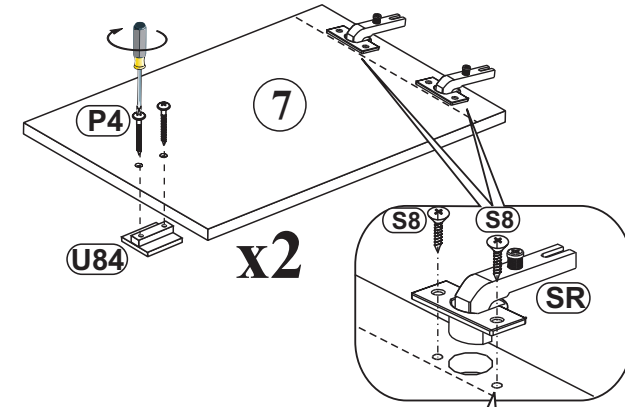
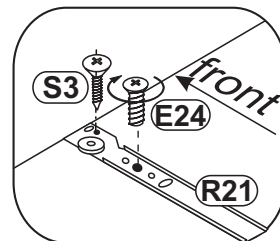
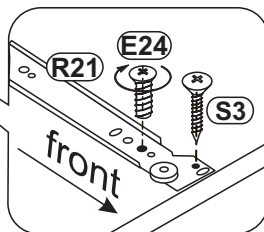
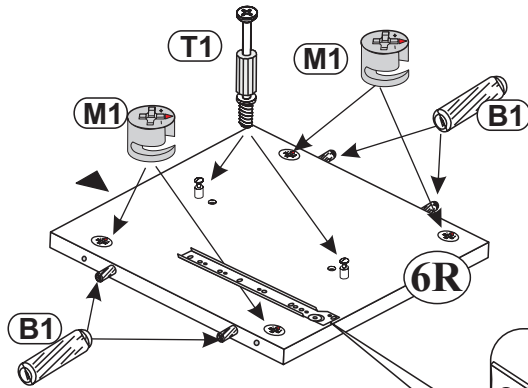
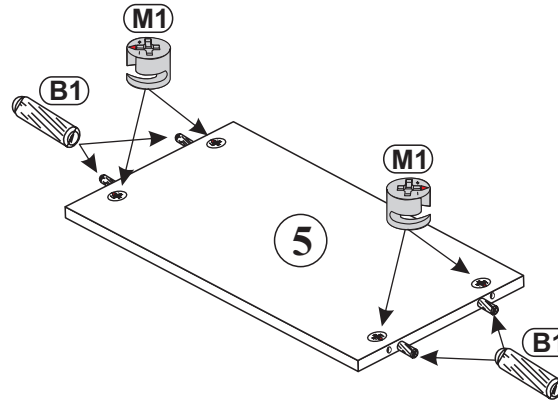
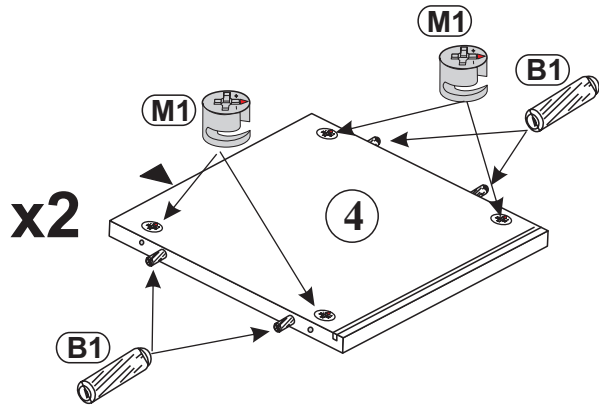
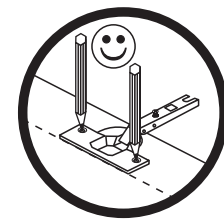
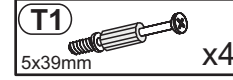
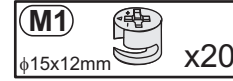
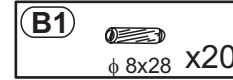
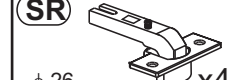
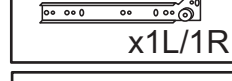
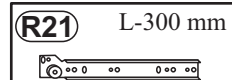
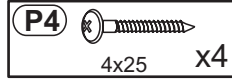
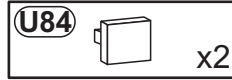
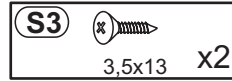
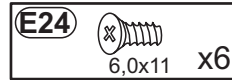
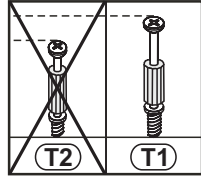
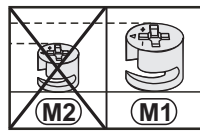
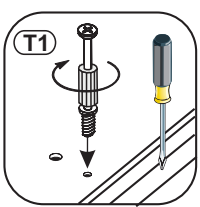
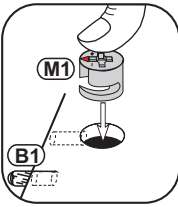

2

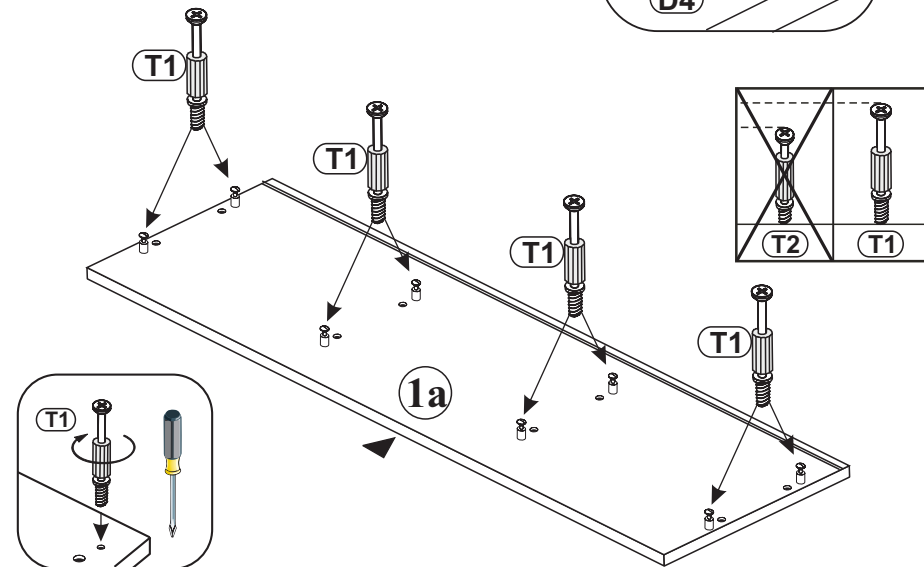
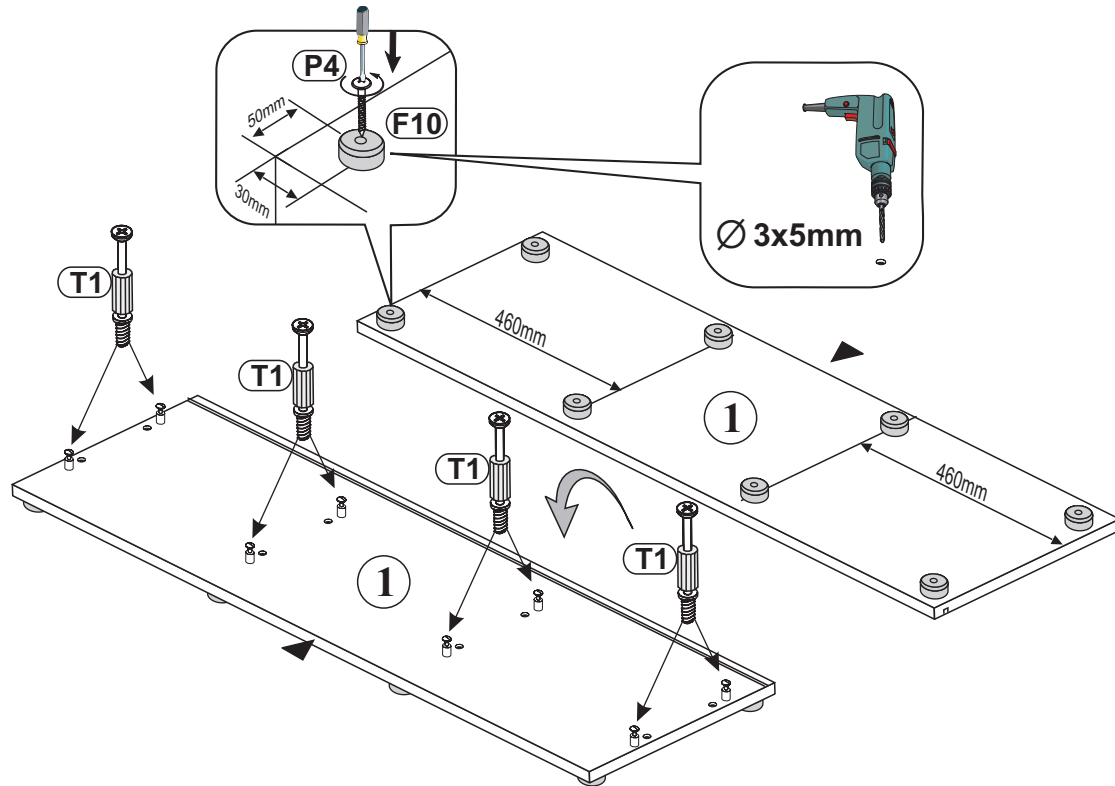
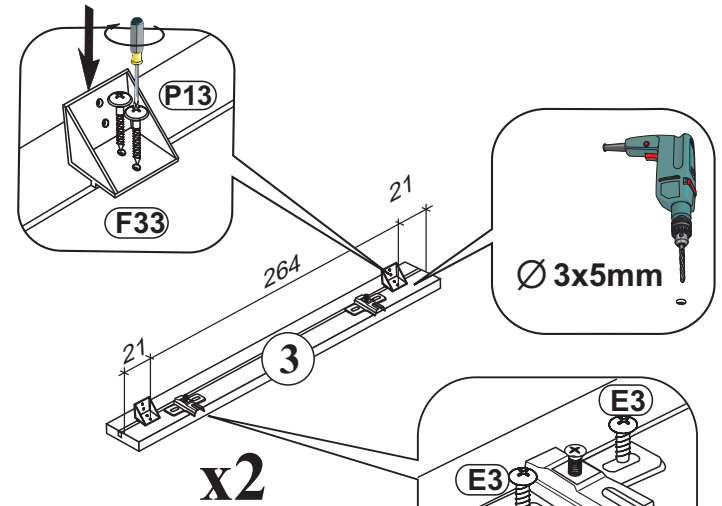
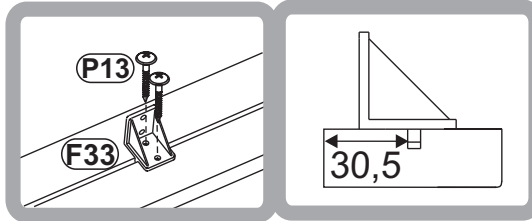
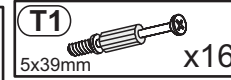
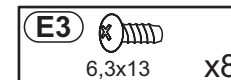
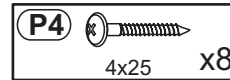
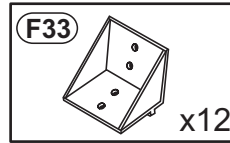
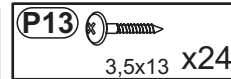
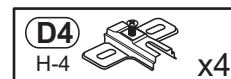
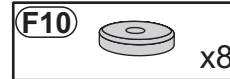
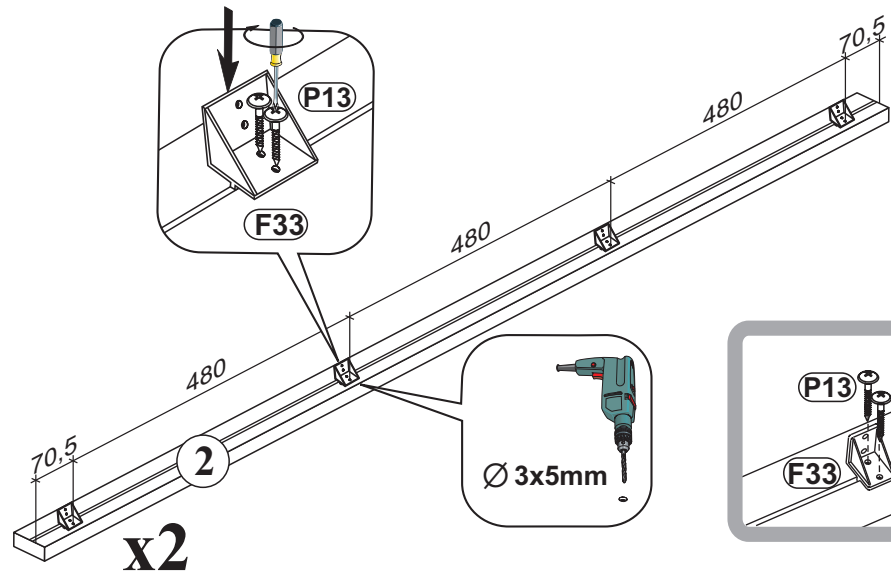

3

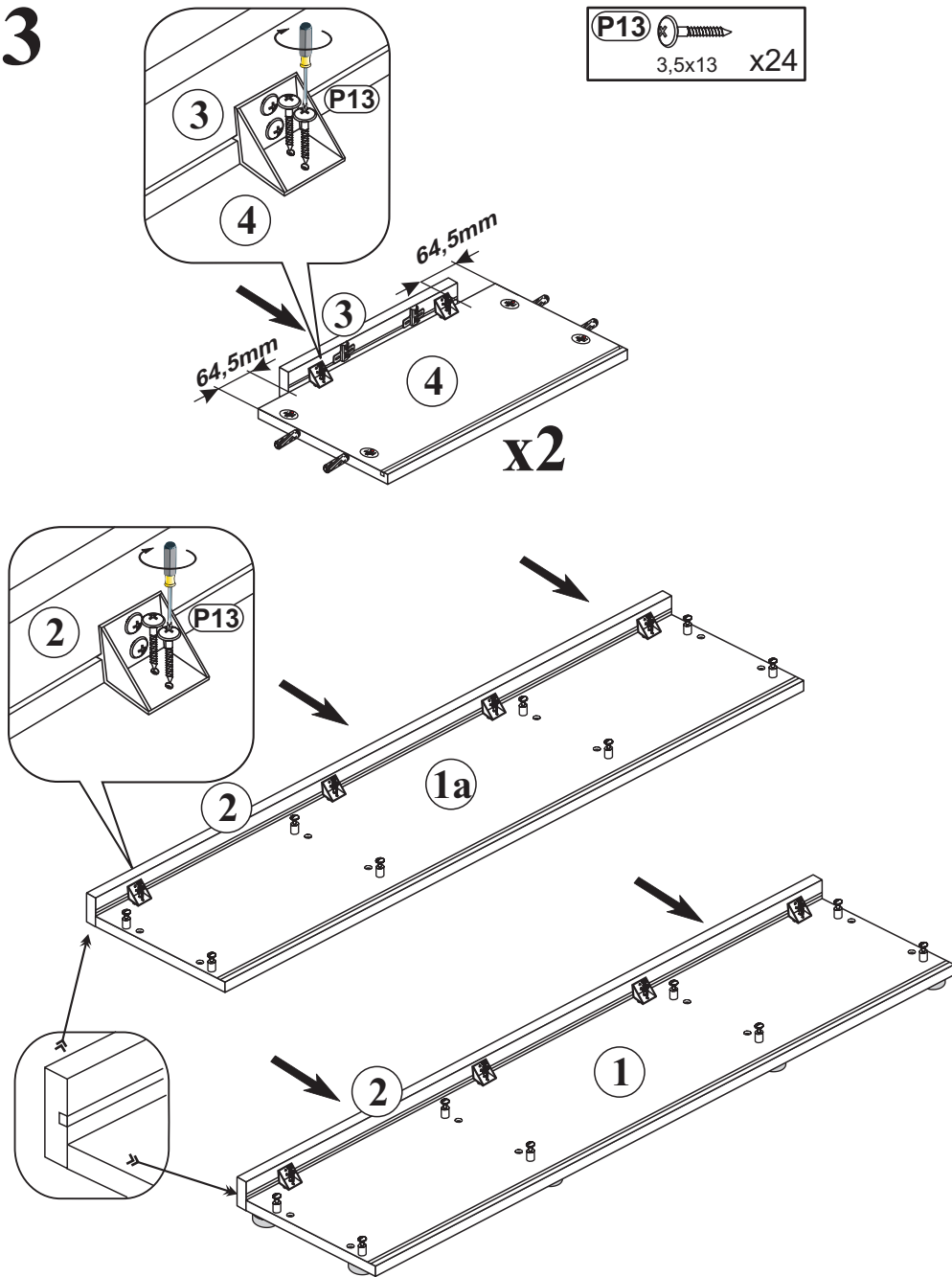

4

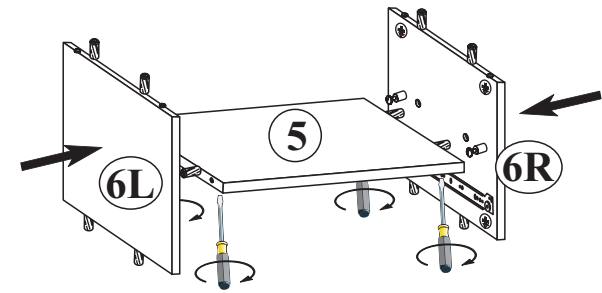

5

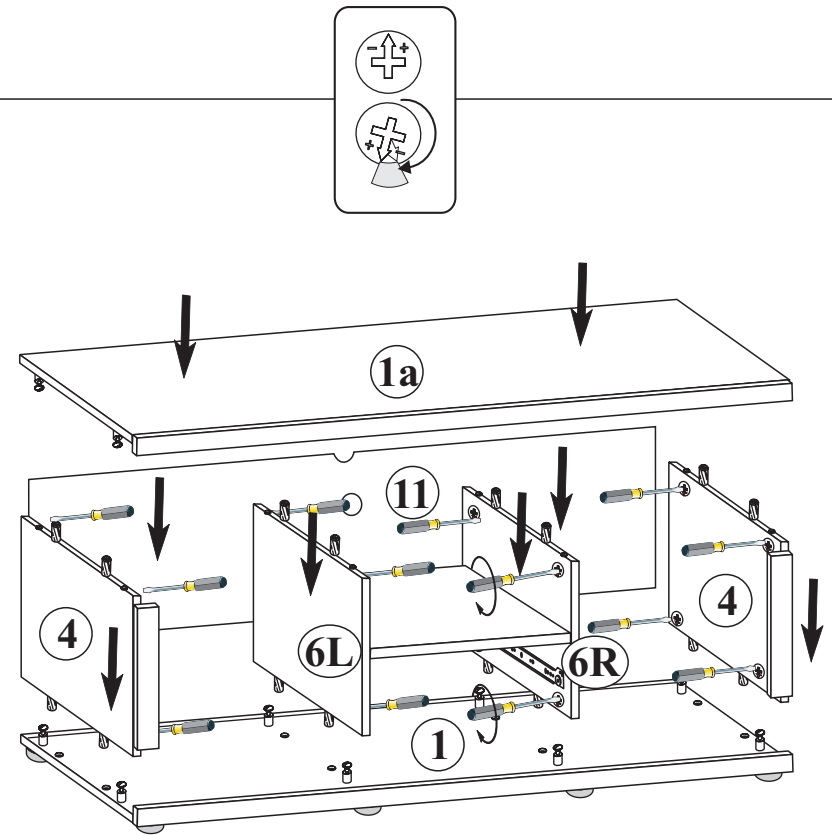

6

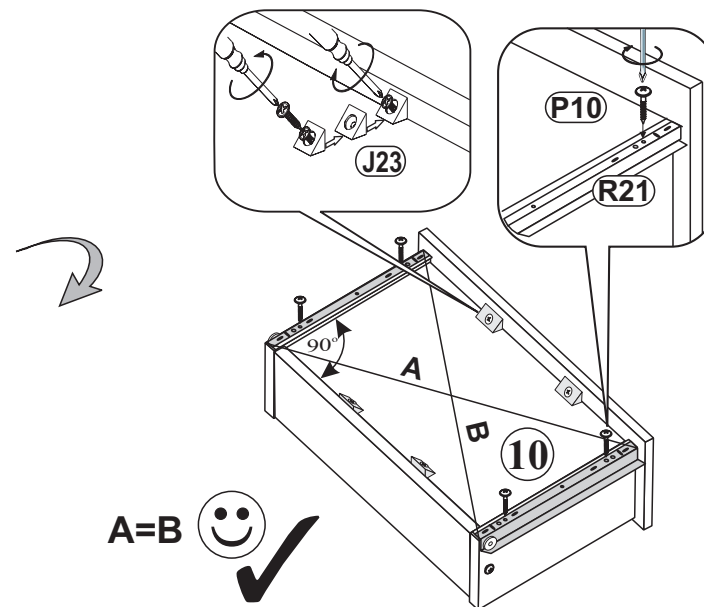
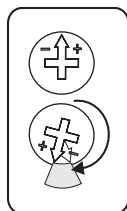
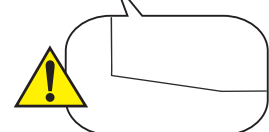
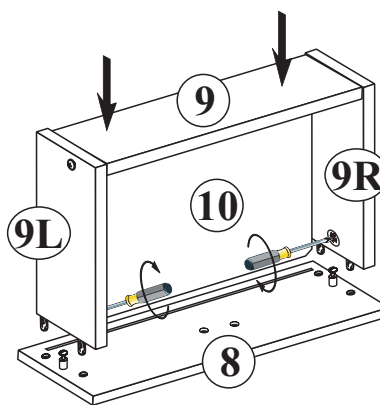
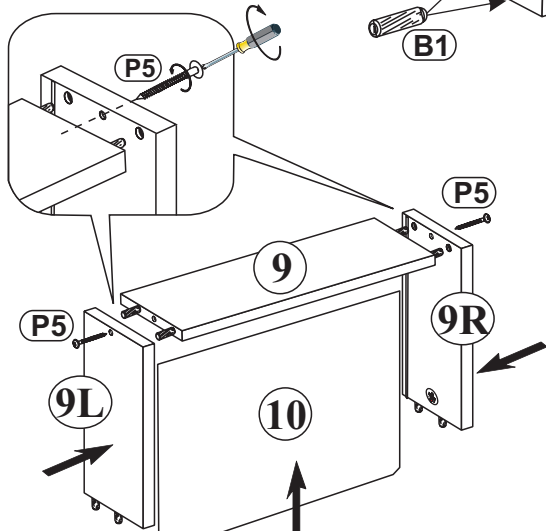
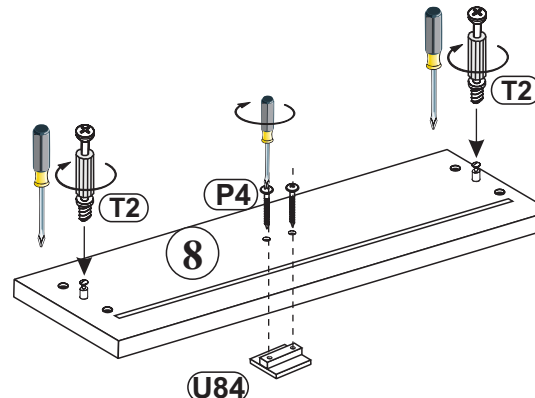
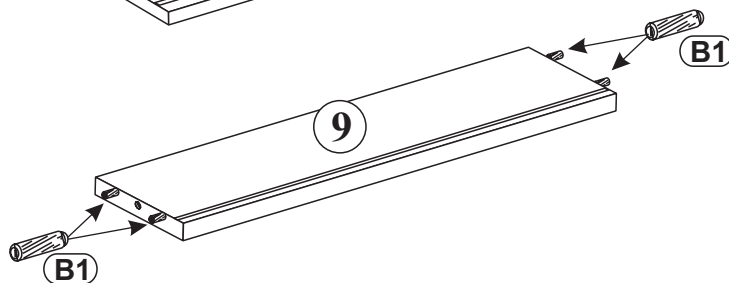
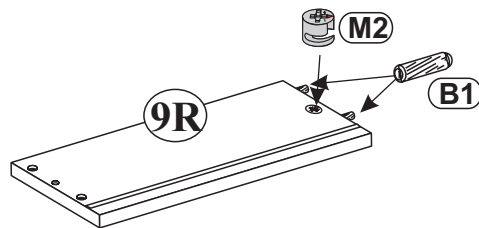
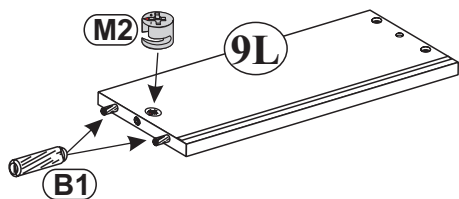
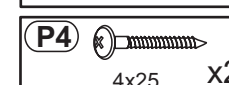
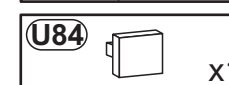
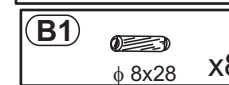
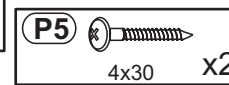
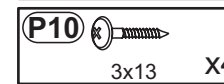
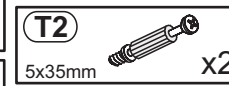
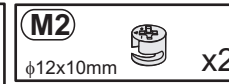
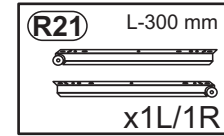
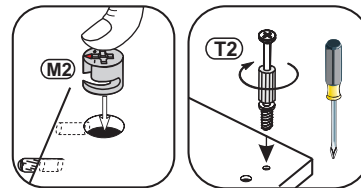
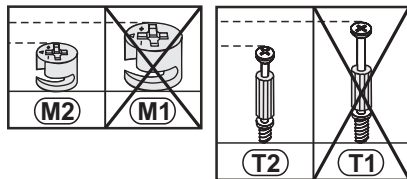

A=B 😊 ✓

7

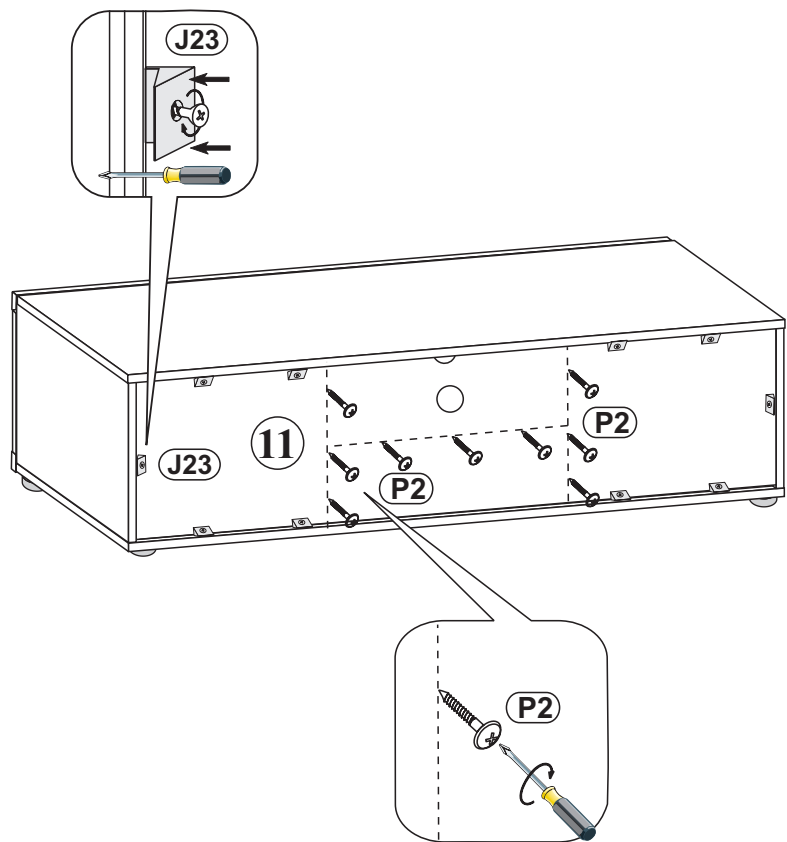
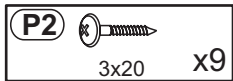

8

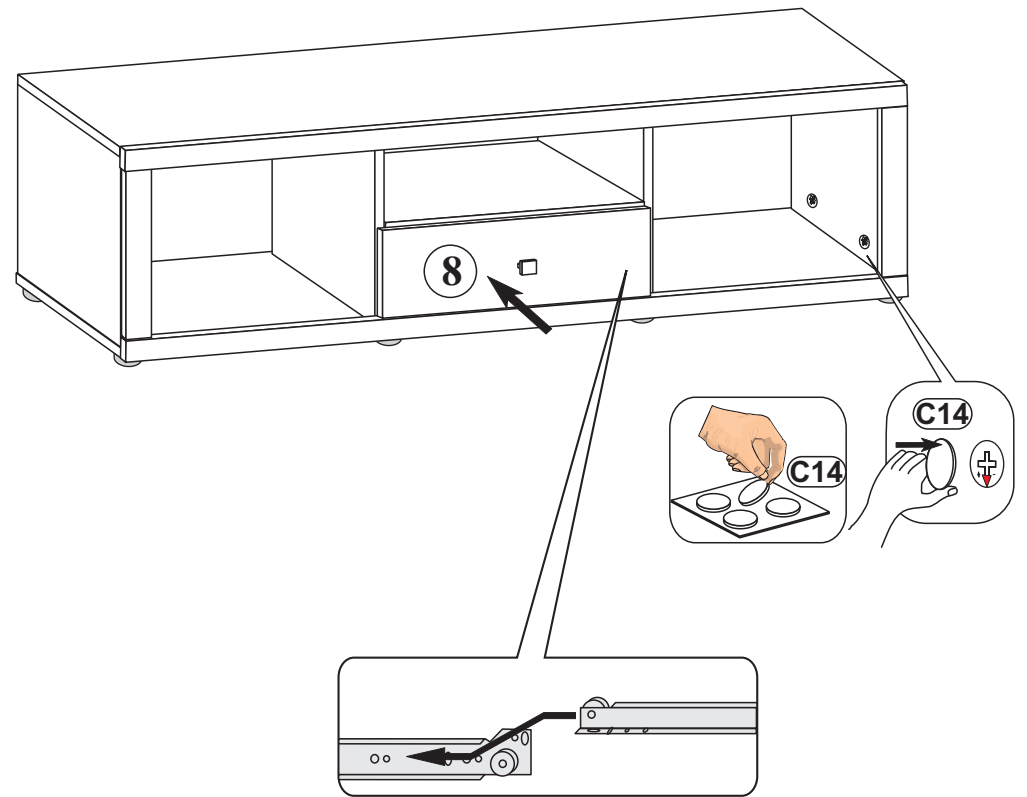
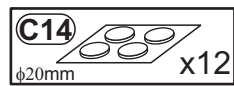

9

