

MICHELLE

P6--LE

type: 40+41

1 / 6

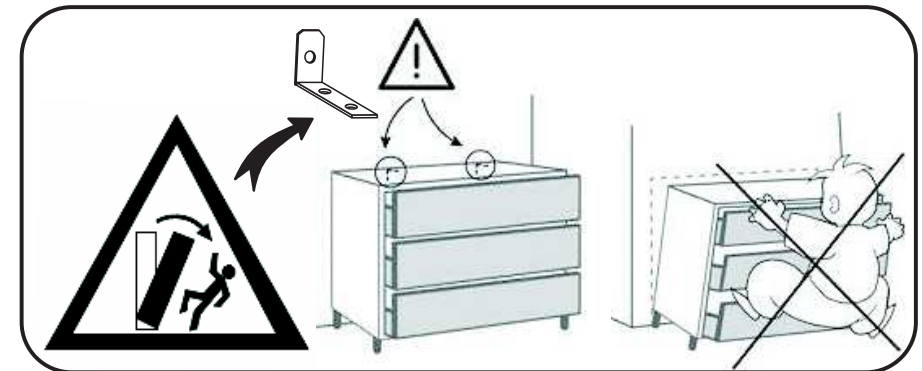
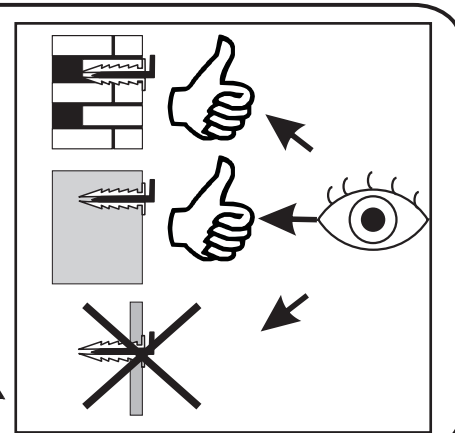
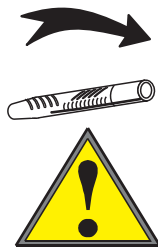
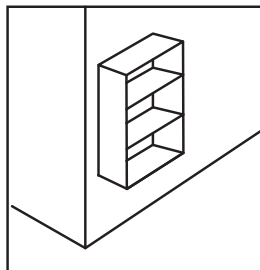
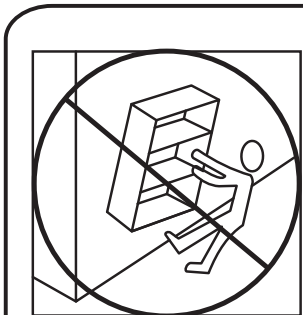
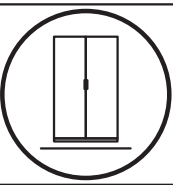
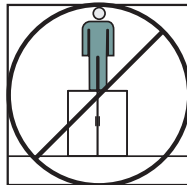
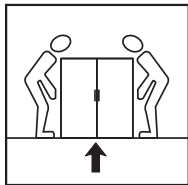
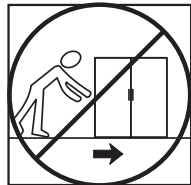
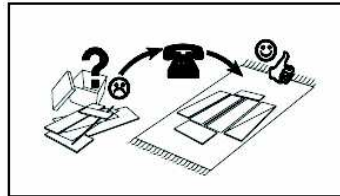
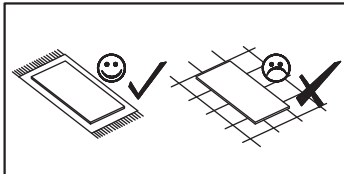
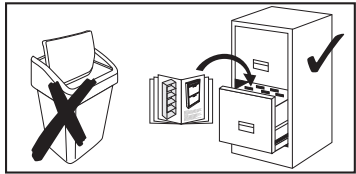
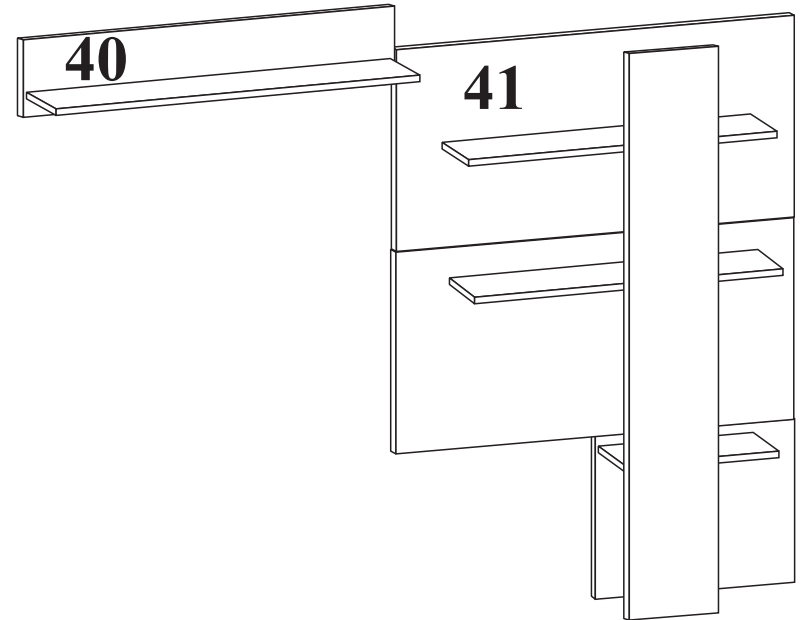
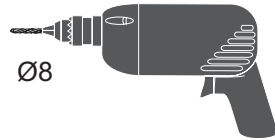
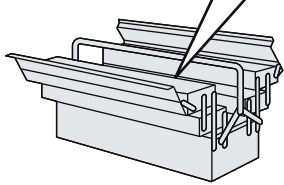
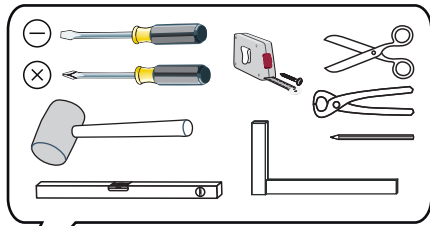
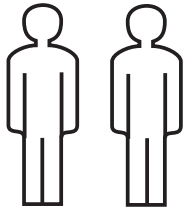

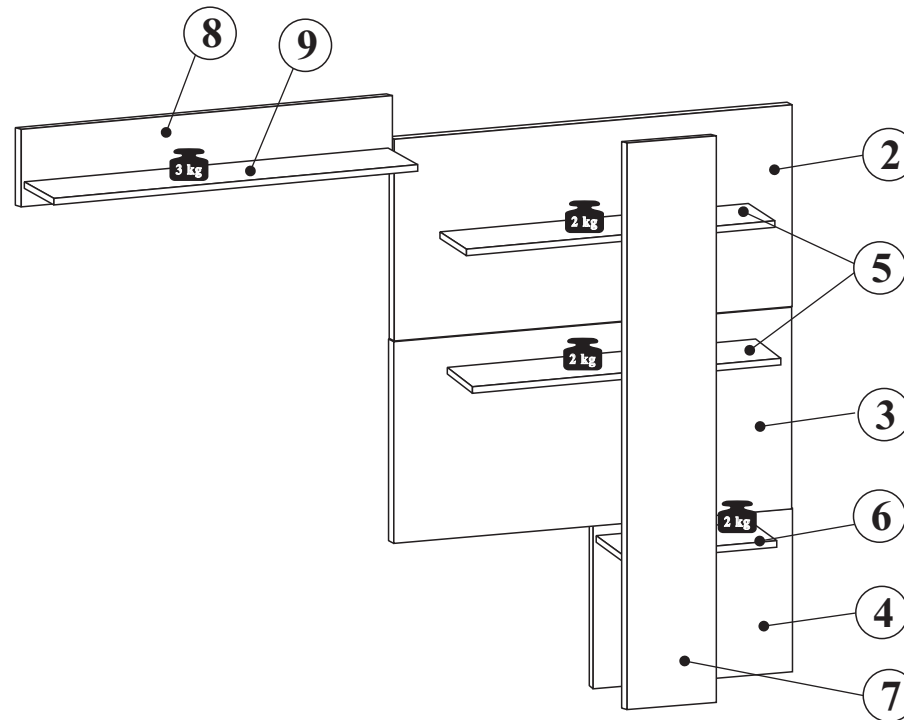
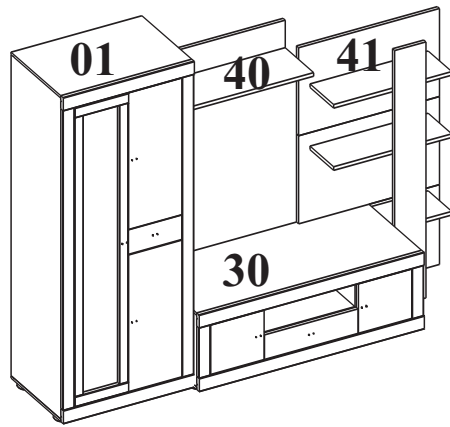

Nr 1

B1 $\phi 8 \times 28$ x6

M1 $\phi 15 \times 12 \text{mm}$ x3

T1 5x39mm x3

K1 7x50 x15

Nr 2

F50 x5

E2 6x8 x10

T10 x5

F18 x5

E24 6,0x11 x20

Nr 3

C14 $\phi 20 \text{mm}$ x3

F15 x2

C22 3,5mm x3

L1 x1

2	990	535	1	4/4
3	990	535	1	4/4
4	495	485	1	4/4
5	830	166	2	4/4
6	415	166	1	4/4
7	1555	220	1	4/4
8	900	240	1	4/4
9	898	200	1	4/4



MICHELLE

P6--LE type: 40+41

3 / 6

1

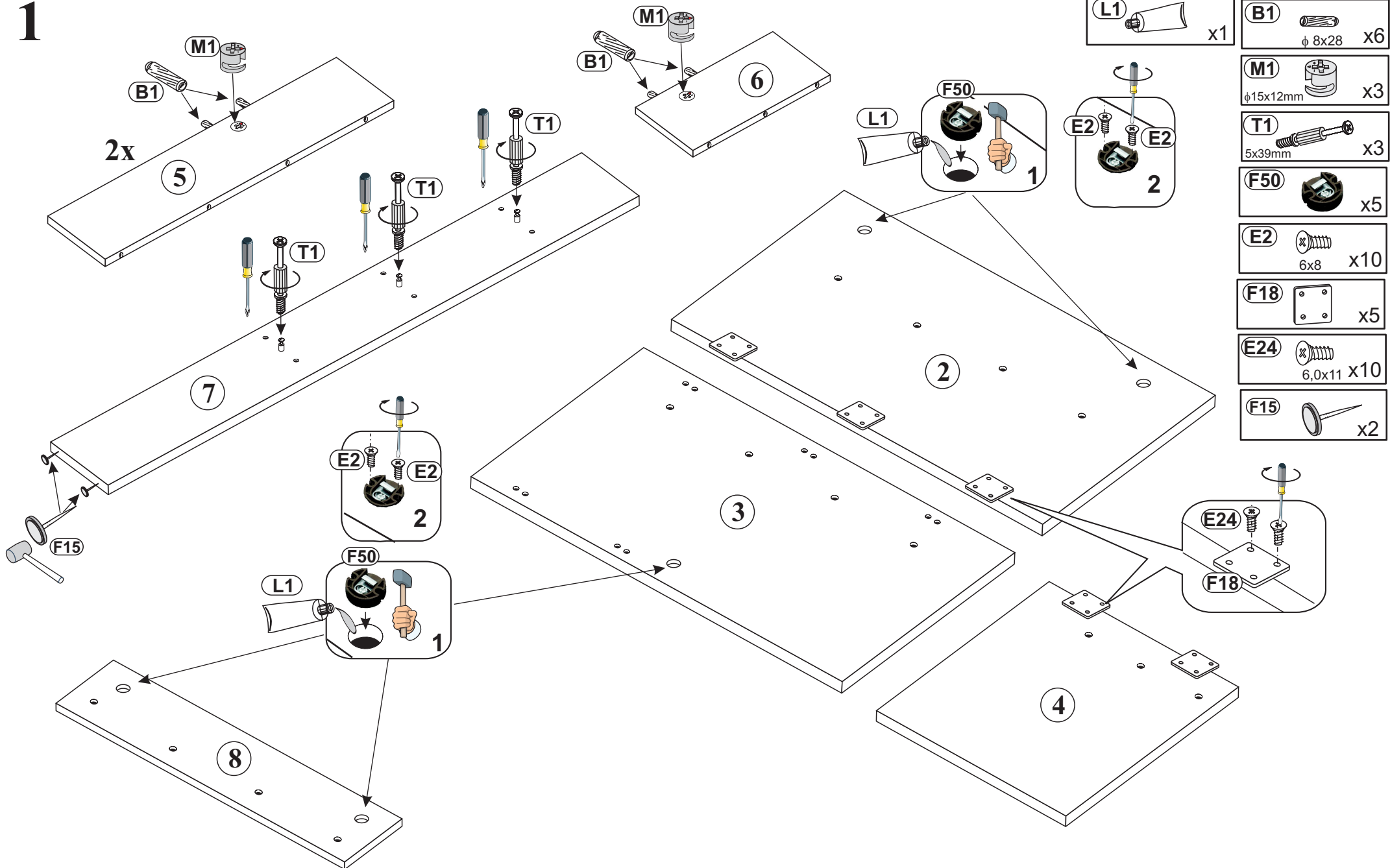

2

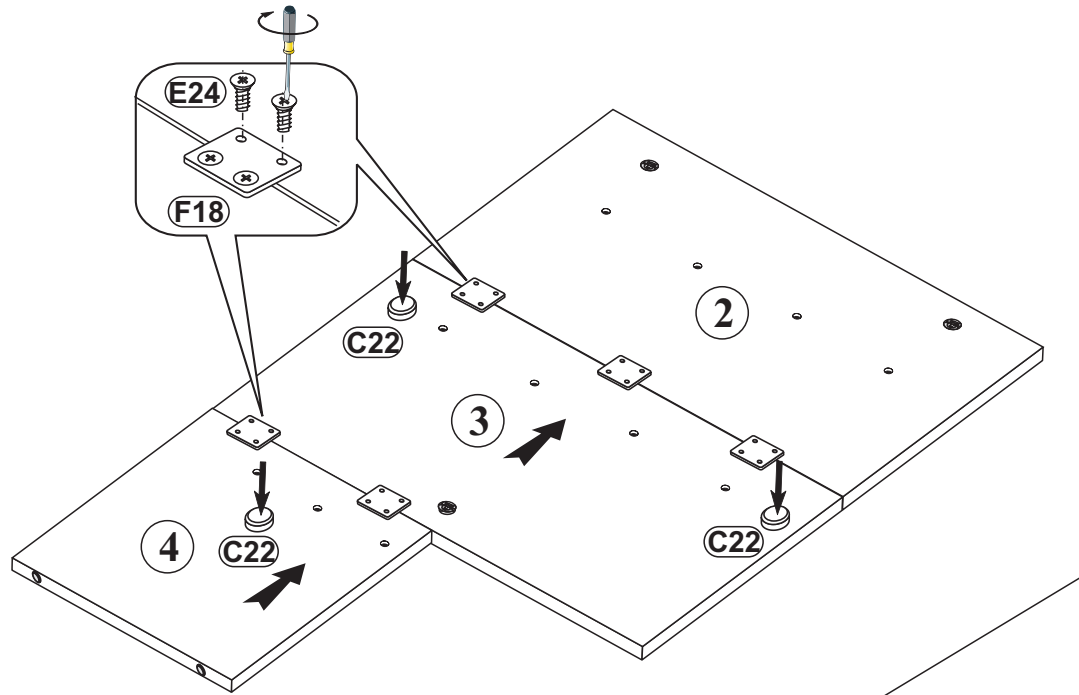
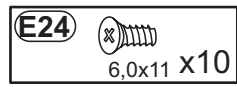

3

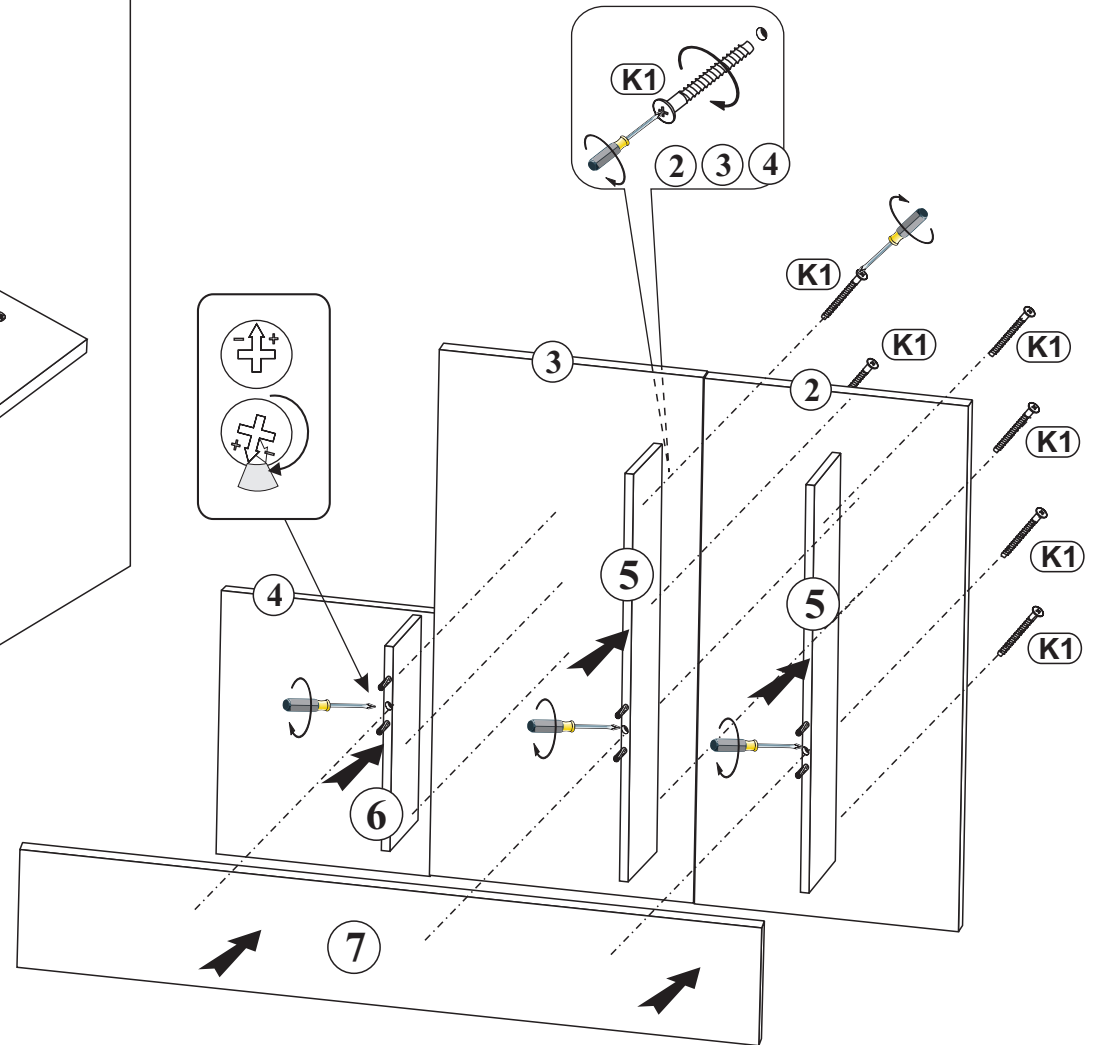
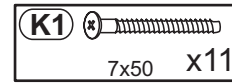

4

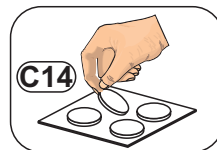
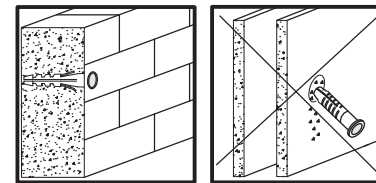
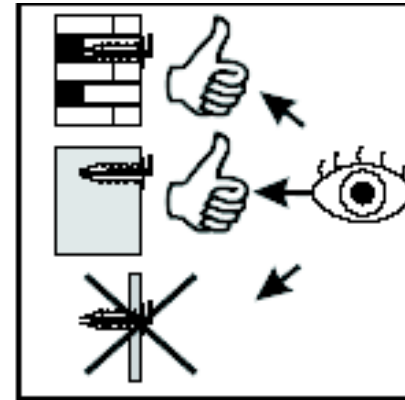
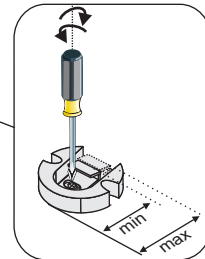
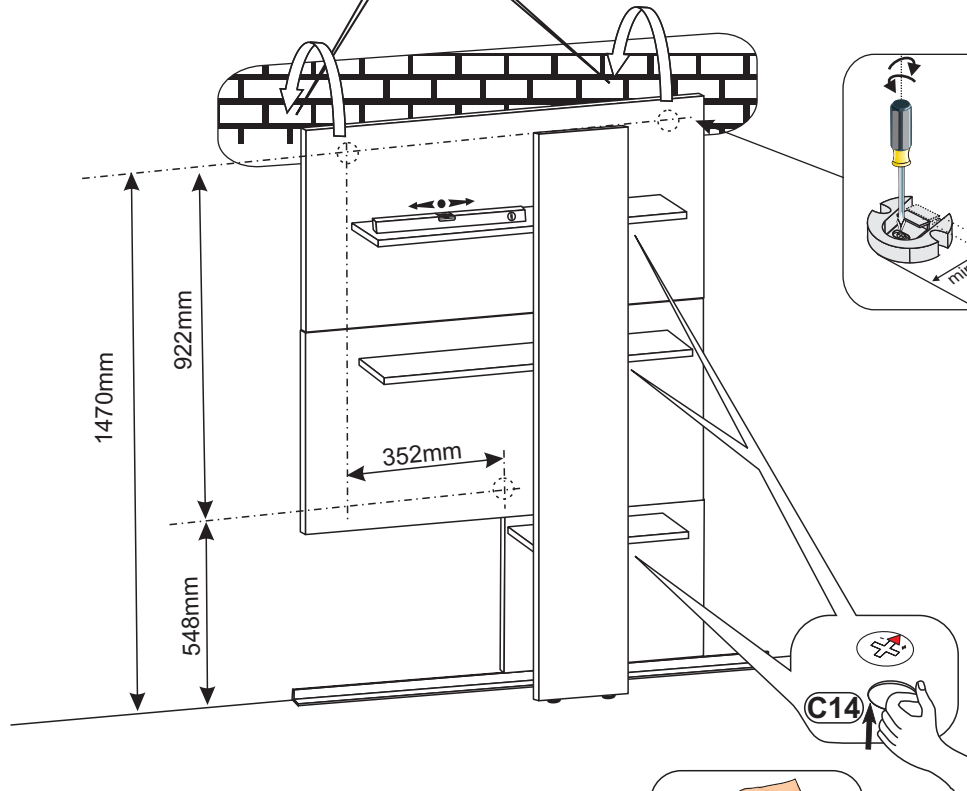
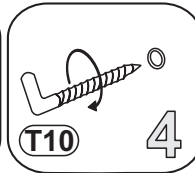
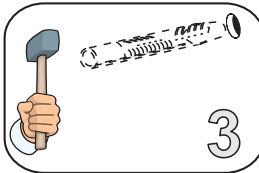
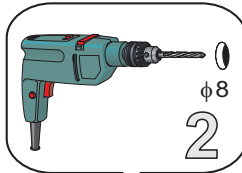
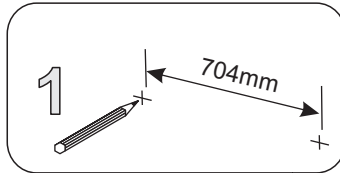
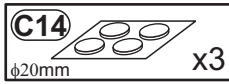

5

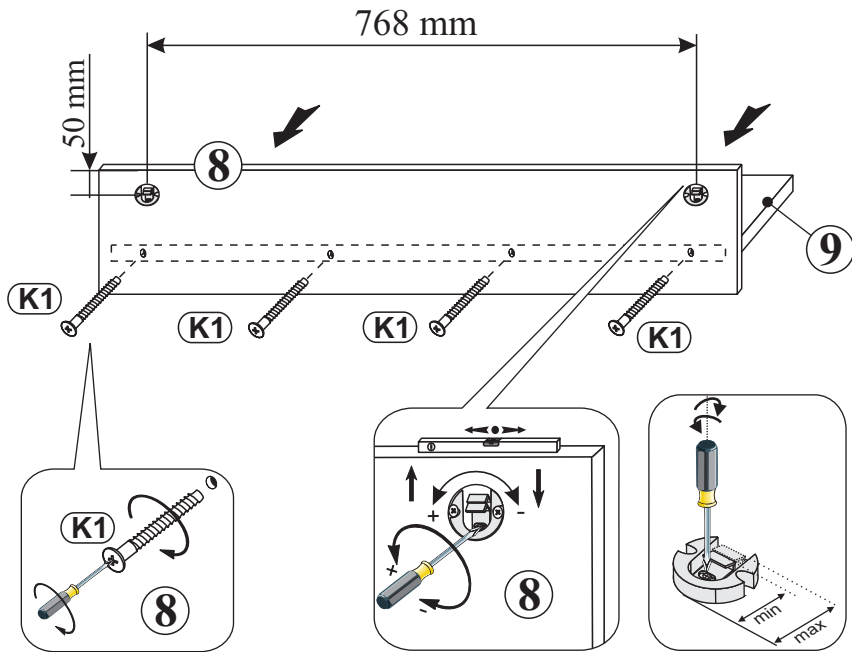
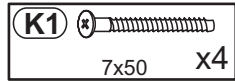

6

