

PRZED ROZPOCZĘCIEM MONTAŻU ZAPOZNAĆ SIĘ Z INSTRUKCJĄ  
 READ THE INSTRUCTION CAREFULLY BEFORE ASSEMBLING

## 2. szafa narożna

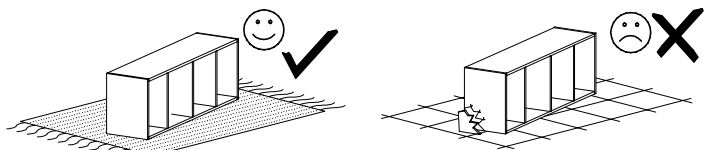

MONTOWAĆ NA MIEKKIM PODŁOŻU TYPU: KOC, DYWAN.  
 ASSEMBLE ON SOFT SURFACE LIKE A CARPET OR BLANKET

Elementy drewniane oraz miejsca styku tych elementów z płytą laminowaną czyścić tylko miękką szmatką. Chronić przed wilgocią.

Wood components and contact points of the elements with the laminated plate cleaned only with a soft cloth. Protect from moisture.

Narzędzia niezbędne do montażu  
 (nie dostarczane przez producenta)

Tools required for assembly  
 (not provided by the manufacturer)

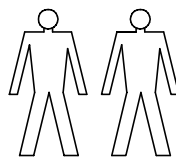
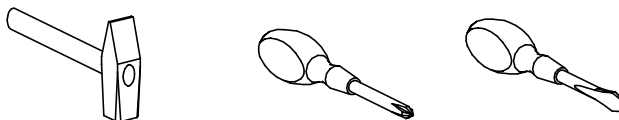

W PRZYPADKU REKLAMACJI PROSZĘ OZNACZYĆ  
 NUMER SERII OPISANY NA ETYKIECIE OPAKOWANIA

IN CASE OF COMPLAINT PLEASE INDICATE THE SERIAL  
 NUMBER DESCRIBED ON THE PACKAGE LABEL.

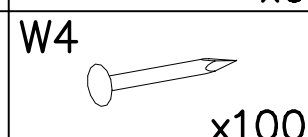
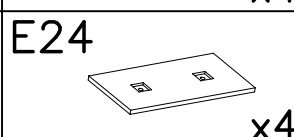
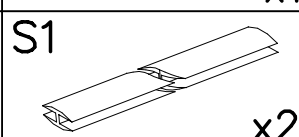
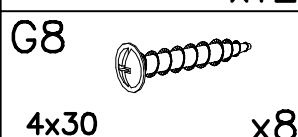
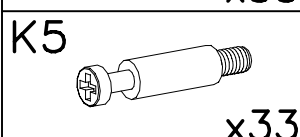
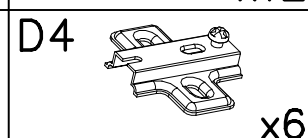
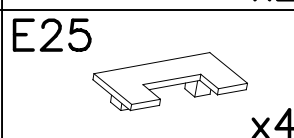
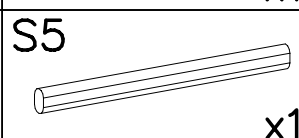
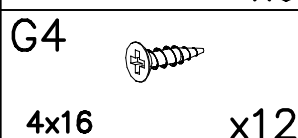
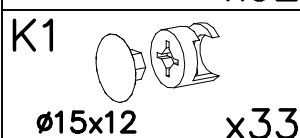
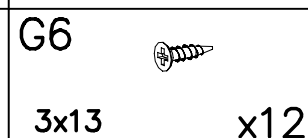
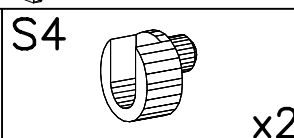
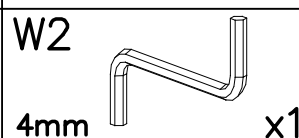
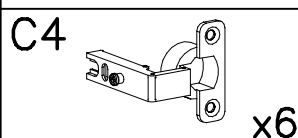
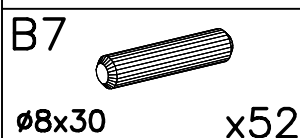
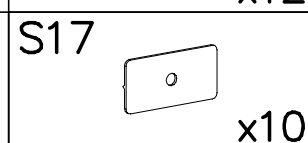
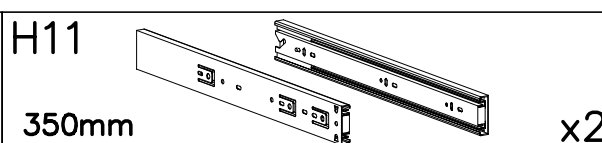
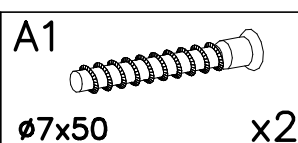
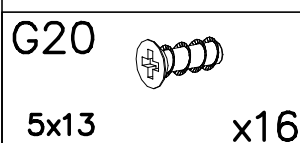
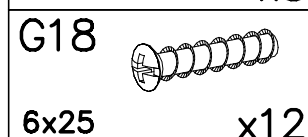
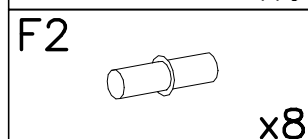
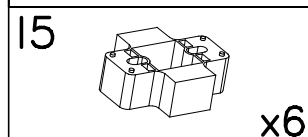
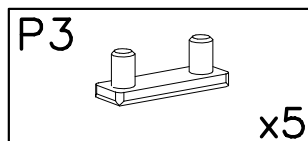
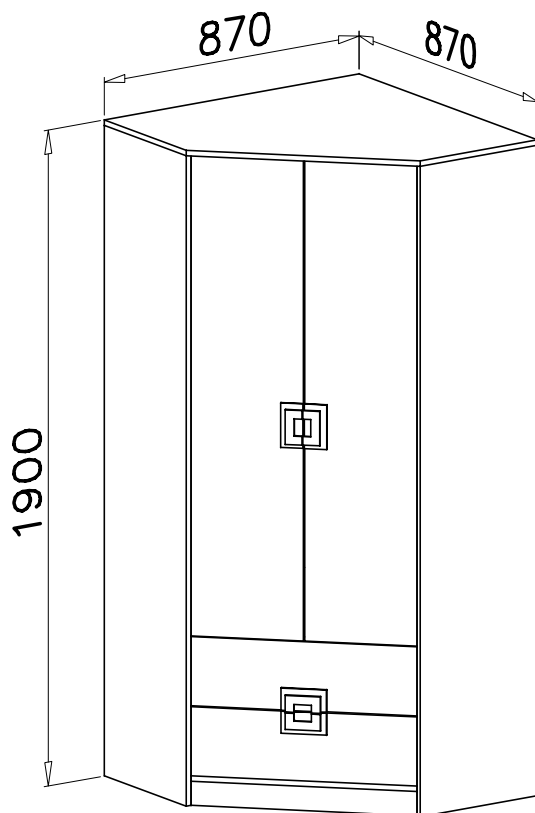

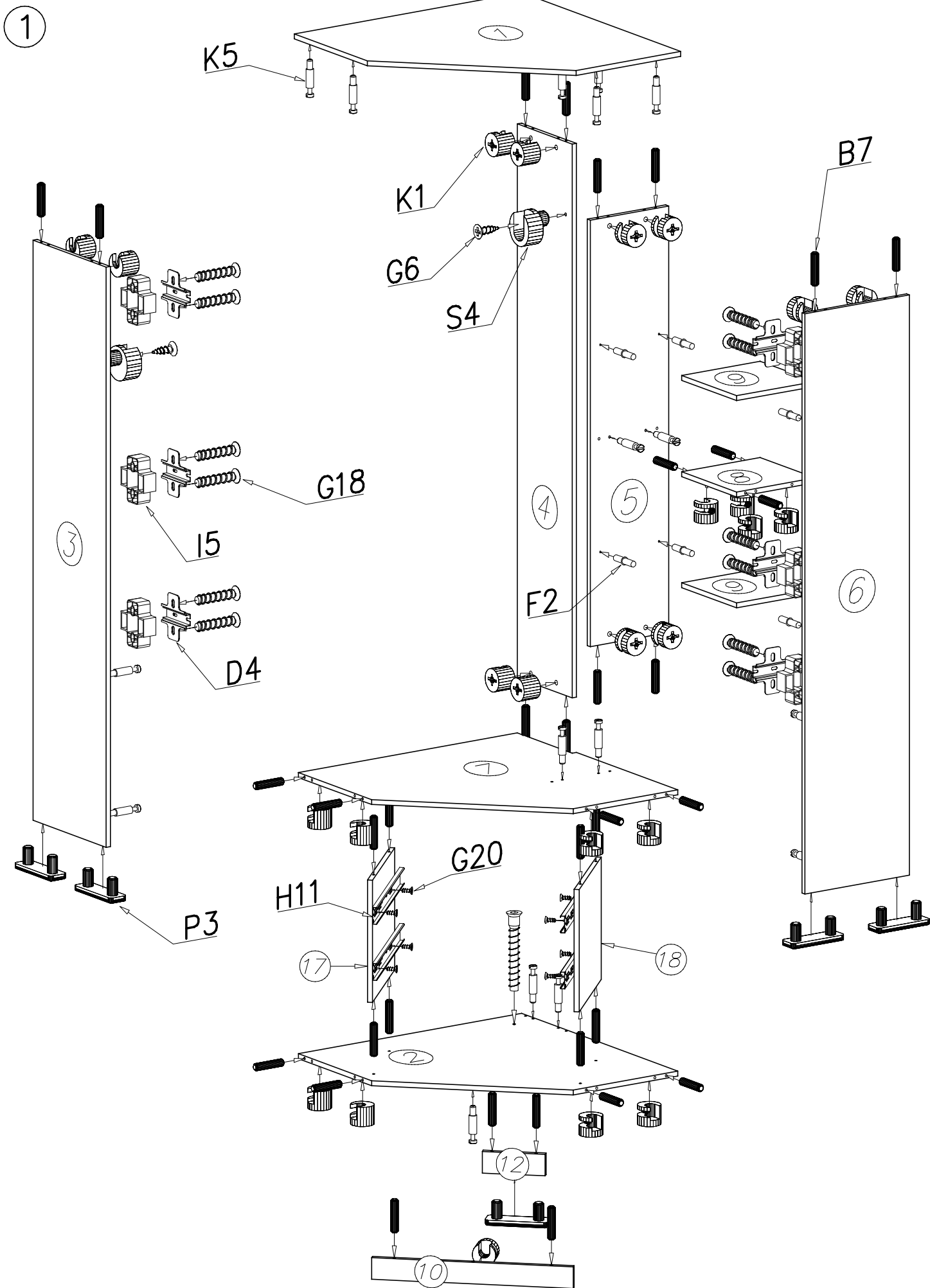

**UWAGA**

Kotki nabijać w zaznaczone strzałkami miejsca. Pins to tap the space indicated by arrows

**ATTENTION**

Długość wystającego kotka po wbiciu w otwór nie może przekraczać 9–10mm.  
The length of the projecting pin when pocketed does not exceed 9–10 mm

2

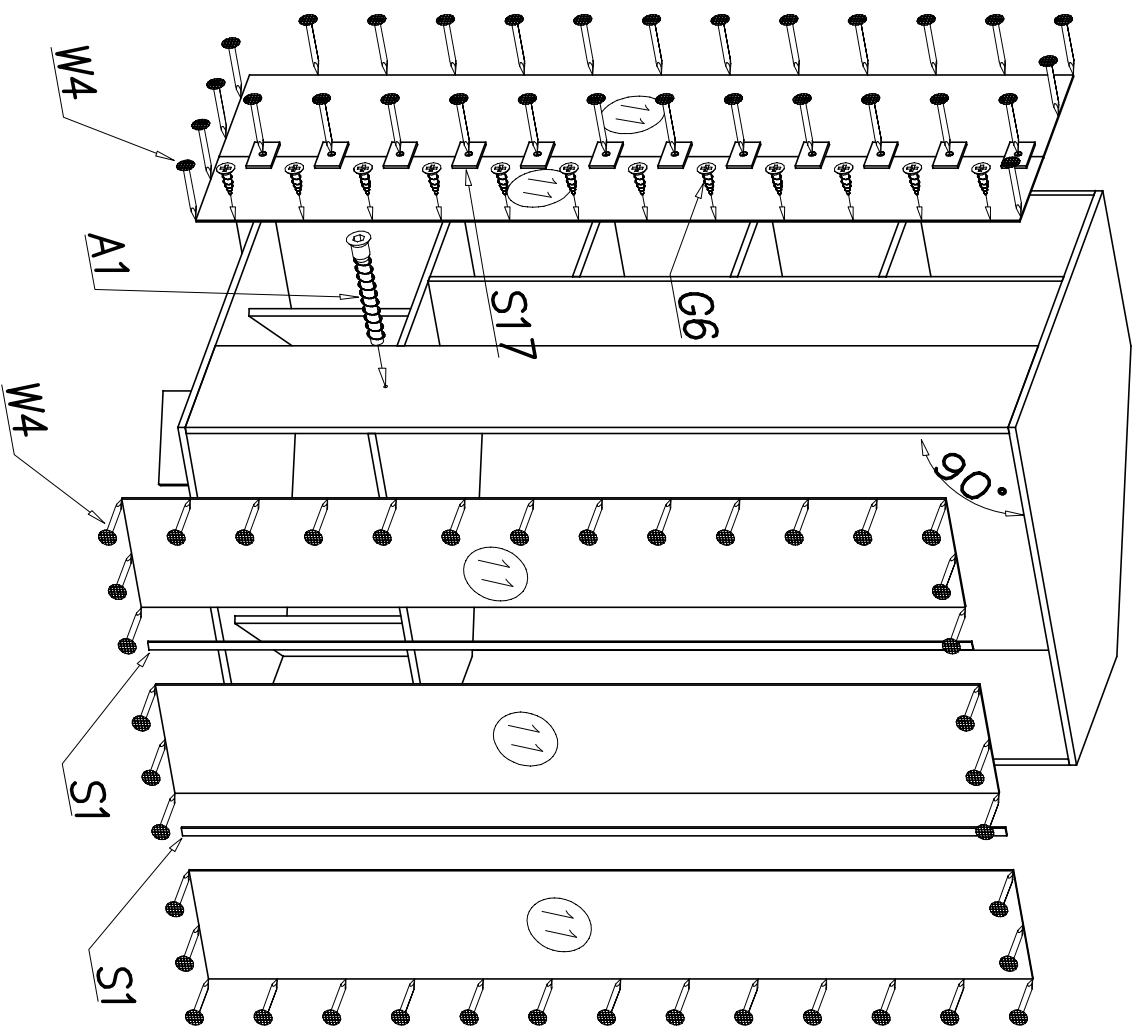

3

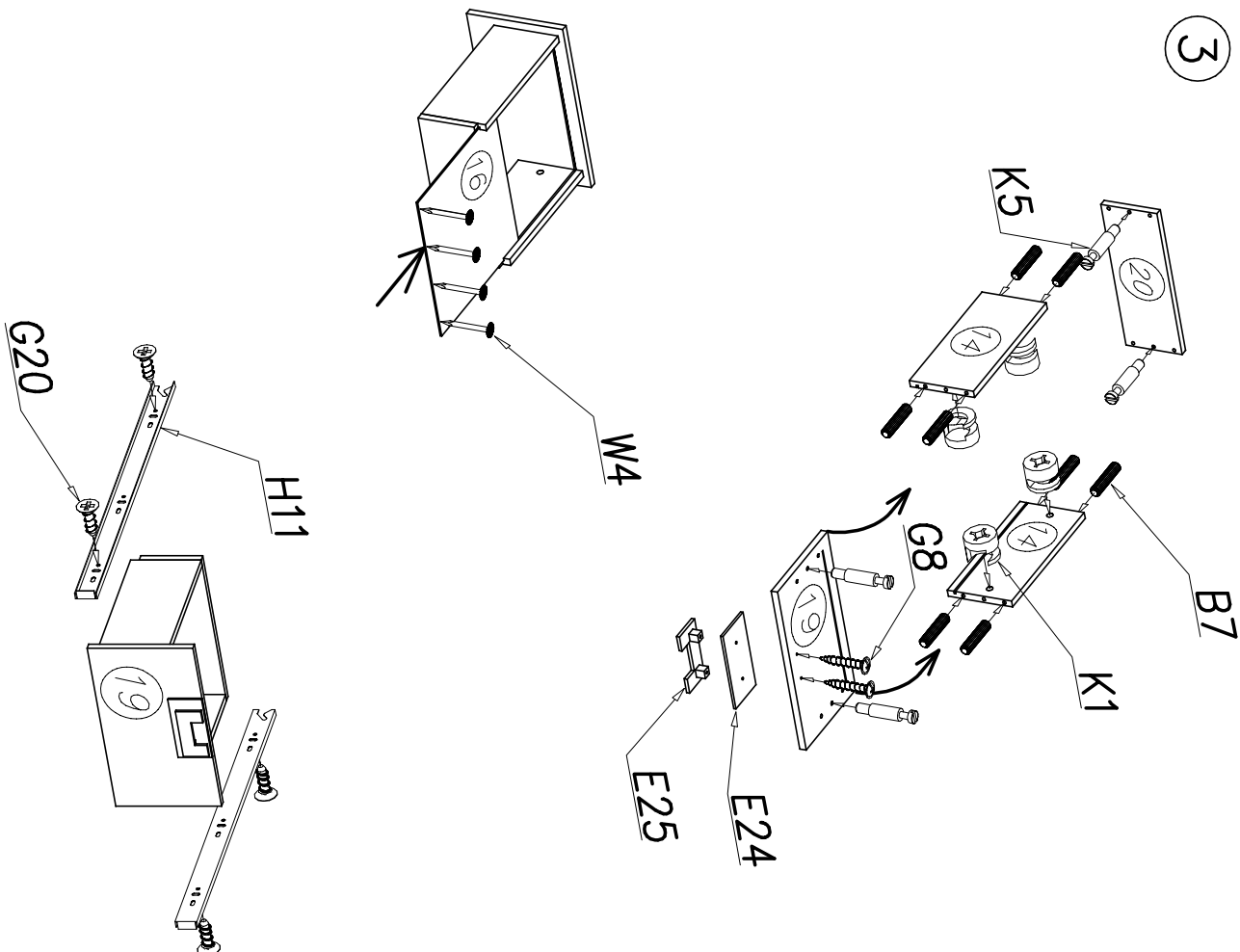

**UWAGA**

**ATTENTION**

Kotki nabijając w zaznaczone strzałkami miejsca. Pins to tap the space indicated by arrows

Długość wystającego kotka po wbitciu w otwór nie może przekraczać 9–10mm.

The length of the projecting pin when pocketed does not exceed 9–10 mm

4

