

# RUMBA 20

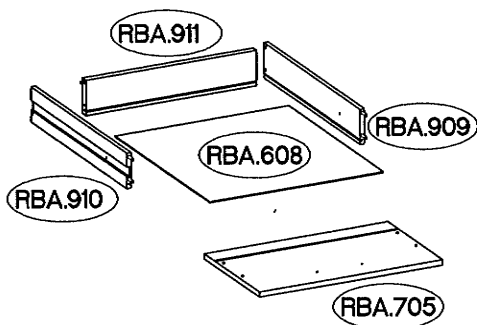
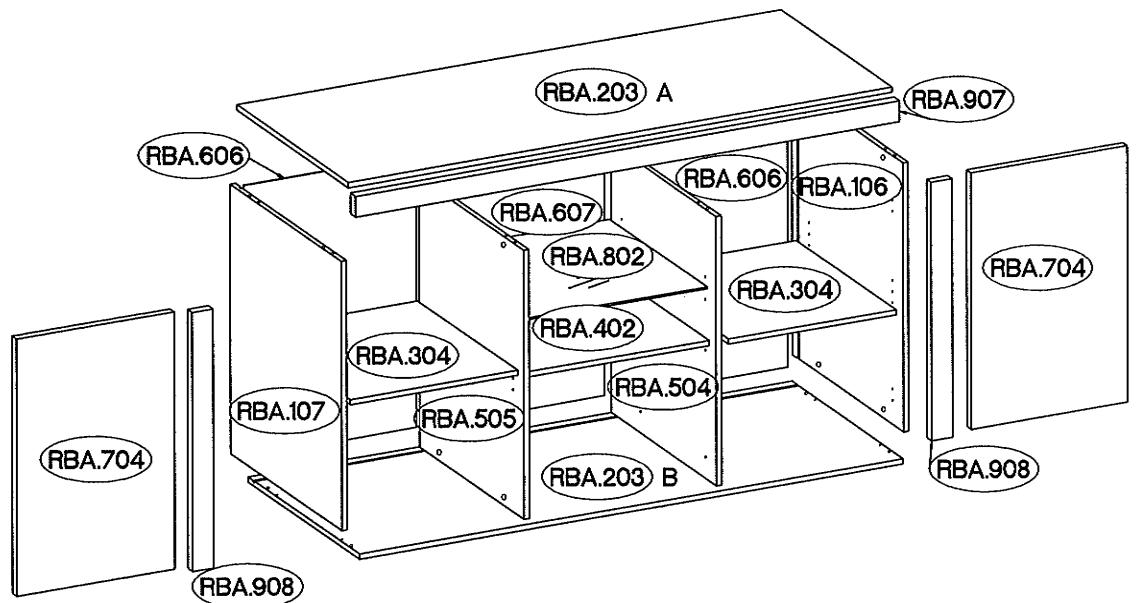
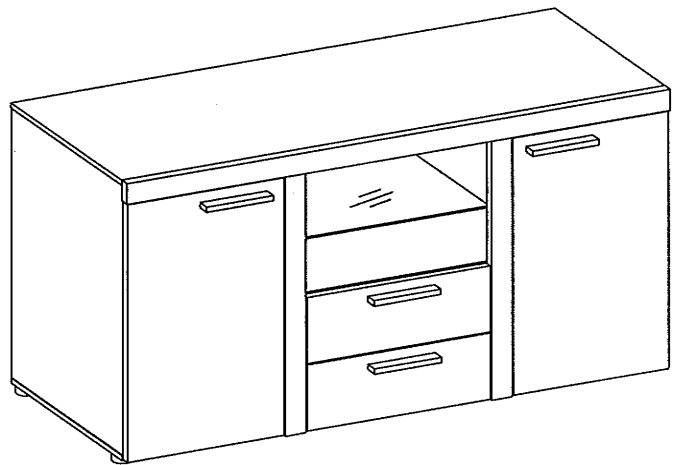

J14	O7	L9
8	2	2

M3	B2	T9	F10	P14
8	4	9	6	6

L2	P5	P1	R2	J12	U1	O1	I	T4
10	10	26	8	4	4	1	2	2

E	H	P7	D2	C	A	L	S1	J3	G
16	4	13	20	20	16	14	4	8	4

1

310/27mm  I 2	 T4 2	+8x30mm  A 16	+15/12mm  C 20	L=20mm  D2 20	+6,3x20mm  M3 8	 F10 6	+4.0x25mm  P14 6	+4.0x16mm  P1 13
 T9 9	+20/8mm  J14 8							

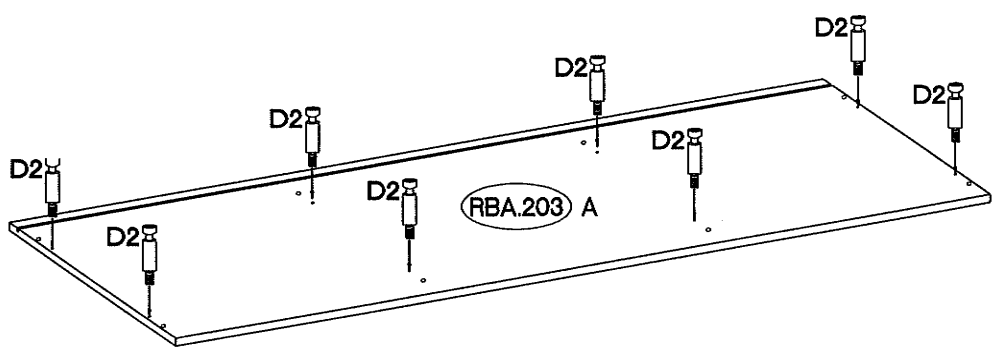
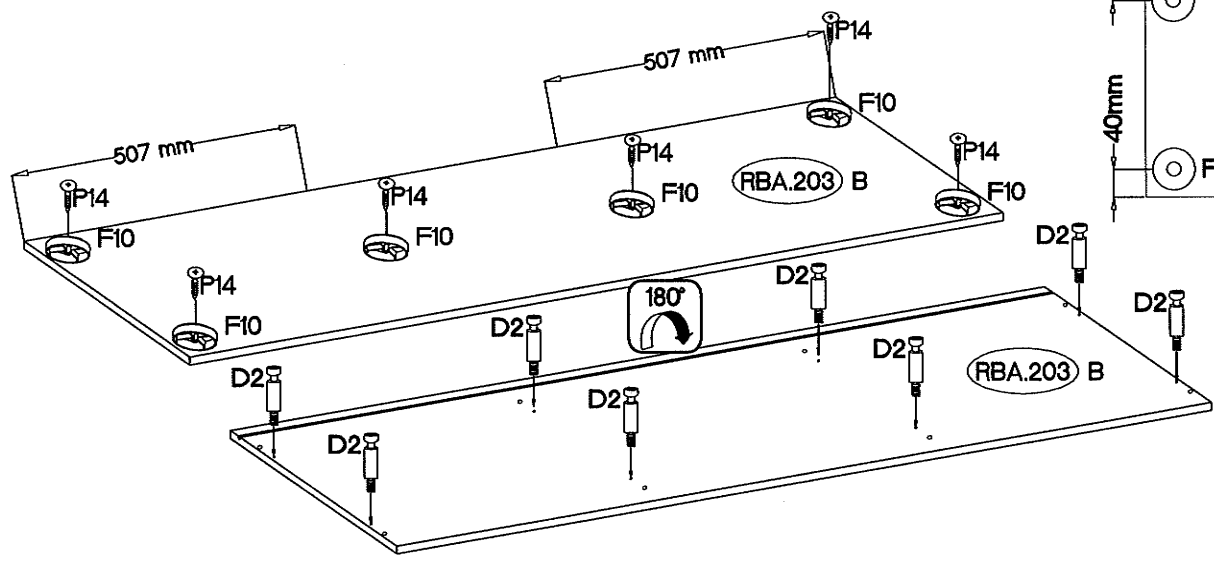
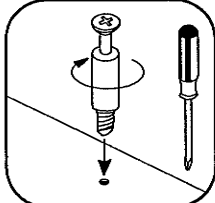
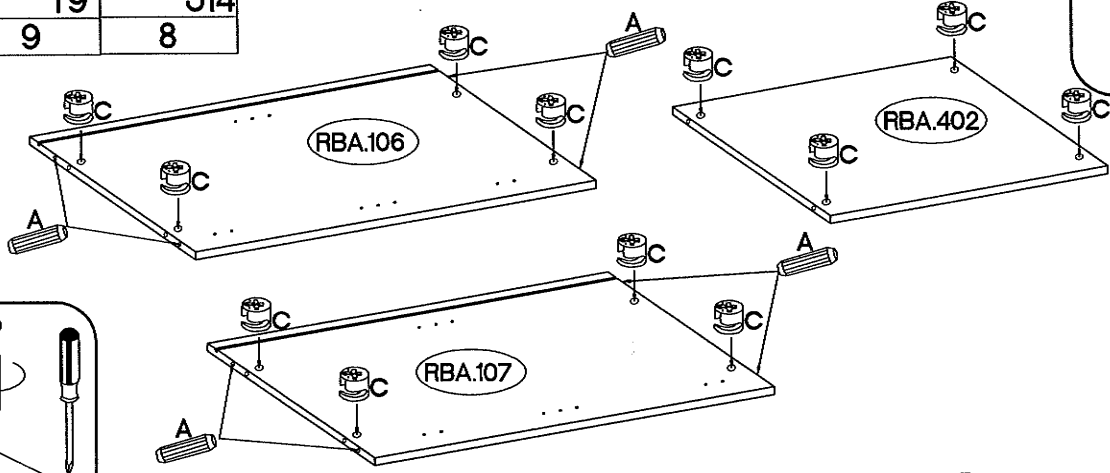
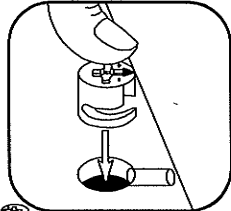

1

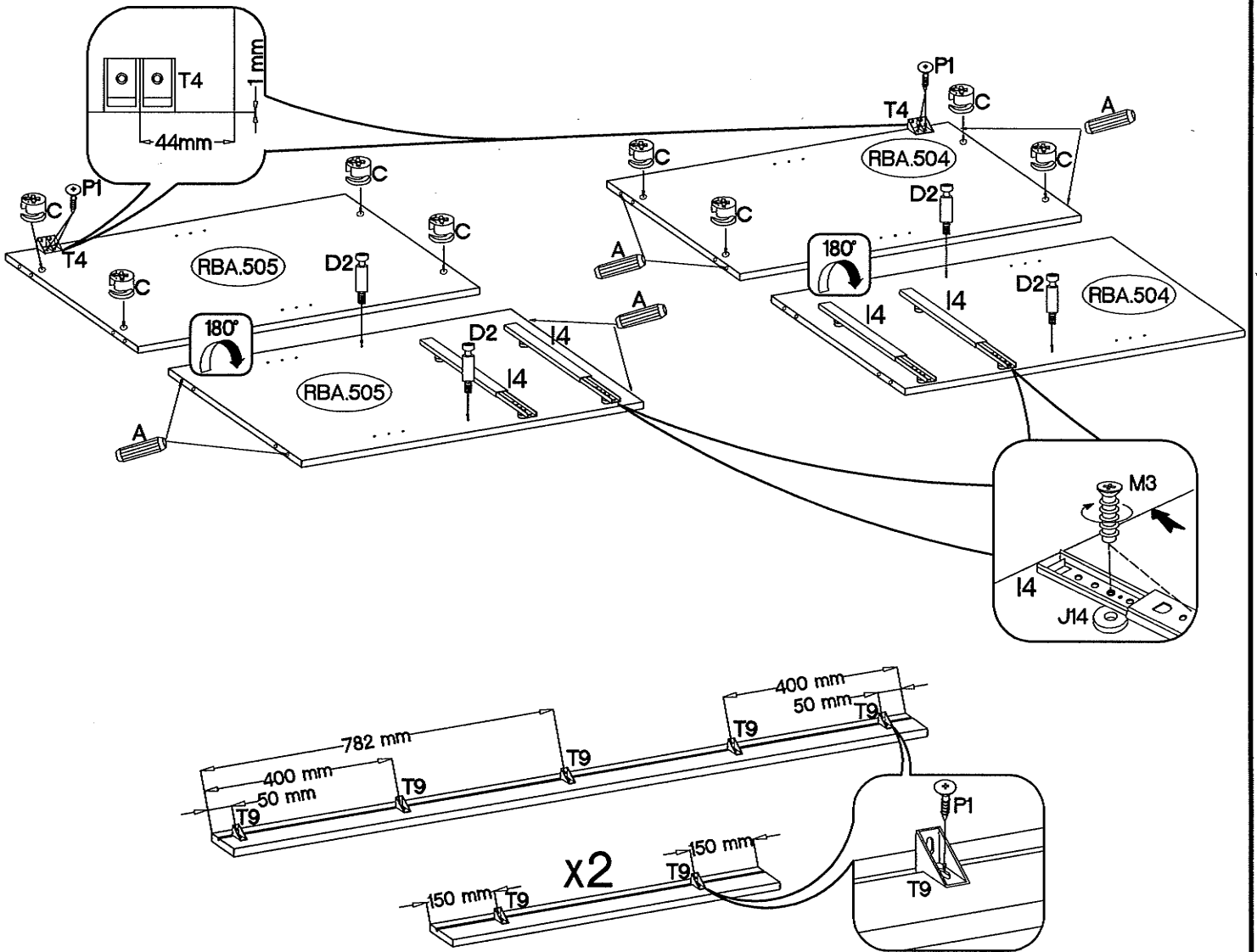

2

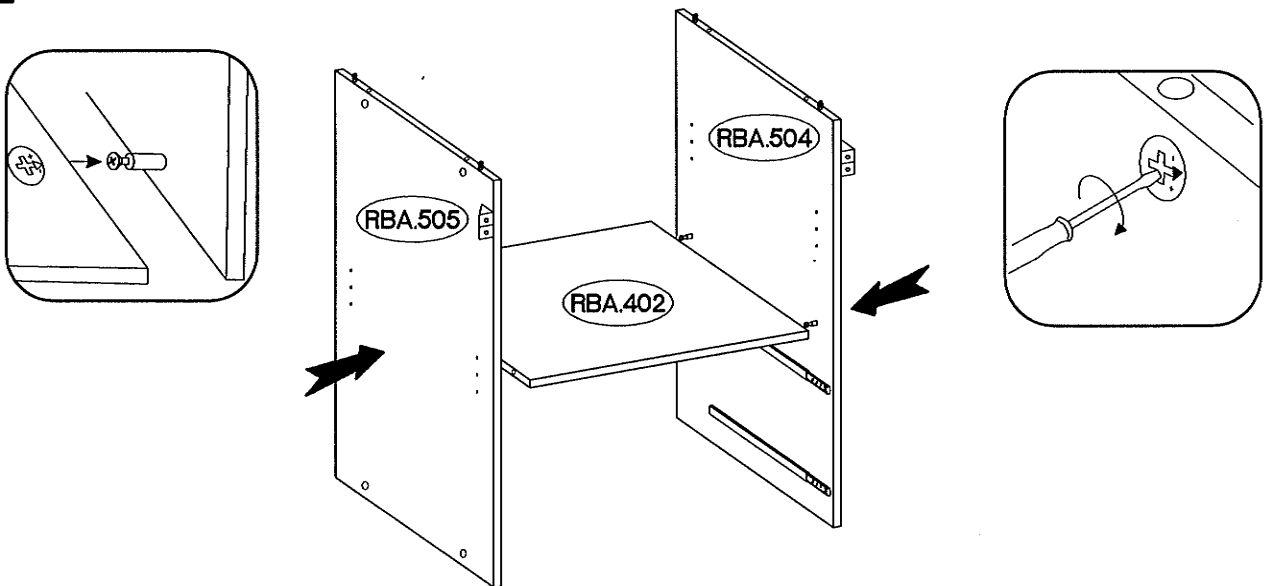

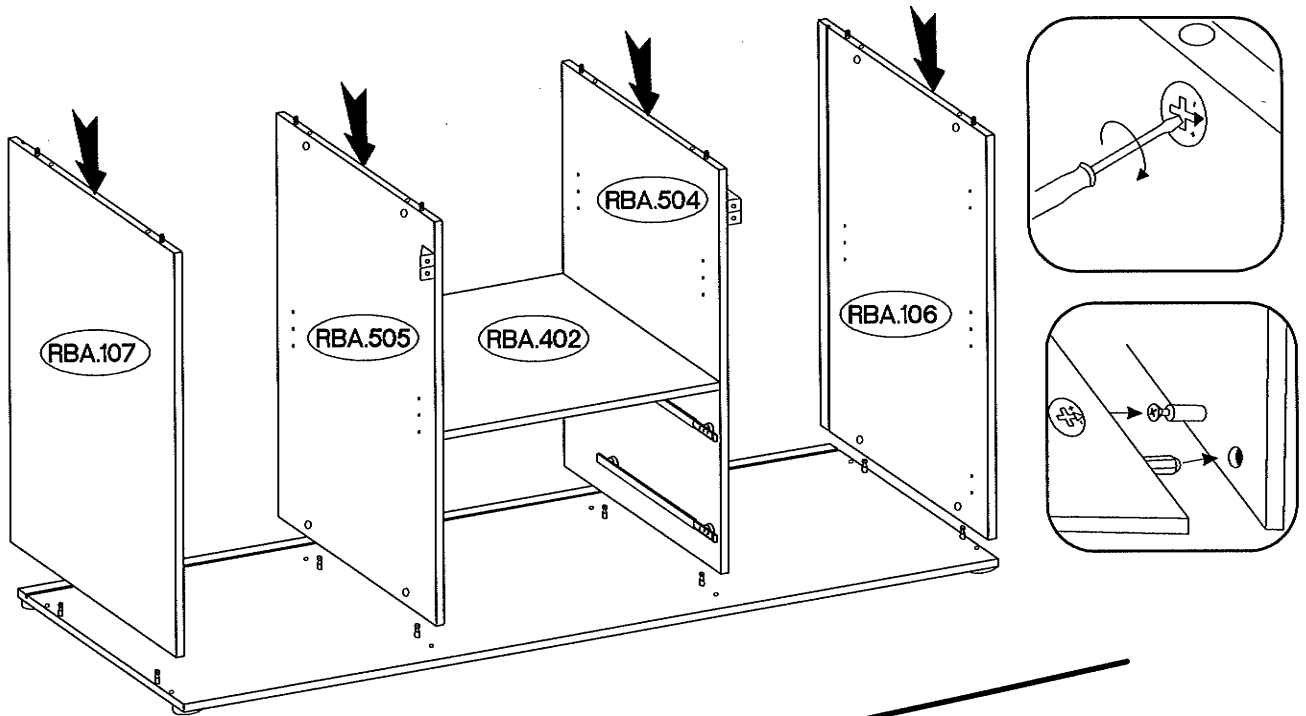

3

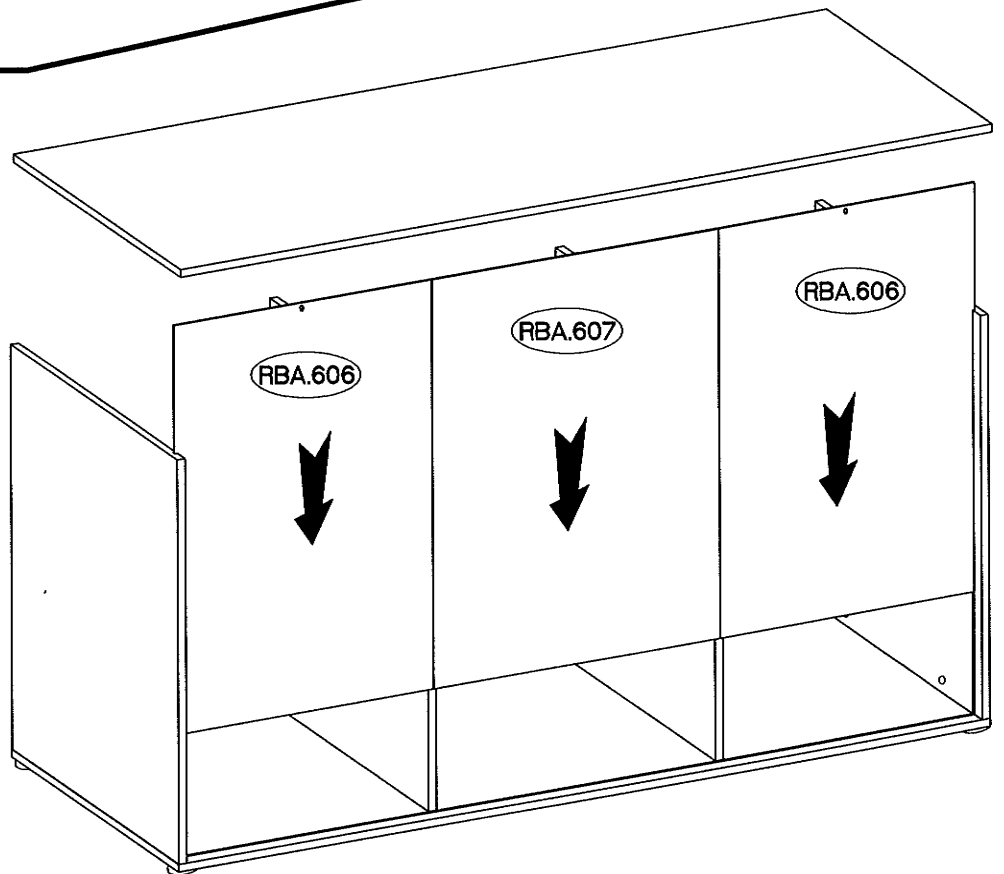
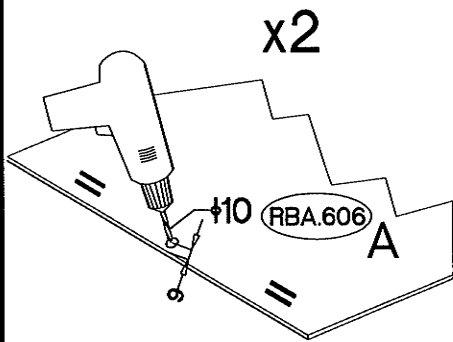

4



# 5

±3.0x20mm			
	P7	L2	L
	13	10	10

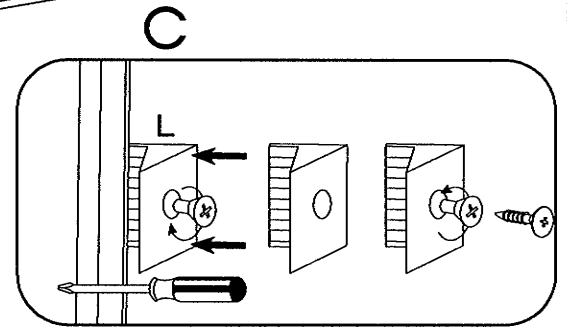
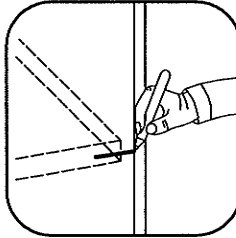
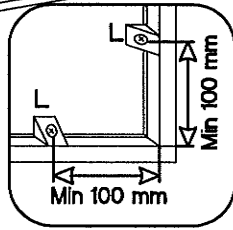
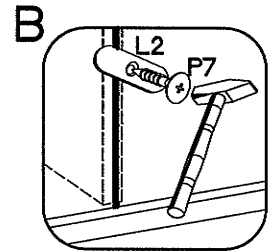
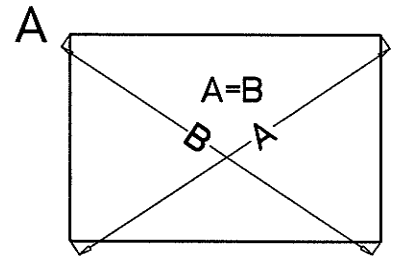
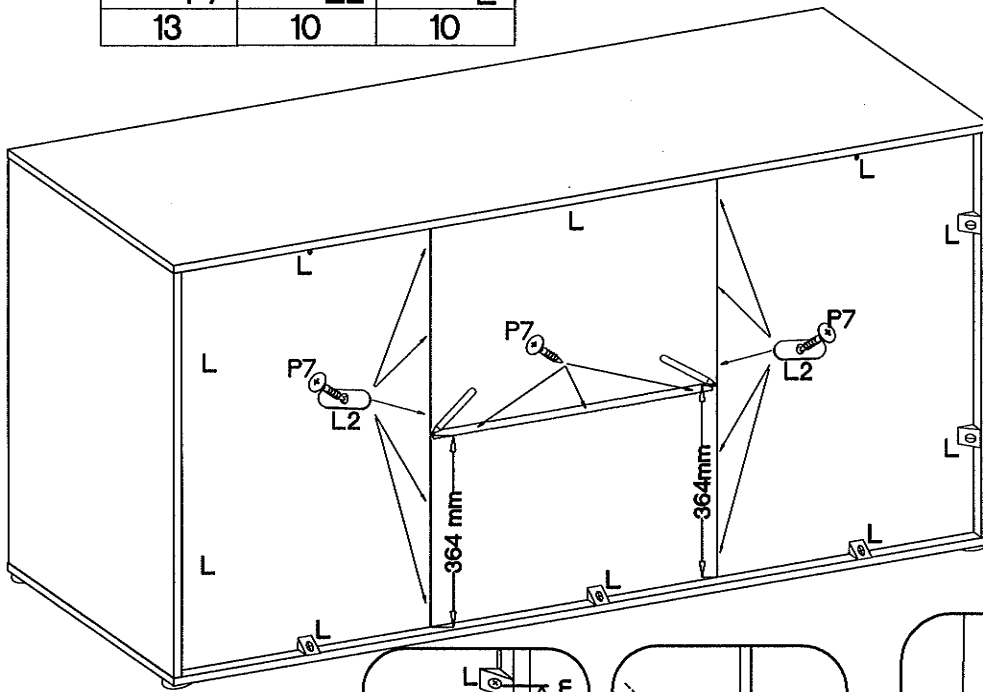

# 6

±4.0x16mm	
	P1
	13

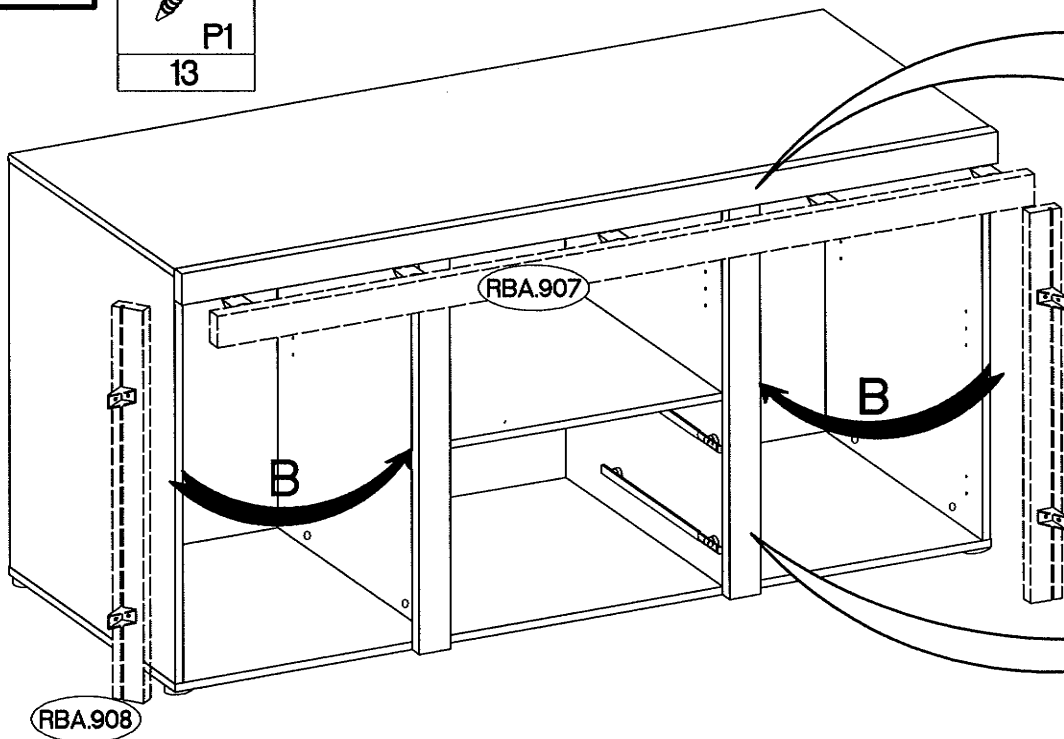

x2

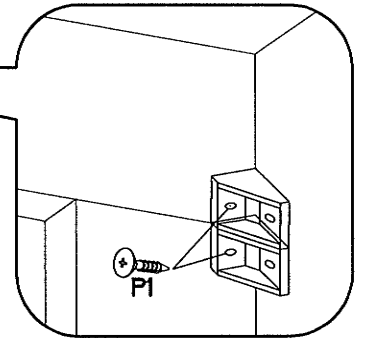

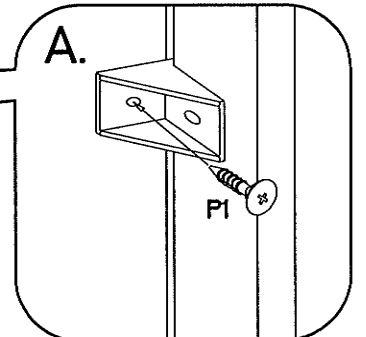

x9



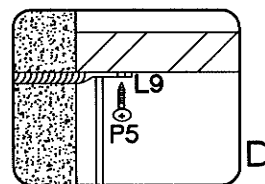
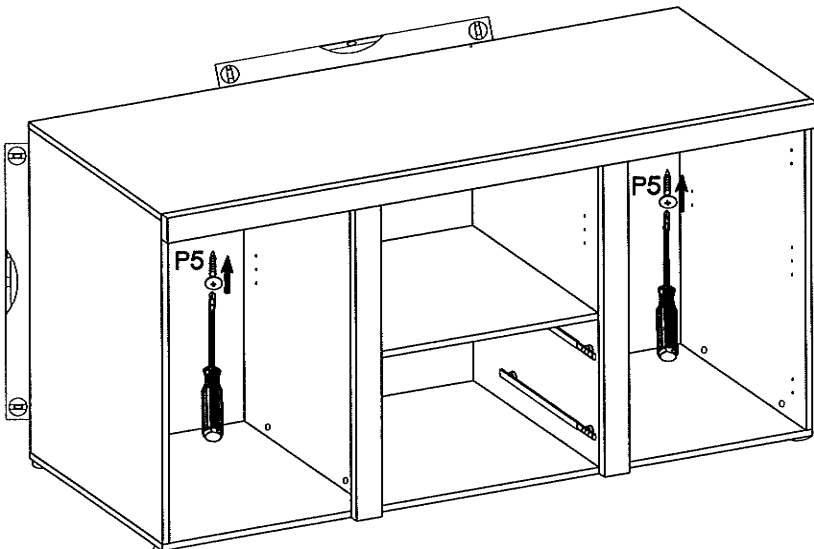
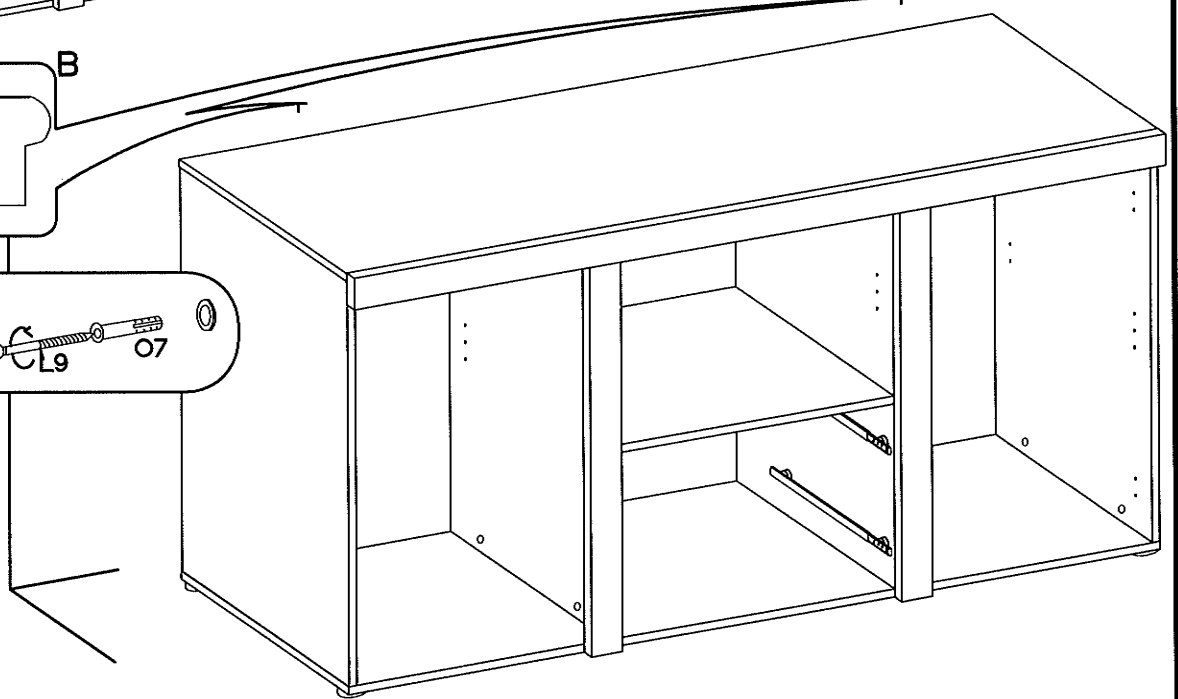
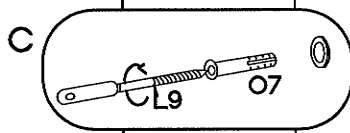
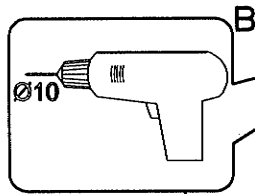
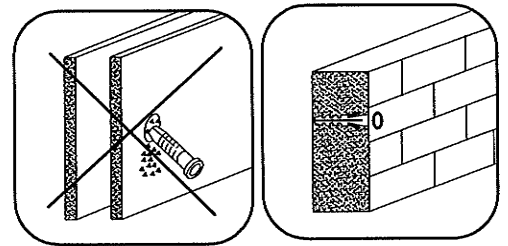
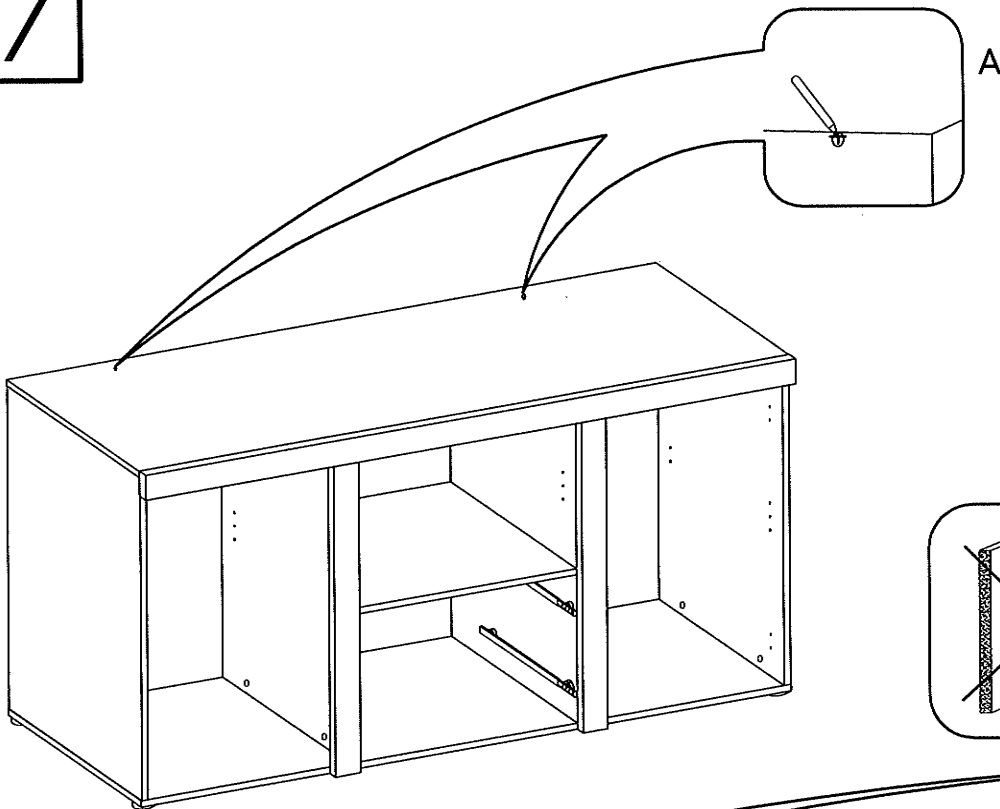



7



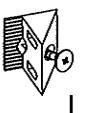

†10x50mm		†3.5x13mm
		
O7	L9	P5
2	2	2

8

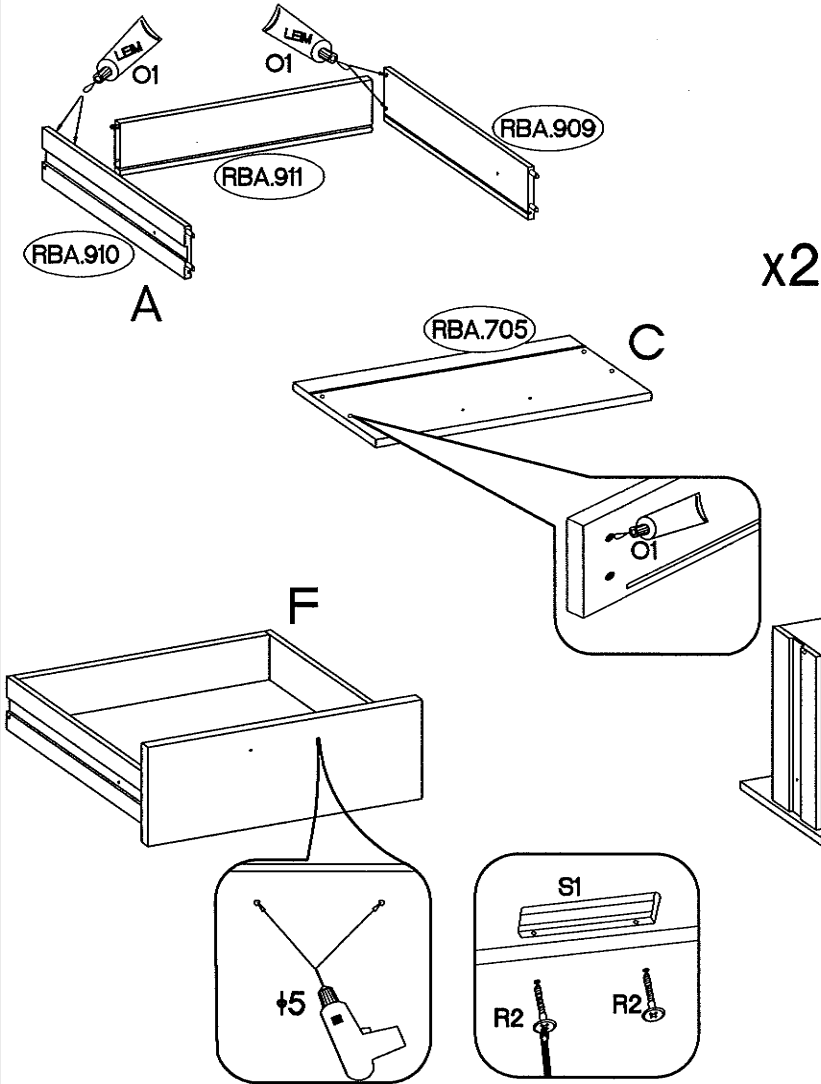
$\pm 6 \times 42 \text{mm}$  B2 4	 O1 1	L=128mm  S1 2	$\pm 4.0 \times 30 \text{mm}$  R2 4	 L 4
---	--	---	---	---



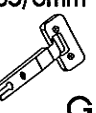



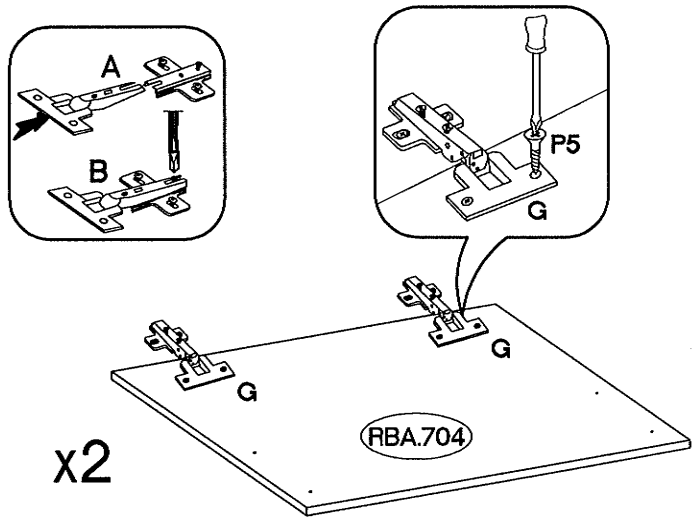

9

H=0  H 4	$\pm 35/0 \text{mm}$  G 4	$\pm 3.5 \times 13 \text{mm}$  P5 8
--	---	---

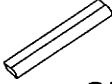

# 10

±5/16mm  J3	 J12	L=128mm  S1	±4.0x30mm  R2	M4x9mm  U1	 E
8	4	2	4	4	16

