

MODENA

REGAŁ 55

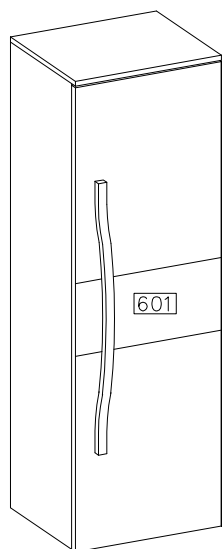

4

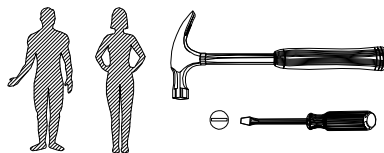

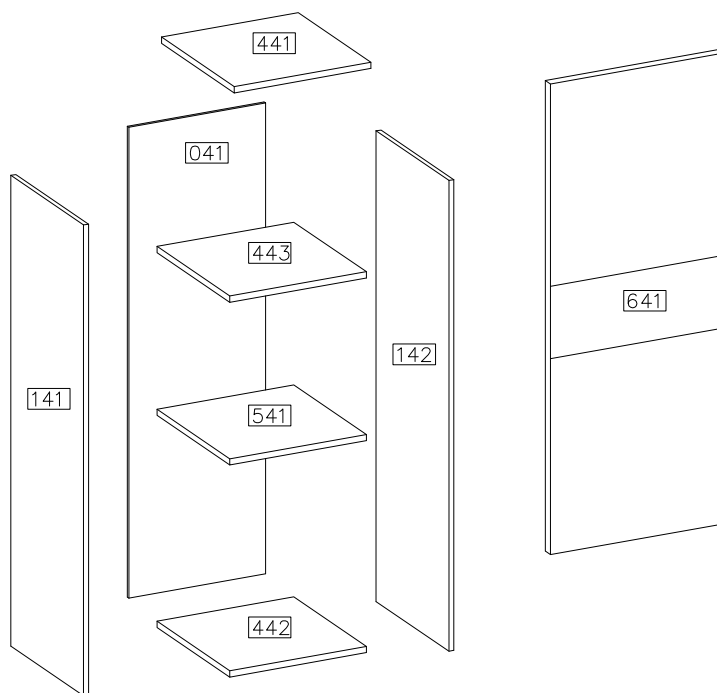
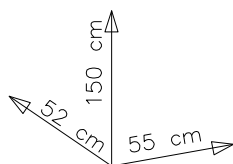
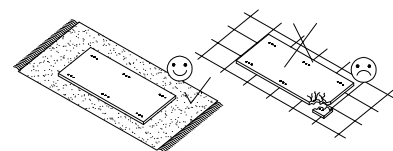
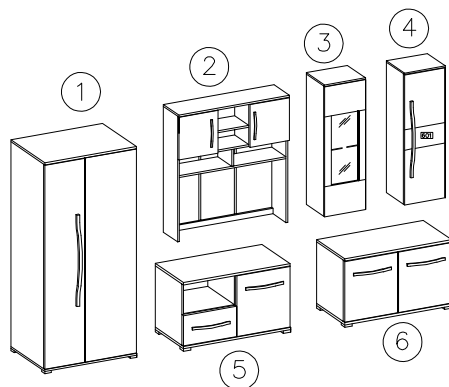

#	ART. NR	QUANTITY
1	441	1
2	442	1
3	443	1
4	141	1
5	142	1
6	041	1
7	641	1
8	541	1



D1	$\varnothing 15/12\text{mm}$ C	E	$\varnothing 8 \times 30\text{mm}$ A	H=0 H4	$\varnothing 35/\text{KR}-0$ G6	$\varnothing 4.0 \times 16\text{mm}$ P1
12	12	12	20	3	3	10
F10	B2	S1	$4.0 \times 27\text{mm}$ R2	J4		
30	2	1	4	4		



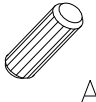

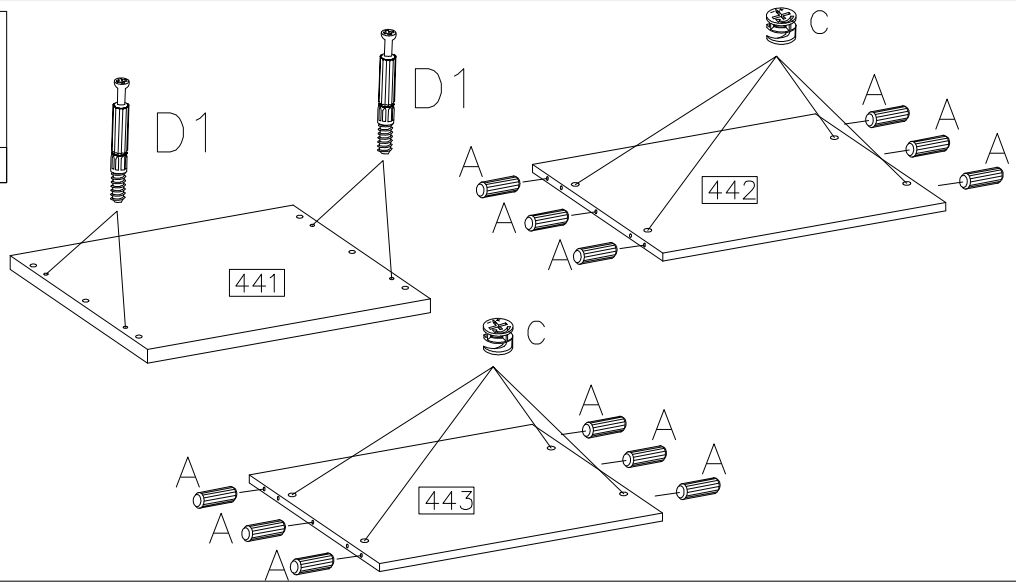
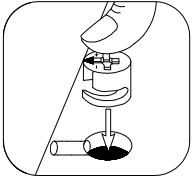

1

$\varnothing 8 \times 30 \text{mm}$	$\varnothing 15 / 12 \text{mm}$	
		
A	C	D1
12	8	4



2

	$\varnothing 15 / 12 \text{mm}$
D1	
8	C
H=0	$\varnothing 8 \times 30 \text{mm}$
	
H4	A
3	6
	
J4	
4	

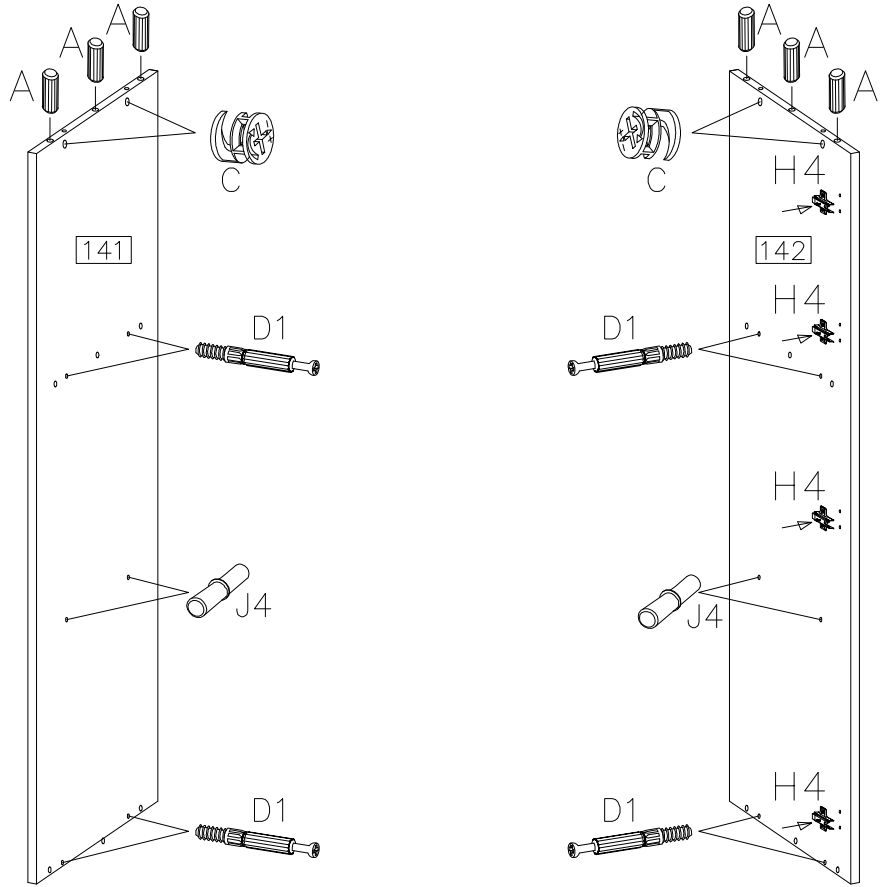
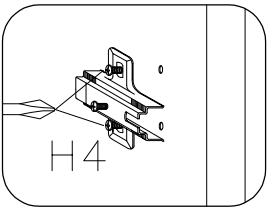

3

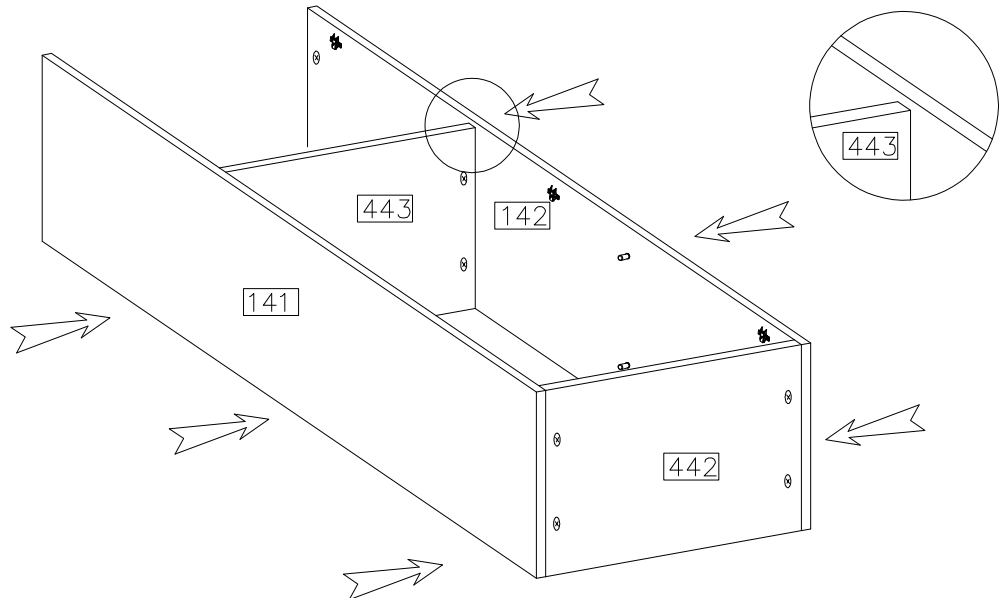
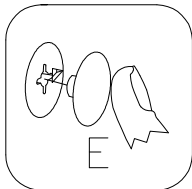
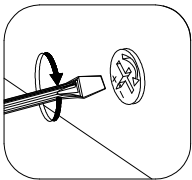

E
8

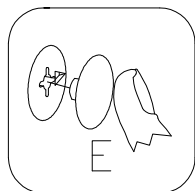
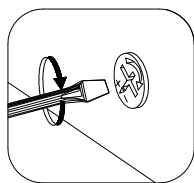
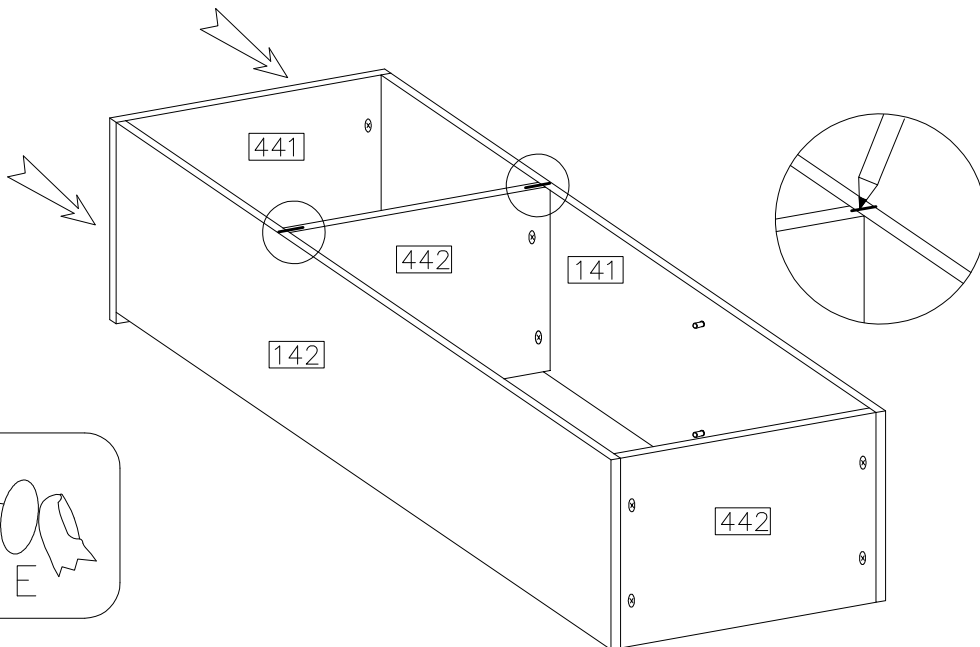
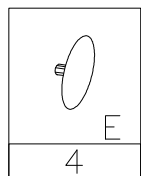

4

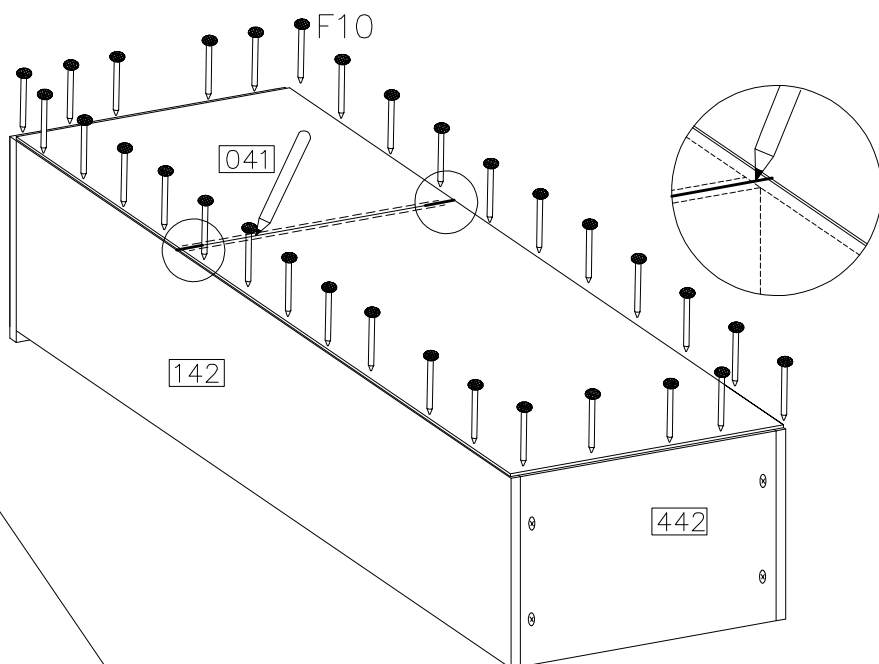
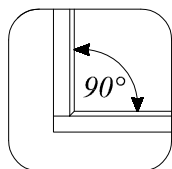
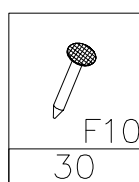

5



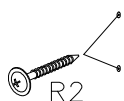
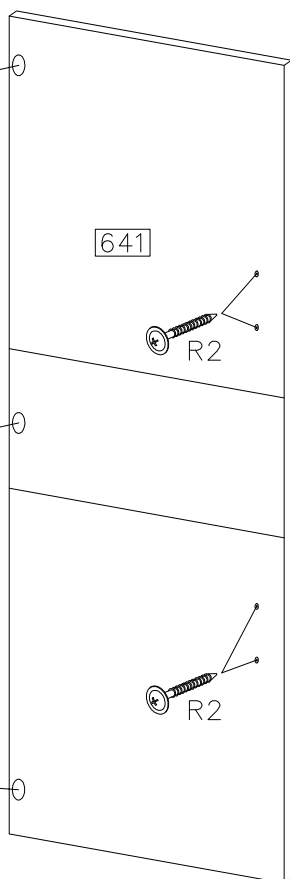
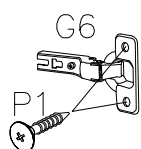

6



S1

$\varnothing 35/KR-0$	$\varnothing 4.0 \times 16mm$
G6	P1
3	6
	4.0x27mm
S1	
1	4

7

∅8x30mm 	4.0x16mm 	
A	P1	B2
2	4	2

