

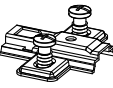









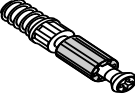
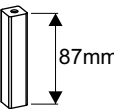
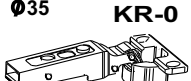











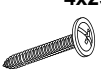

 15x12 12x T02	 4x S10	 4x Z21	 2x R10
 12x T01	 87mm 2x N07	 Ø35 4x Z22	 3x13 12x W08
 8x28 16x D01	 2x S11	 3,5x16 8x W01	 2x F01
 Z4 1x K03	 M5-20 2x N08	 2x S42	 2x P01
 7x50 4x W15	 M5-20 6x NS1	 4x25 4x W28	 4x13 4x W07
 4x E01	 Z3 1x K02	 Ø20 6x C01	 5x70 2x F11
 6x N05	 4x16 24x W25	 Ø20 2x C03	 2x L6
 97mm 4x N06	 18x R01	 Ø60 1x C10	

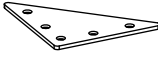
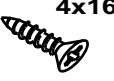

NR	DIM	QTE	COLLI
1	402x292x15	1	1/1
2	274x401x15	1	1/1
3	274x401x15	1	1/1
4	402x292x15	1	1/1
5	1550x420x18	1	1/1
6	493x340x15	1	1/1
7	1518x401x18	1	1/1
8	512x286x15	2	1/1
9	293x507x2	1	1/1
10	293x507x2	2	1/1

0 10 20 30 40 50 60 70 80 90 100 110 120 130 140 150 160 170 180 190 200

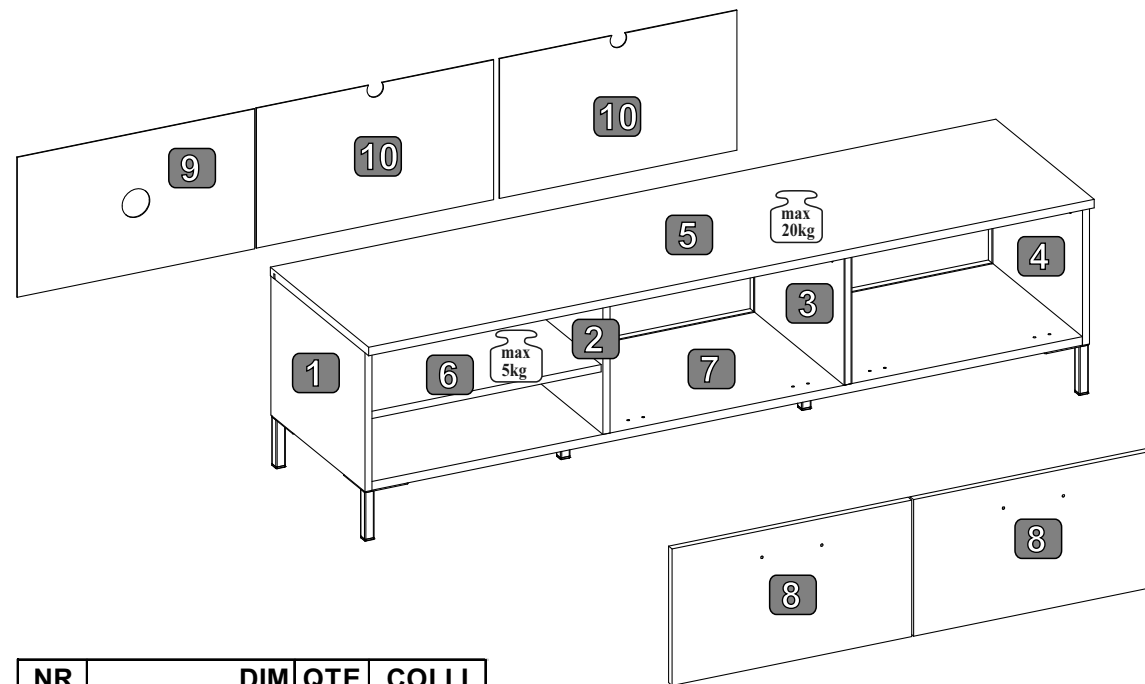

1

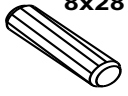
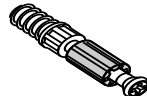
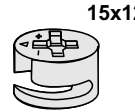
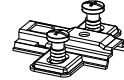
 8x28 12x D01	 8x T01	 15x12 8x T02	 4x Z21
--	---	--	---

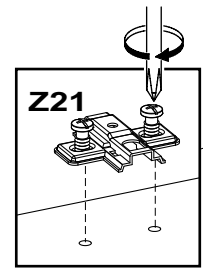
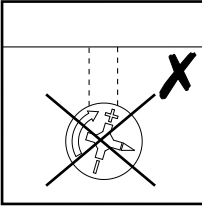
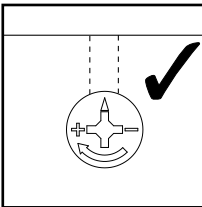
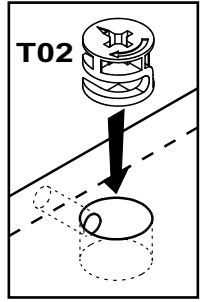
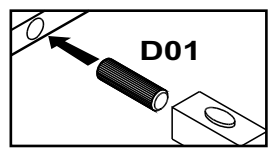
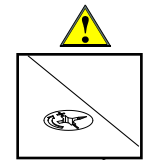

7

7

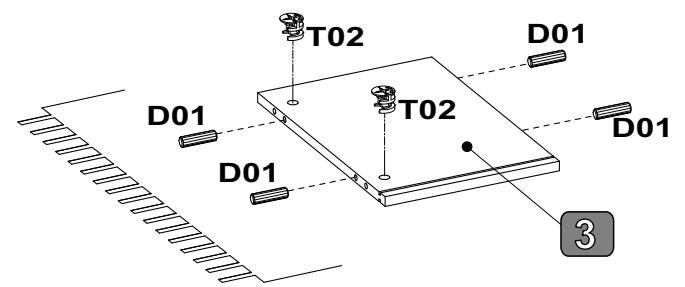
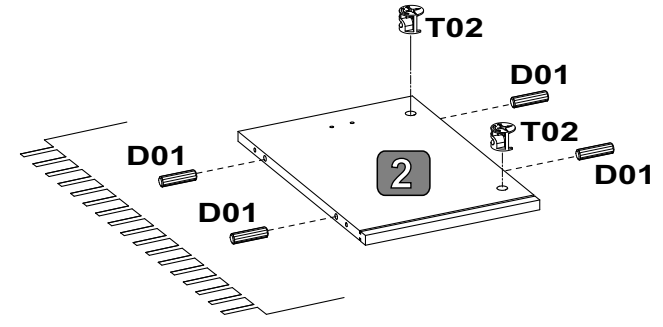
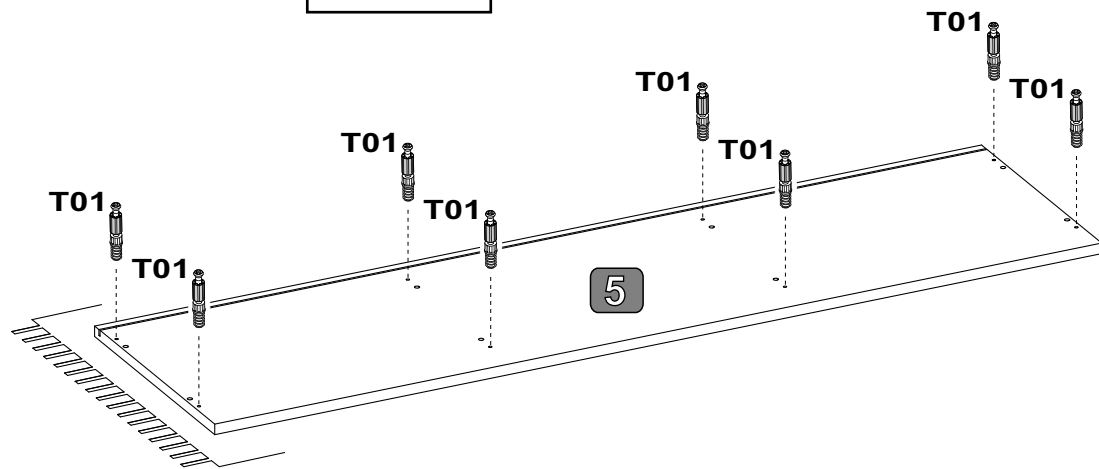
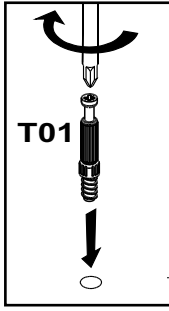
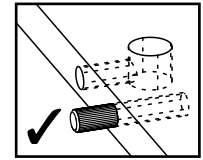
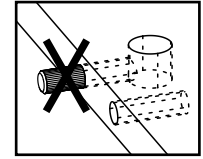

2

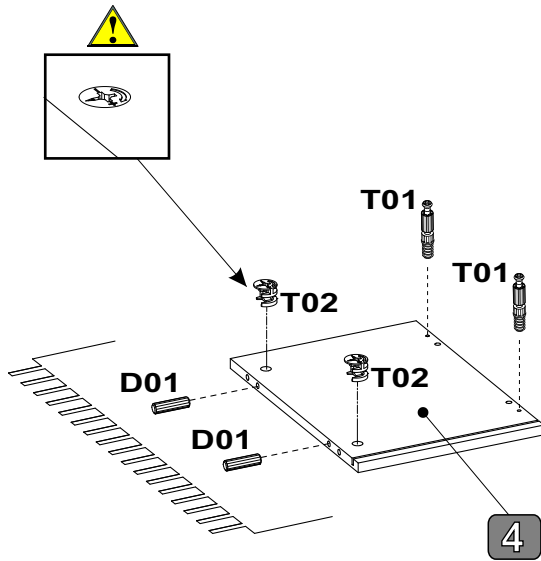
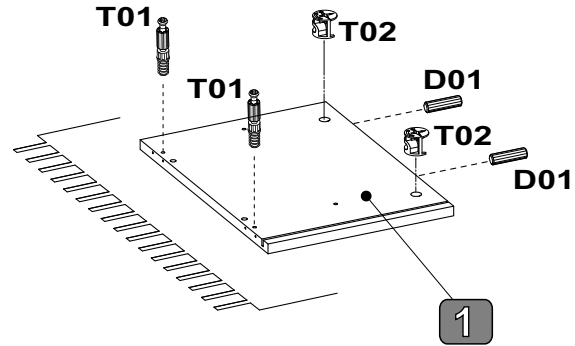
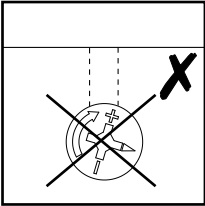
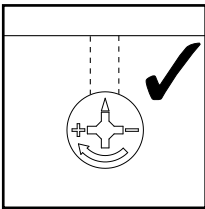
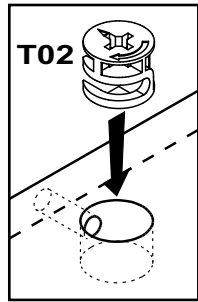
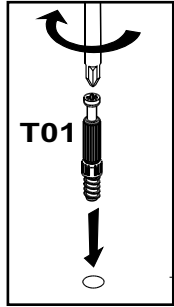
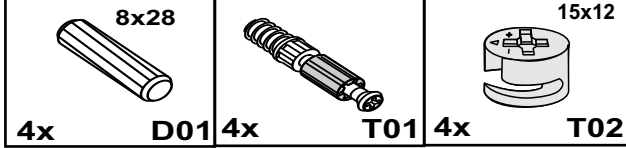

3

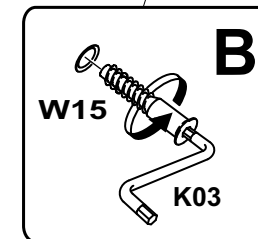
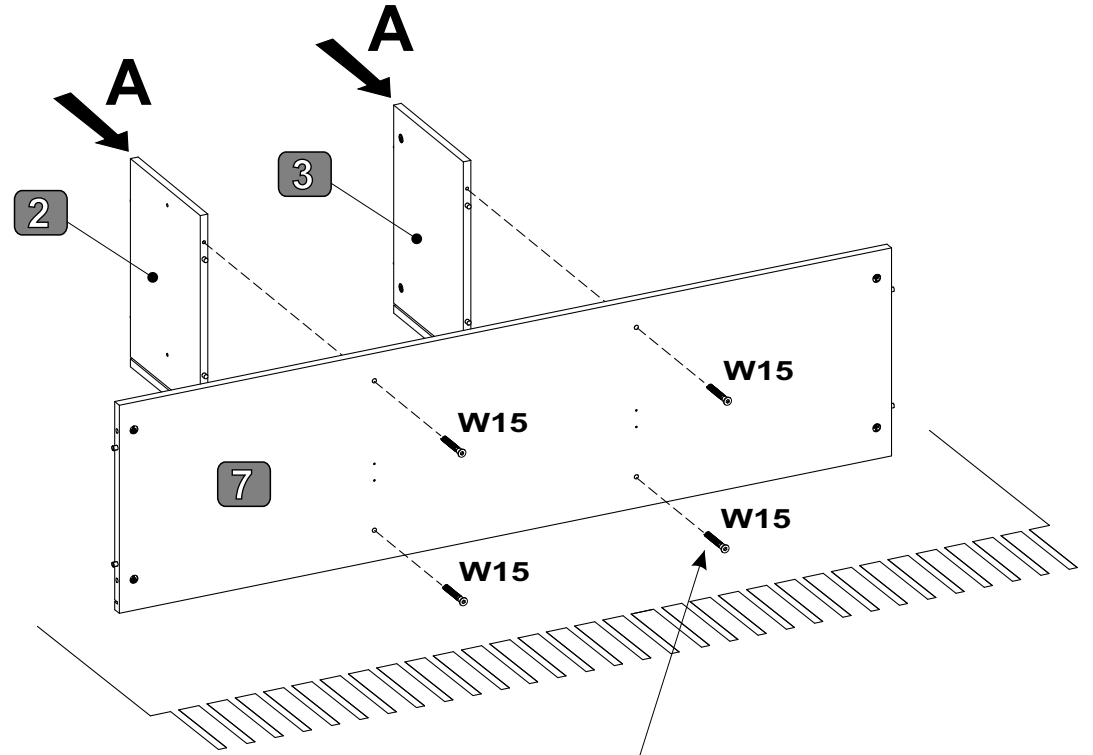
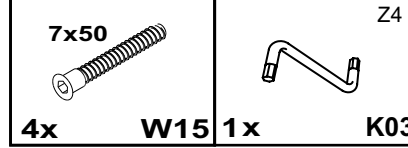

4

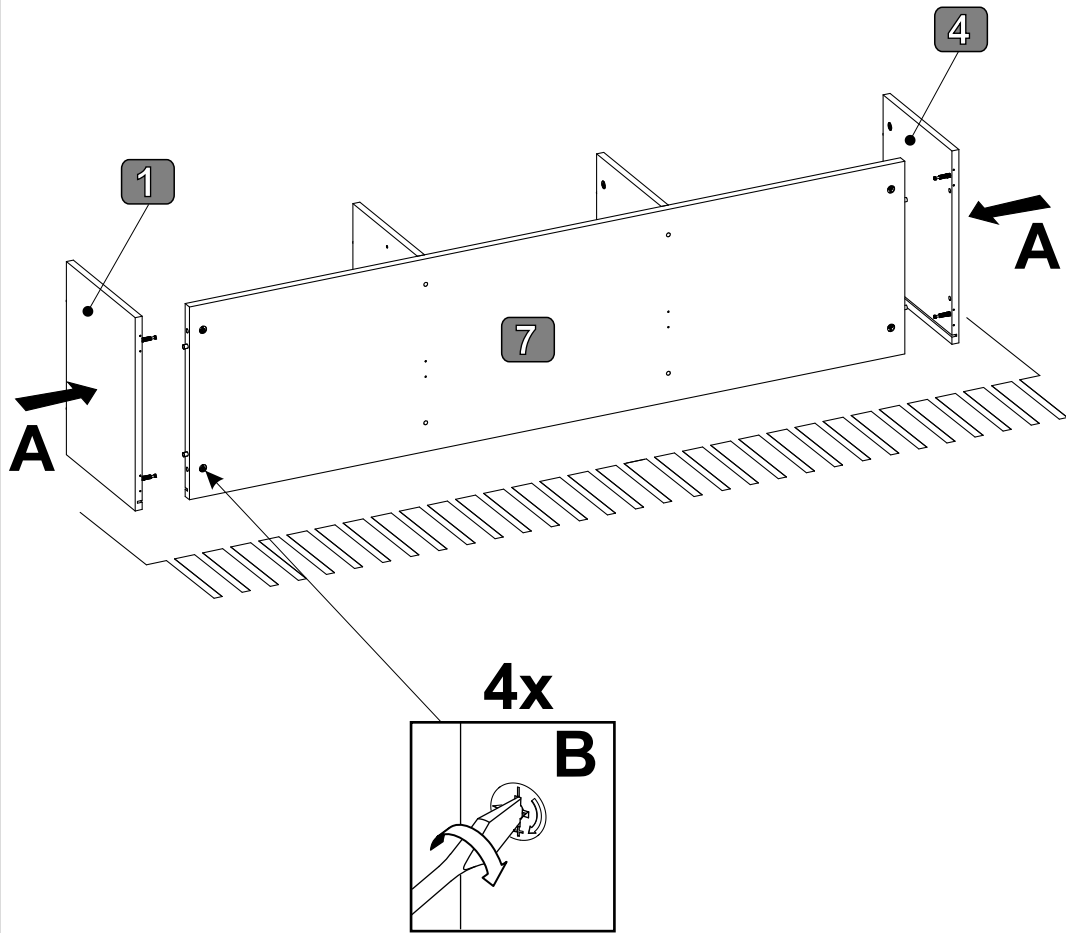

5

4x N06	97mm 	4x S10		4x NS1	M5-20 	4x N05	
1x K02	Z3 	16x W25	4x16 				

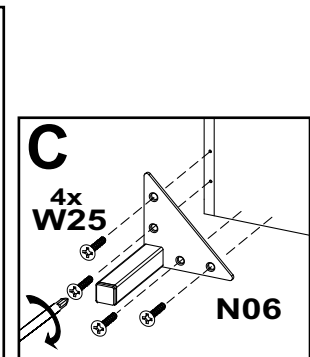
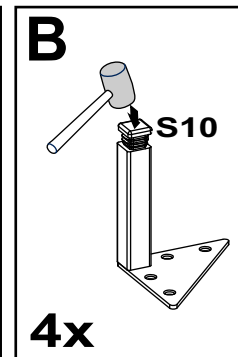
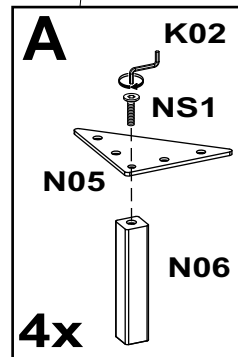
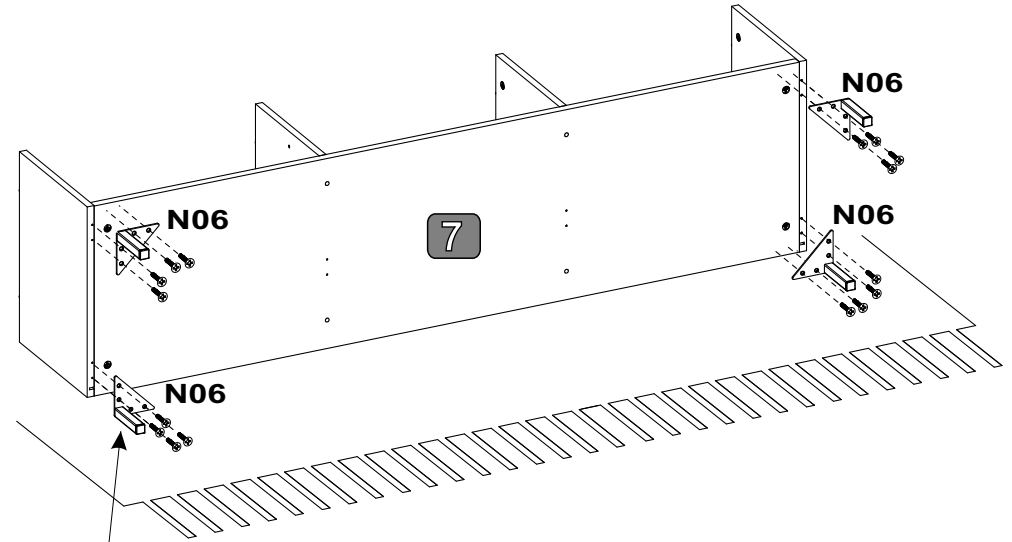

6

2x N07	2x S11	M5-20 2x NS1	2x N05	Z3 1x K02
		2x N08	4x16 8x W25	

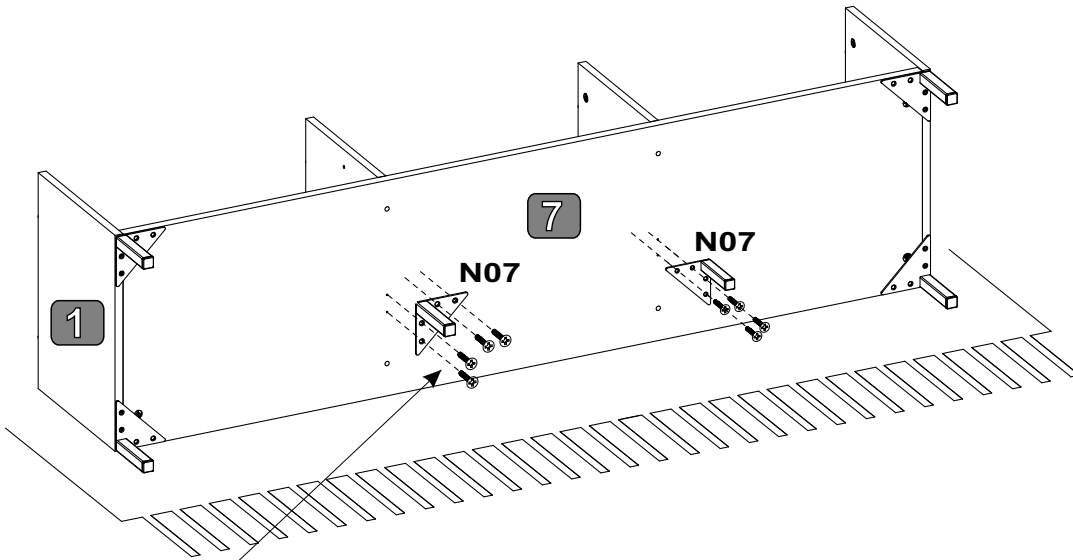

7

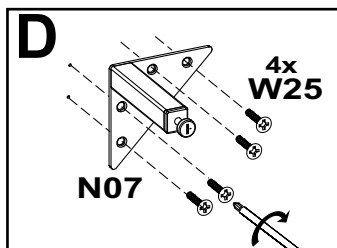
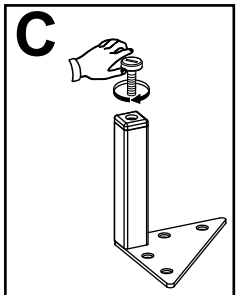
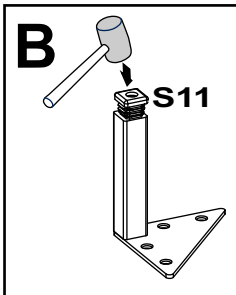
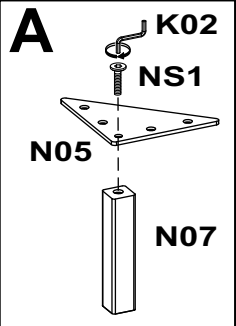
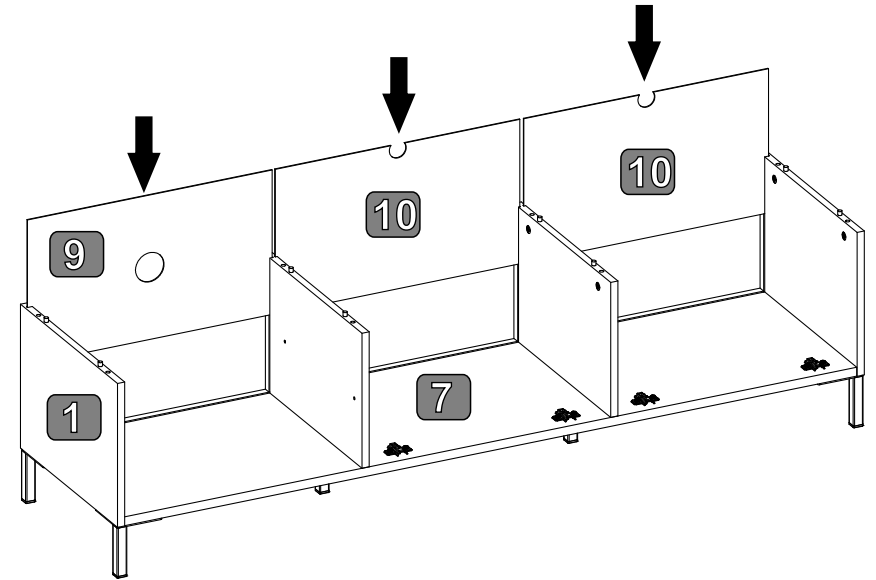

8

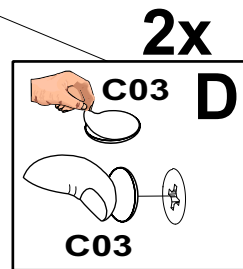
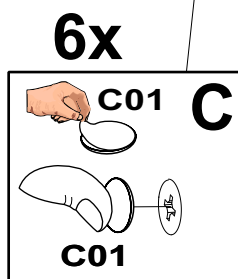
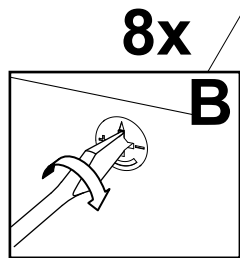
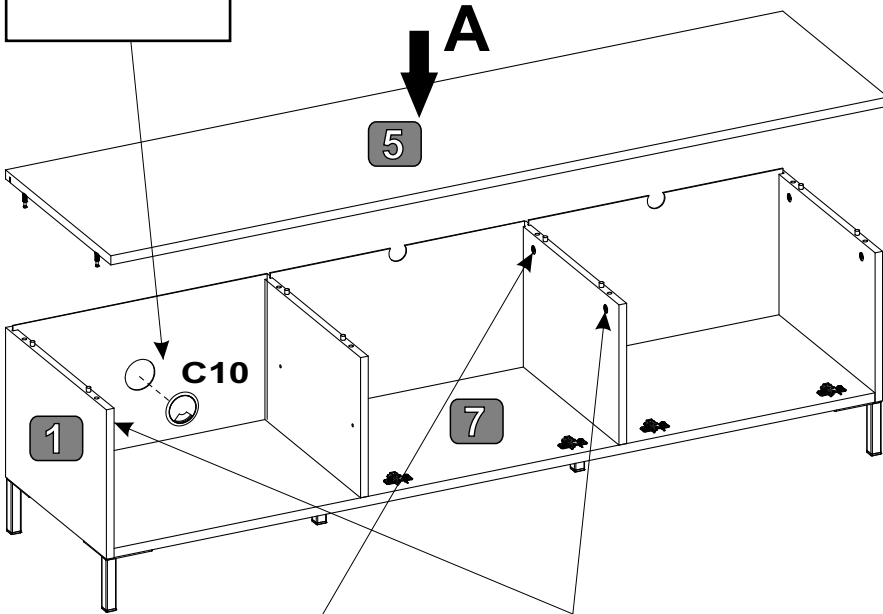
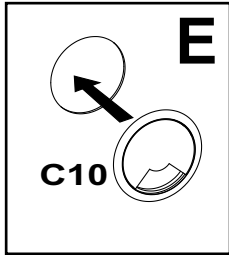
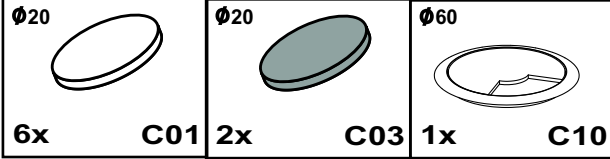



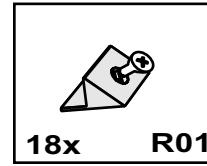

9

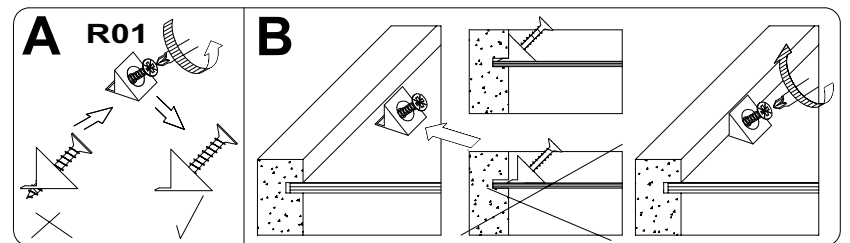
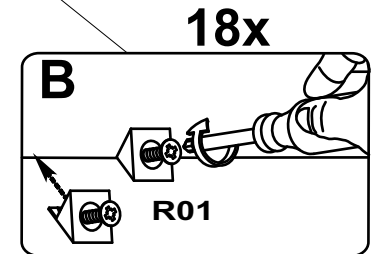
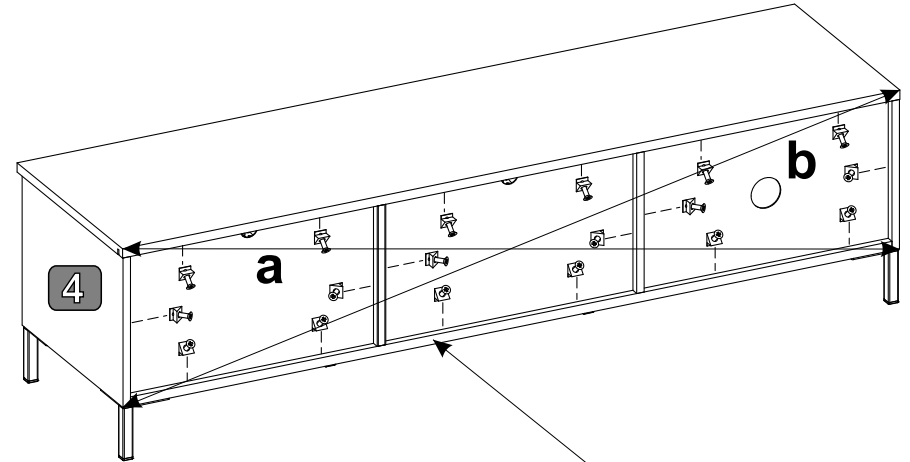
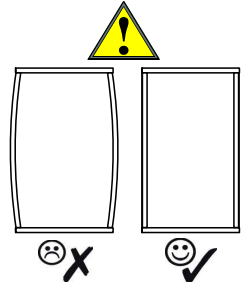

a=b

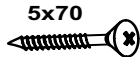

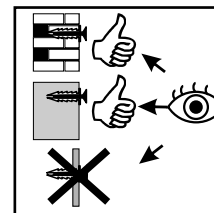
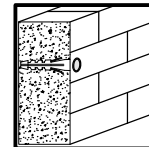
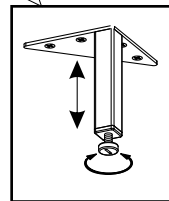
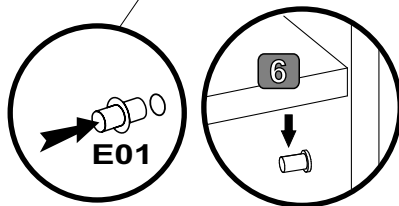
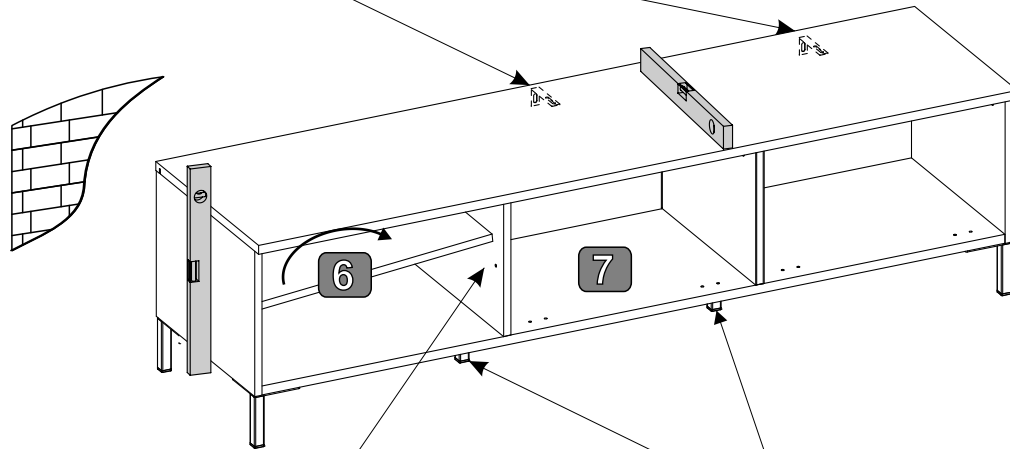
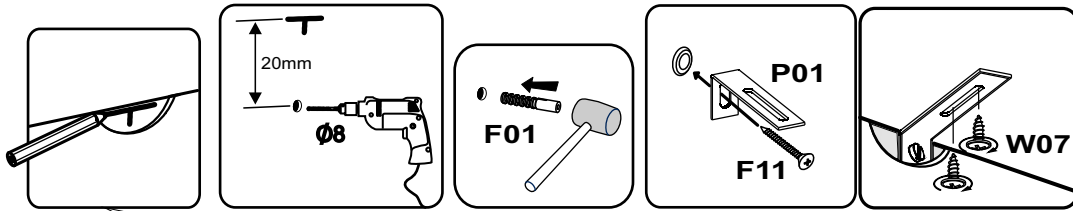
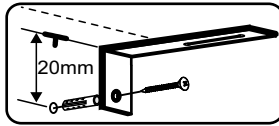

10

 4x E01	 2x F11	 2x F01	 2x P01	 4x W07
---	---	---	---	---



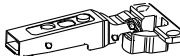
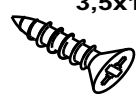

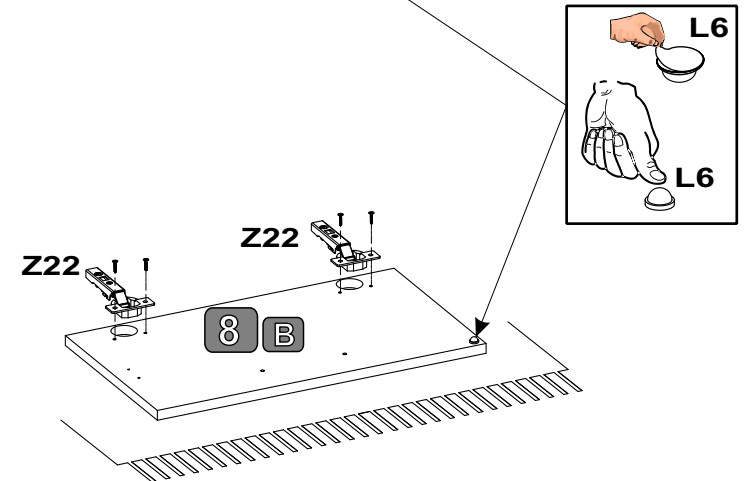
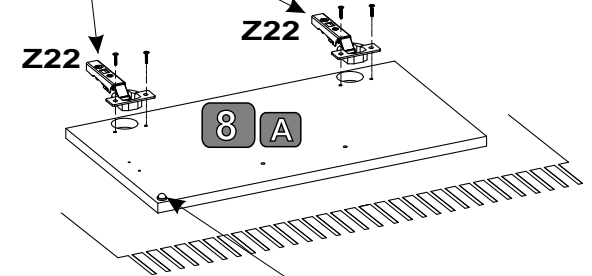
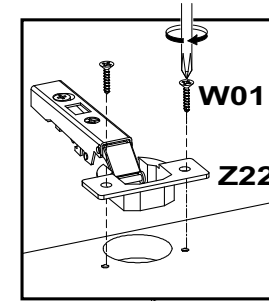

11

 4x Z22	 8x W01	 2x L6
---	---	--



12

			
2x S42	4x W28	2x R10	12x W08

