

Nr	Ausmaß		St	Colli
1	1197	279	15	1
2	1197	279	15	1
3	700	280	16	1
4	700	280	15	1
5	664	123	18	1
6	220	100	12	1
7	220	100	12	1
8	636	100	12	1
9	646	219	2	1
10	664	346	18	3
11	656	88	10	3
12	656	140	10	6
13	1211	682	2	1

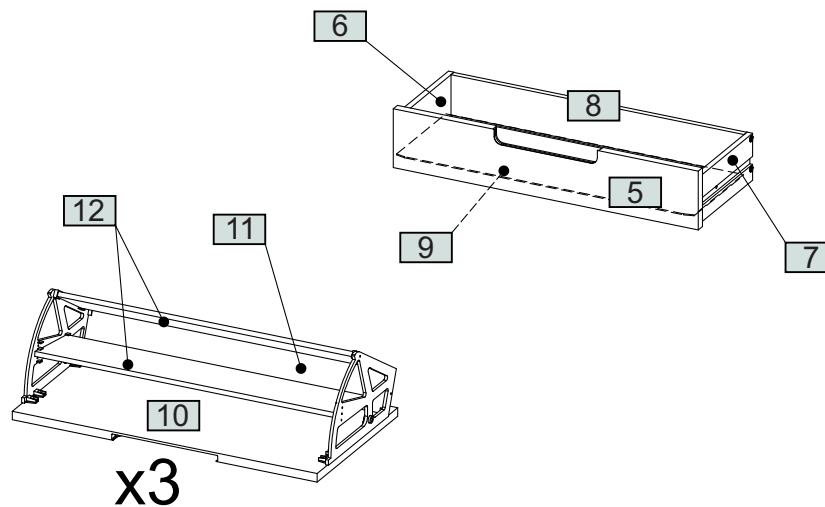

1

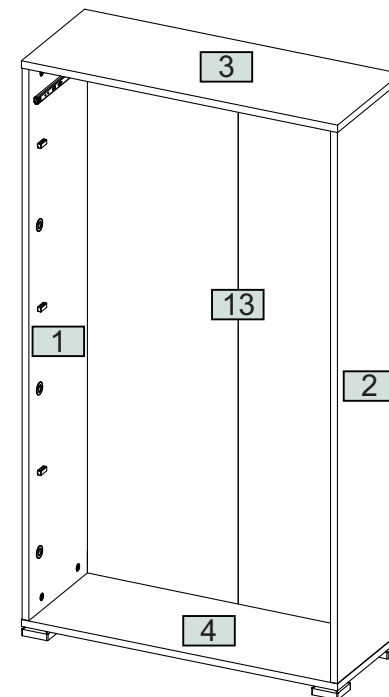
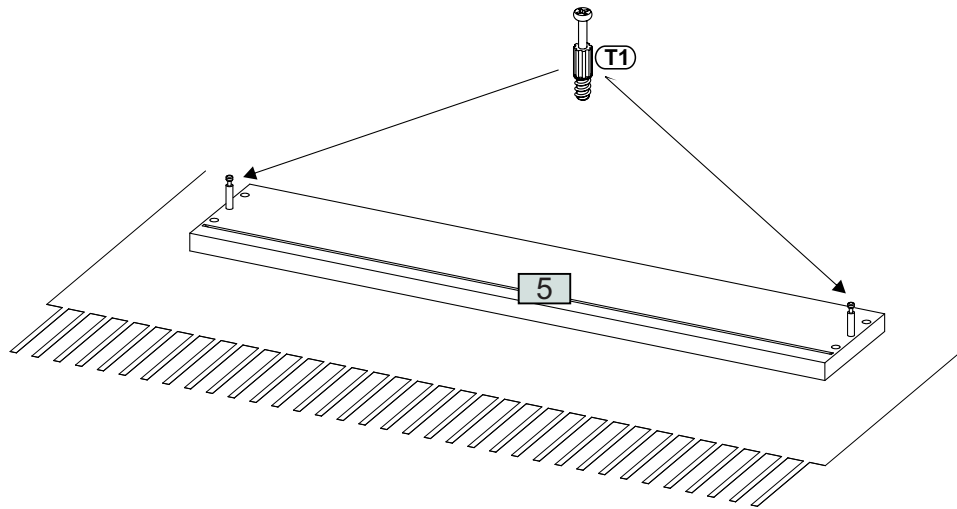
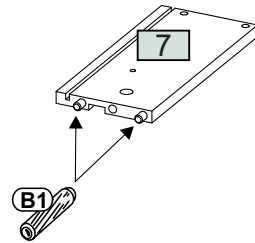
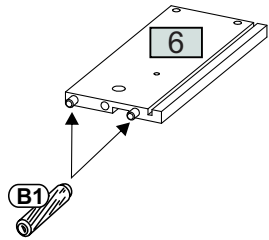
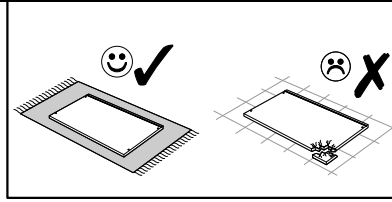
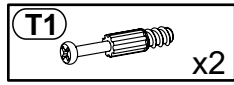
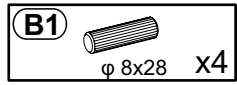

2

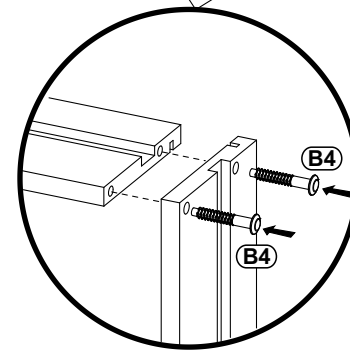
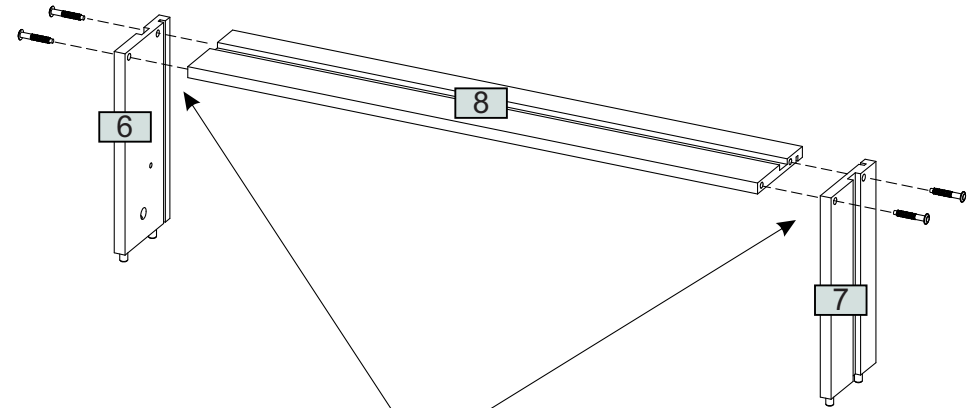
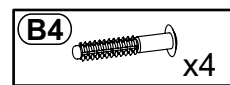

3

M12 x2

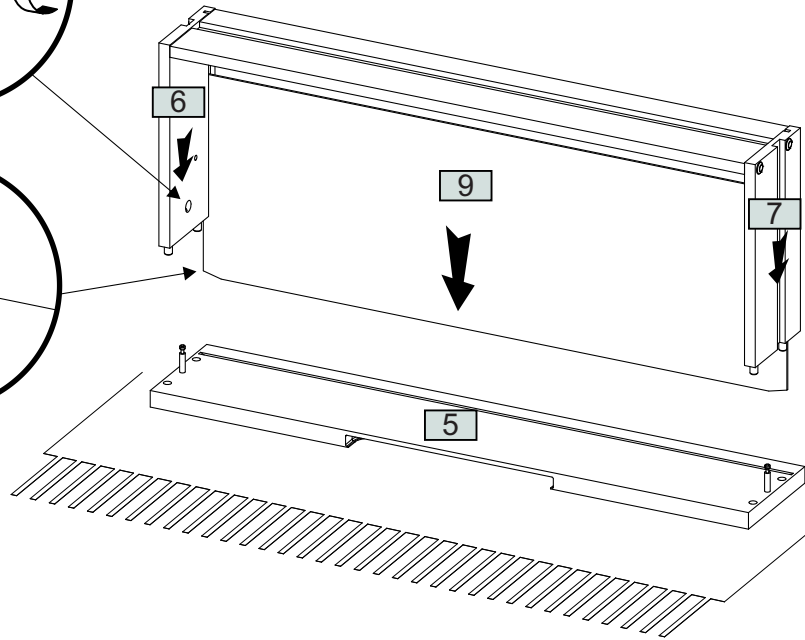
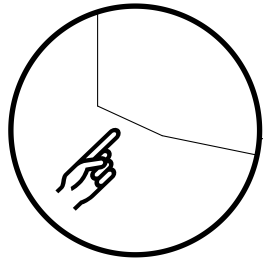
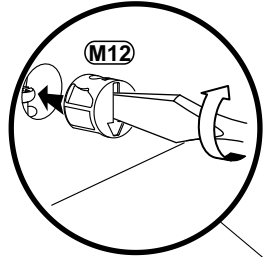
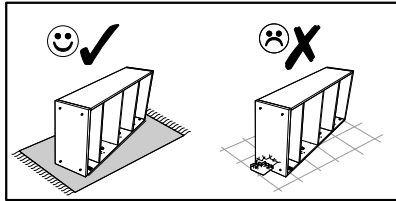

4

J23 x6

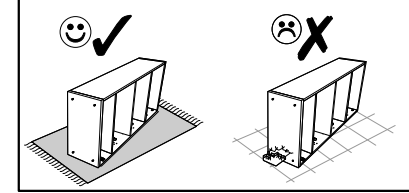

A=B

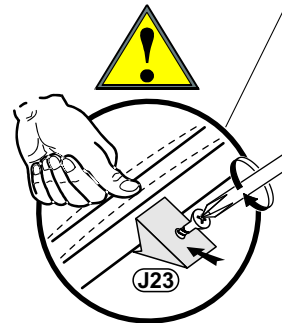
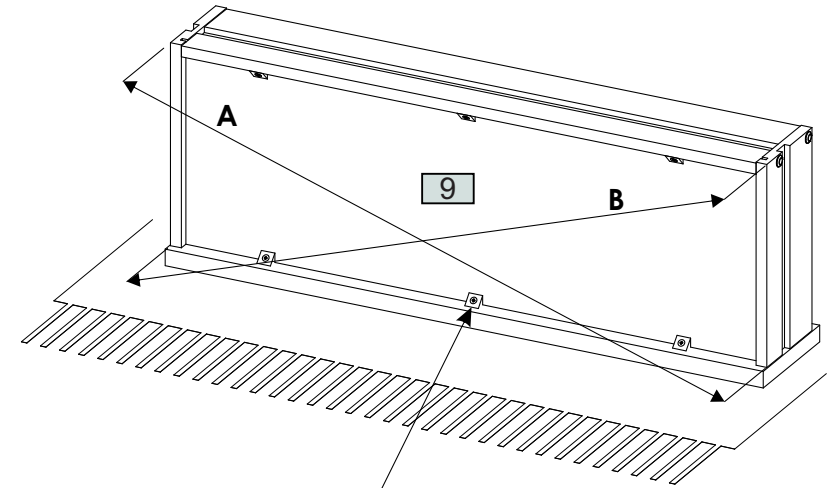



5

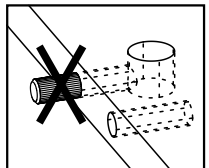
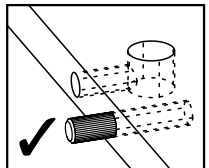
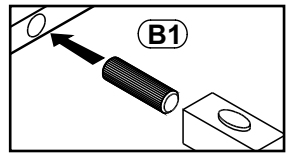
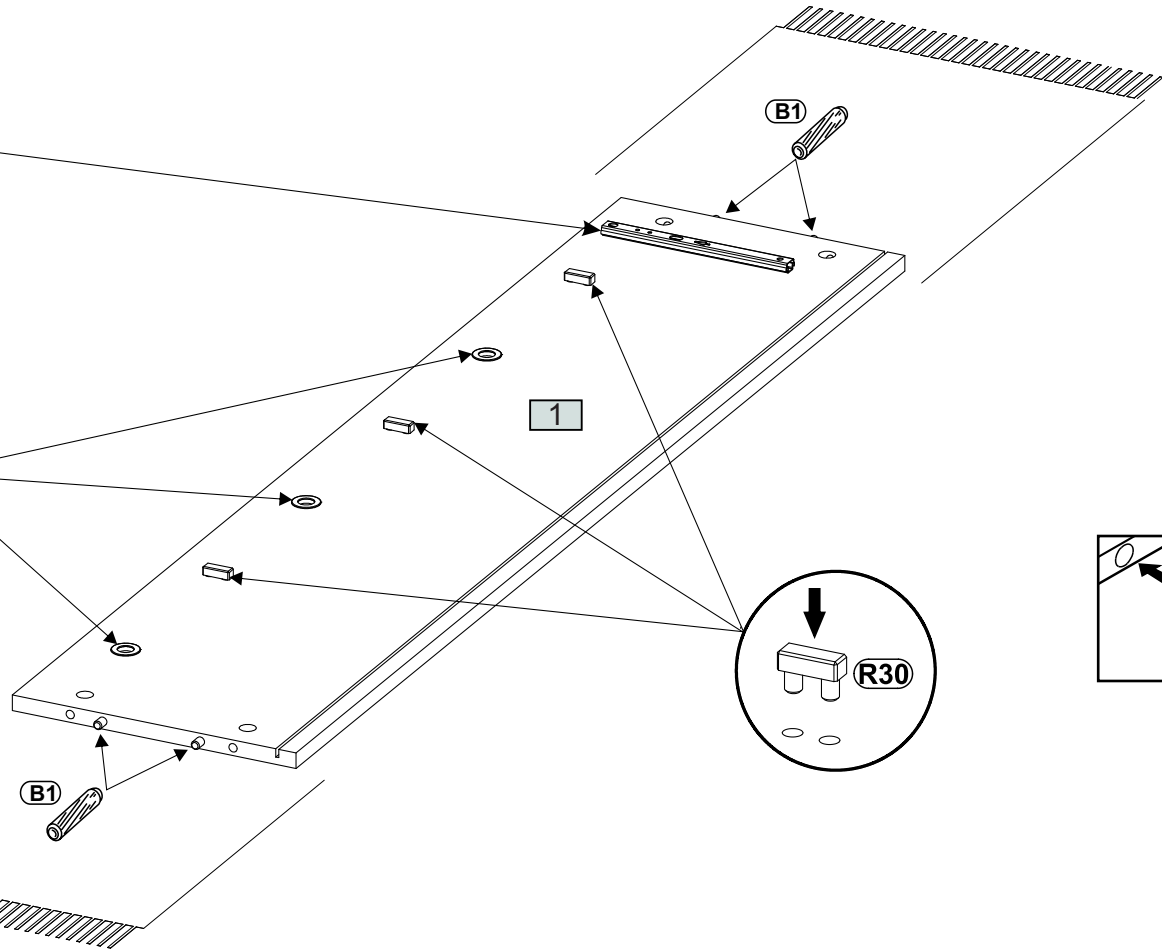
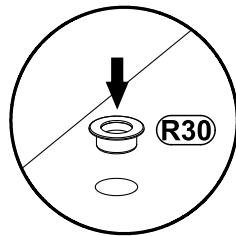
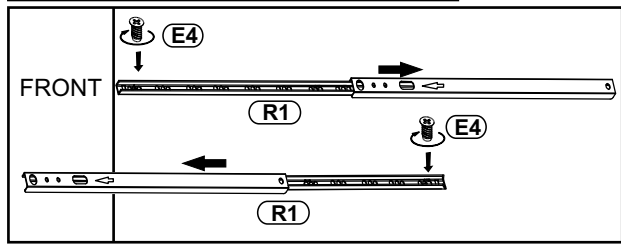
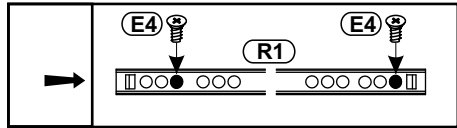
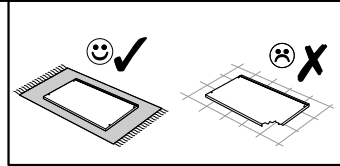
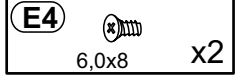
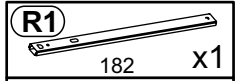
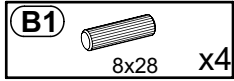
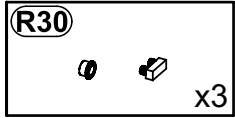

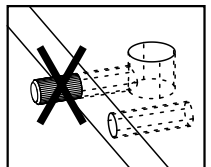
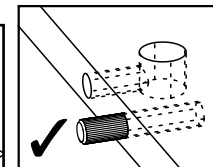
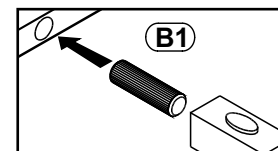
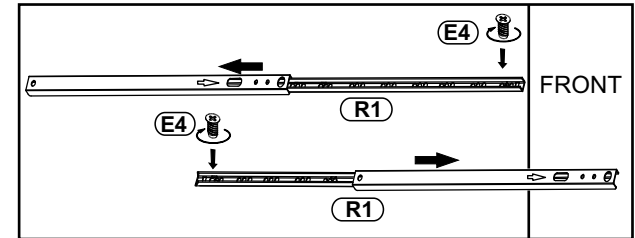
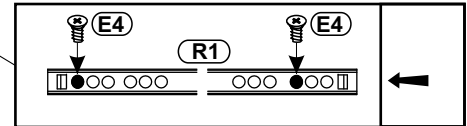
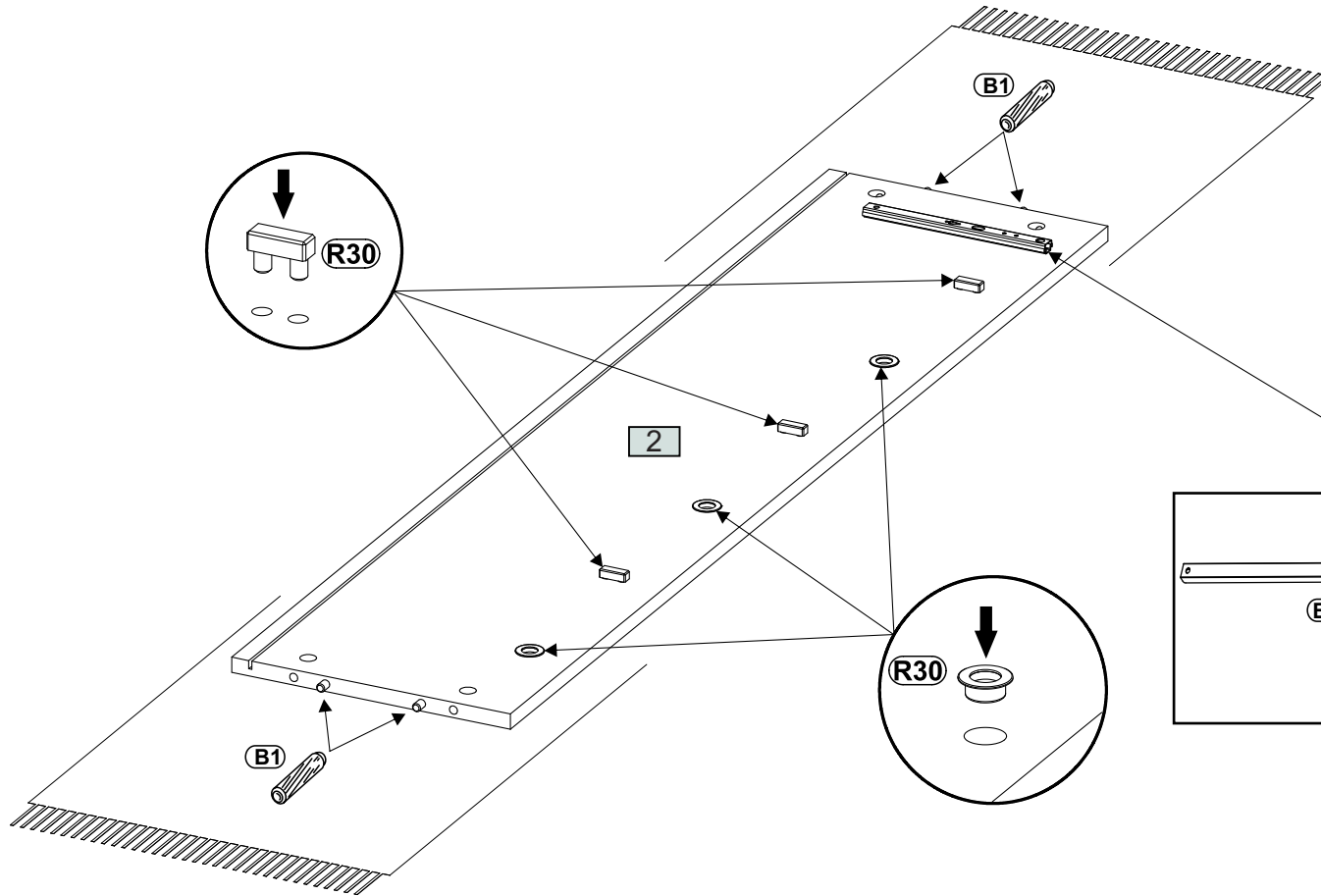
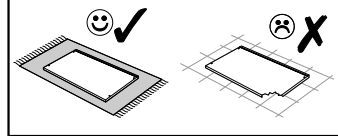
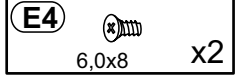
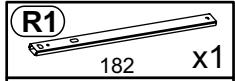
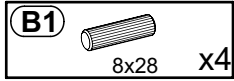
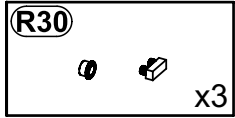

6

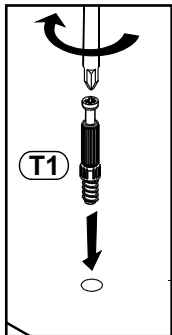
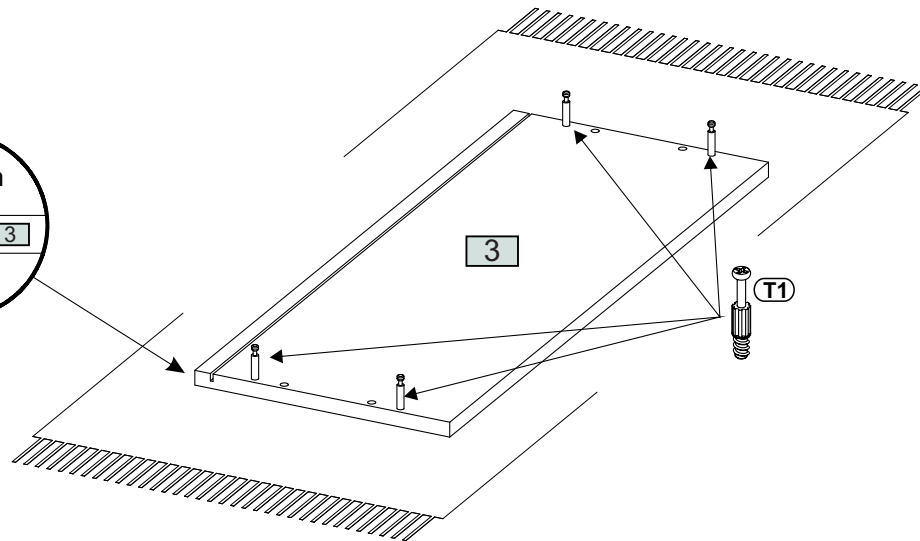
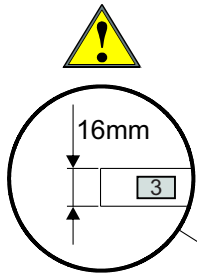
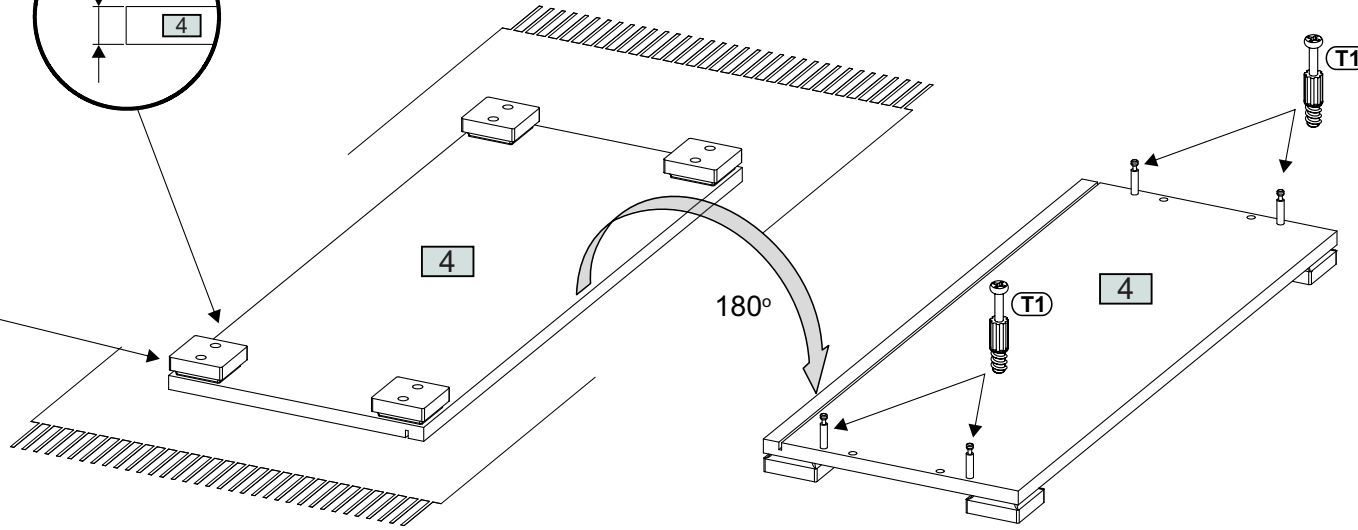
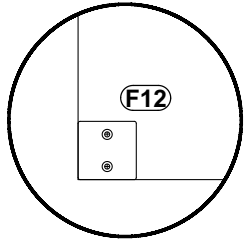
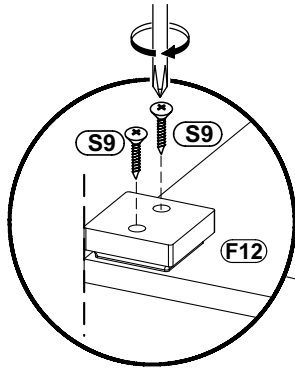
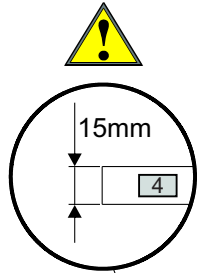
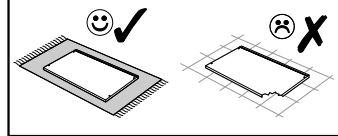
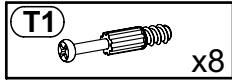
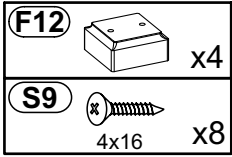

7

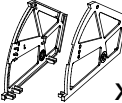

8

- S2**  3x13 x12
- E1**  6,3x13 x18
- R30**  x3

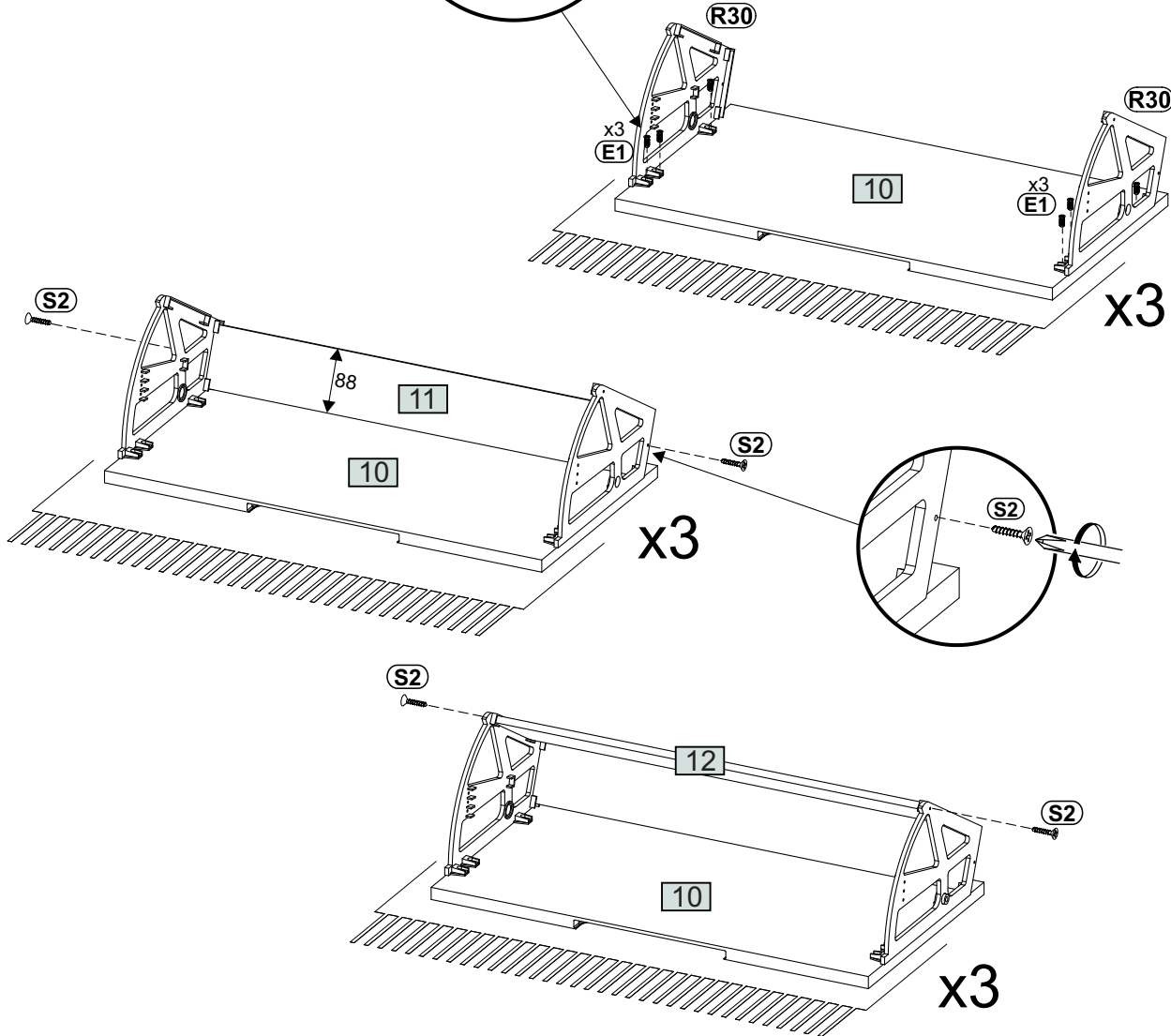
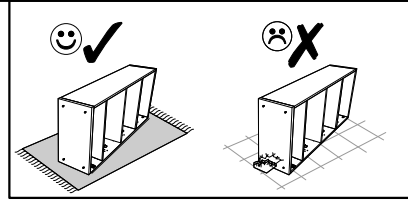
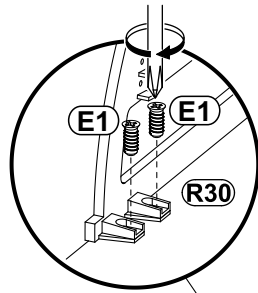

9

- M1**  x4

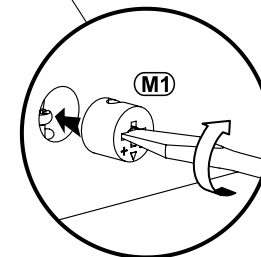
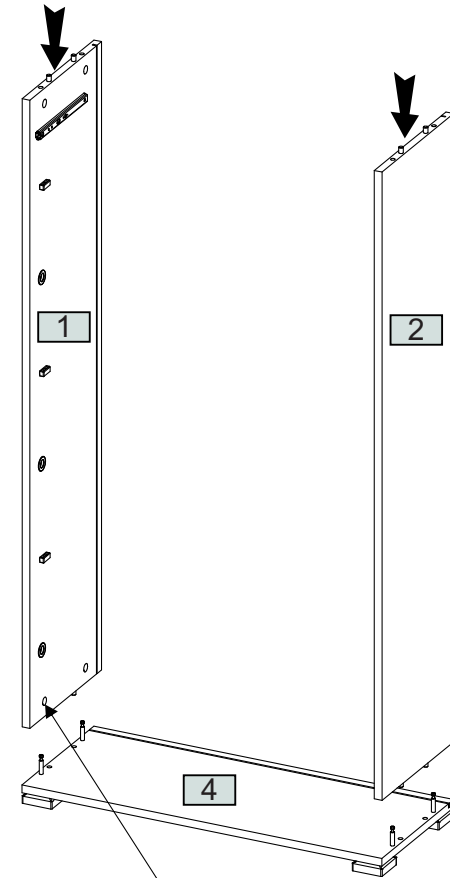

10

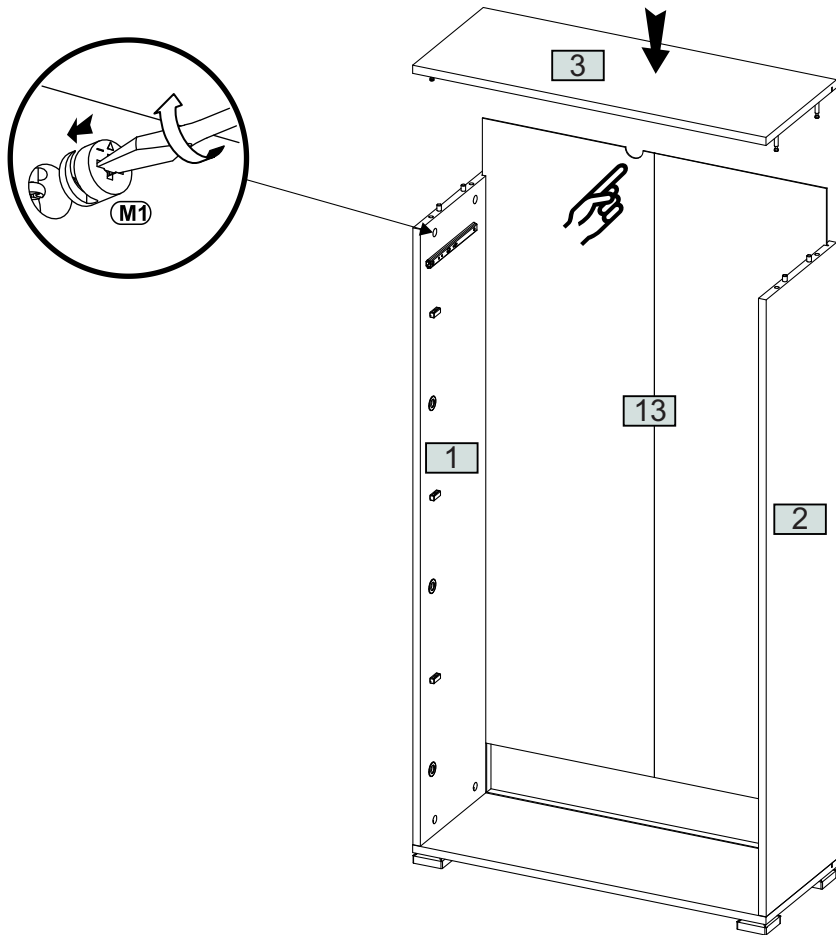

11

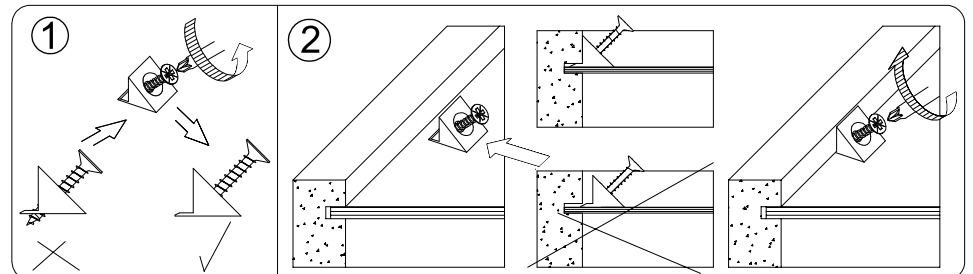
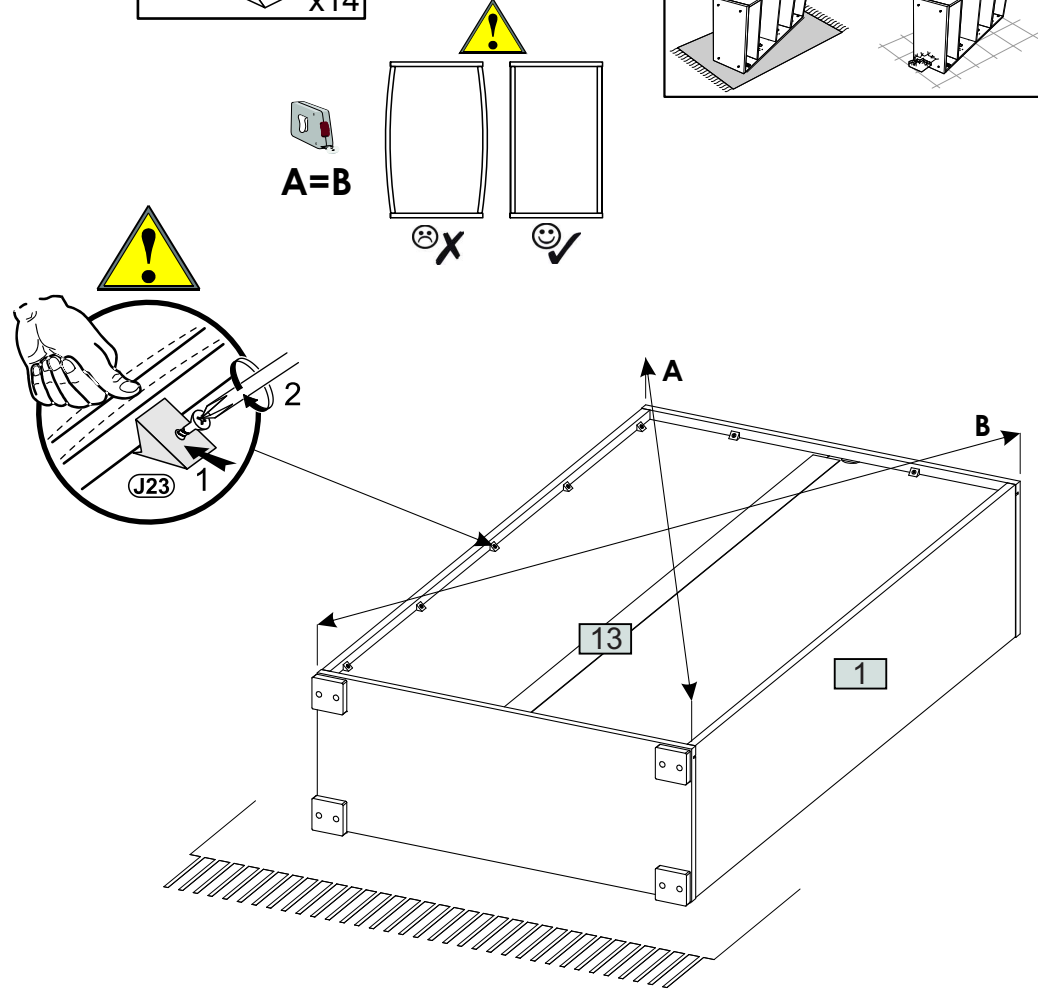
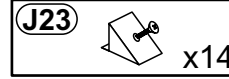

12

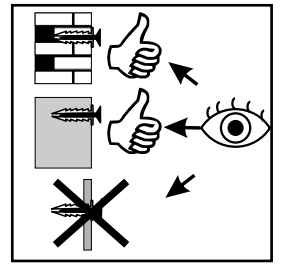
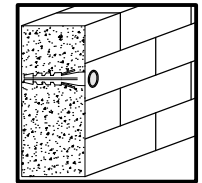
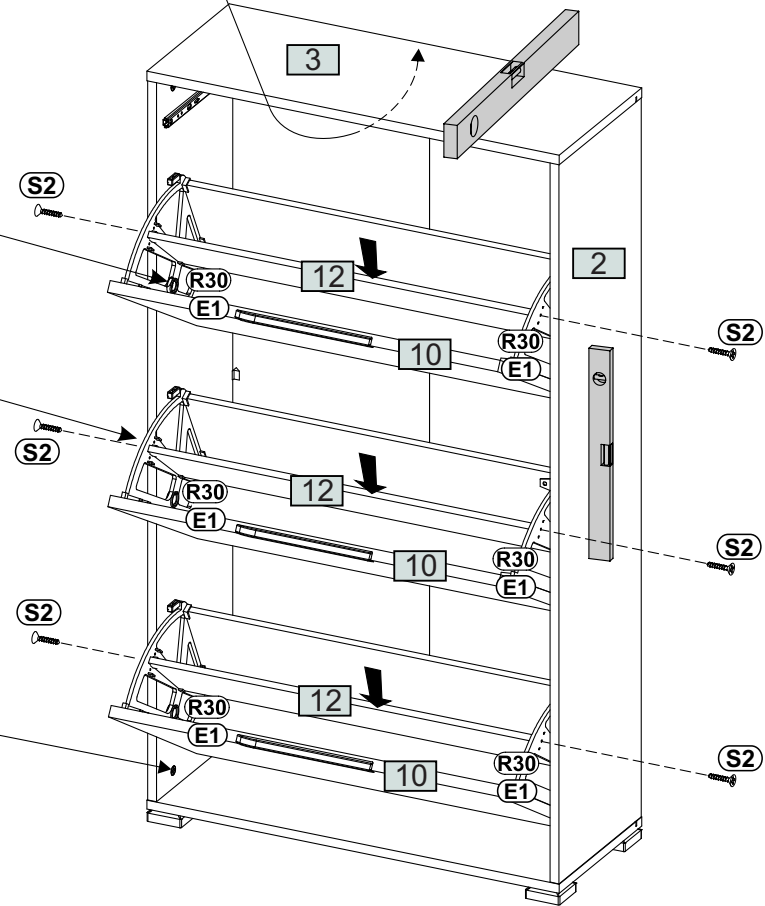
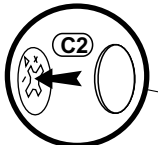
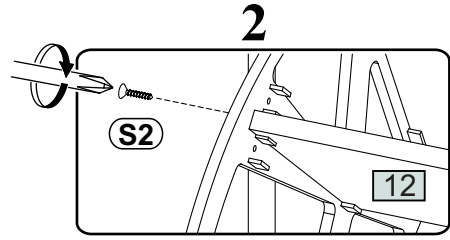
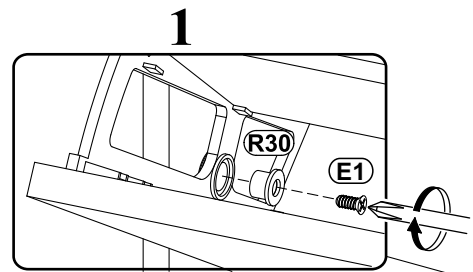
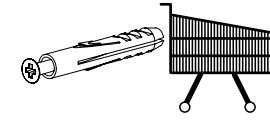
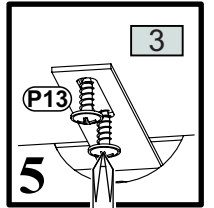
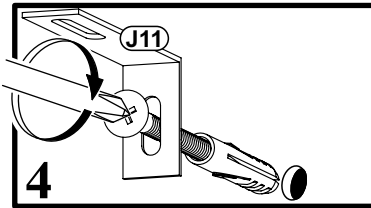
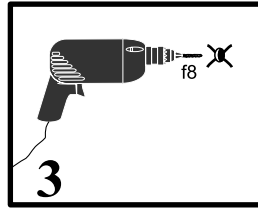
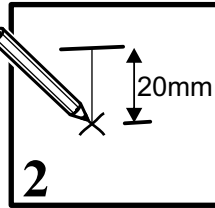
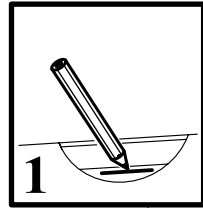
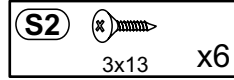
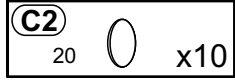
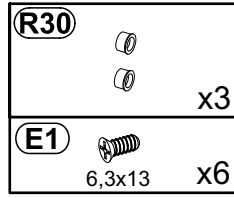
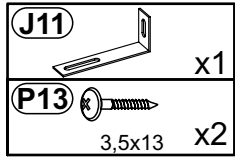

13

A1  
M4x9 x2

