

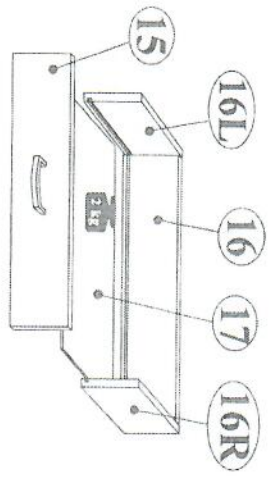

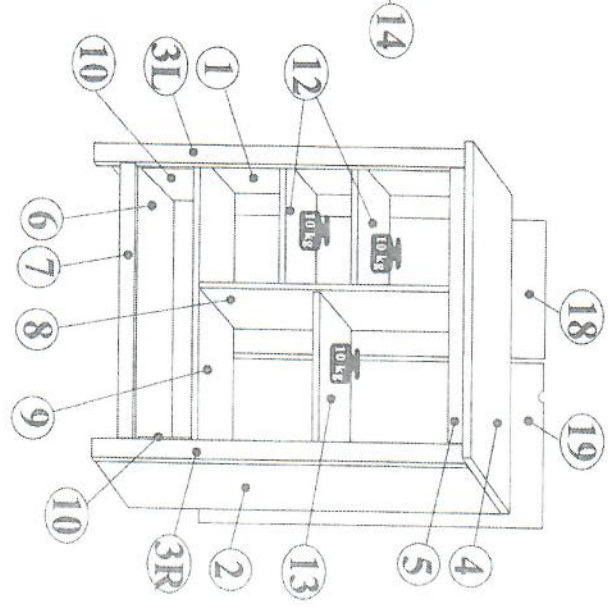

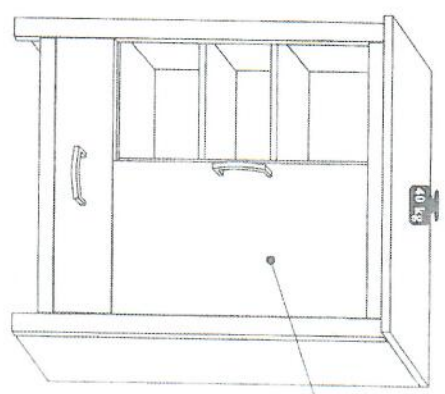

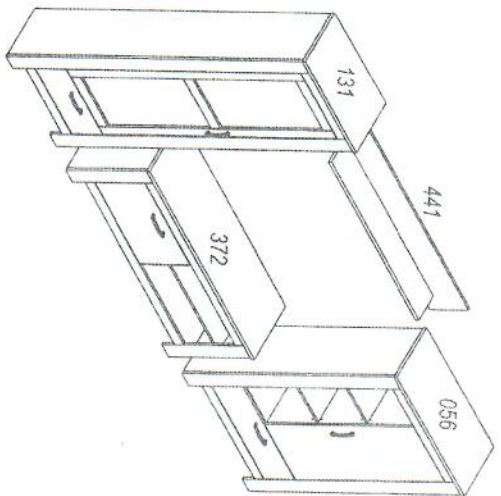









FRIDA P6--FR 056











12	1377	352	2	1/3
3L,3R	1377	90	2	1/3
4	888	376	1	1/3
5	700	60	1	1/3
6	848	332	1	1/3
7	700	60	1	1/3
8	1024	331	1	1/3
9	848	332	1	1/3
10	198	332	2	1/3
12	362	320	2	1/3
13	471	320	1	1/3
14	967	408	1	1/3
15	695	200	1	1/3
16L,16R	302	100	2	1/3
16	631	100	1	1/3
17	642	300	1	1/3
18	1257	374	1	1/3
19	1257	483	1	1/3



NR 1	
B1  φ 8x28 X24	
M1  φ15x12mm X16	
T1  5x39mm X16	
J23  X13+2	
W1  X12	
C14  φ20mm X12	
F1  X5	
S6  3x20 X10	

NR 2	
F33  X14	
P13  3.5x13 X56	
F15  X4	

NR 3	
YR  φ 35 X2	
D7  H4 X2	
E3  6.3x13 X4	
S8  4x13 X4	

NR 4	
R21  L-300 mm X1L/1R	
E24  6x11 X6	
P10  3x13 X4	
S3  3.5x13 X2	
M2  φ12x10mm X2	
T2  5x35mm X2	
P5  4x30 X4	

NR 5	
U168  X2	
P14  3.5x30 X4	

NR 6	
J11  X1	
P13  3.5x13 X2	



FRIDA P6-FR 056

4 / 11

1

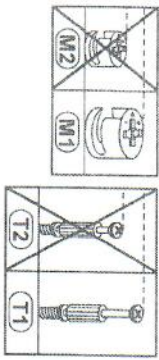
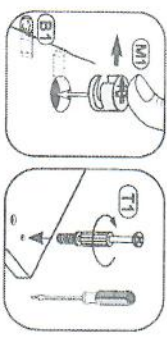

- (B1)** $\phi 8 \times 28$ X16
- (M1)** $\phi 15 \times 12 \text{mm}$ X16
- (T1)** 5x39mm X16
- (W1)** X12

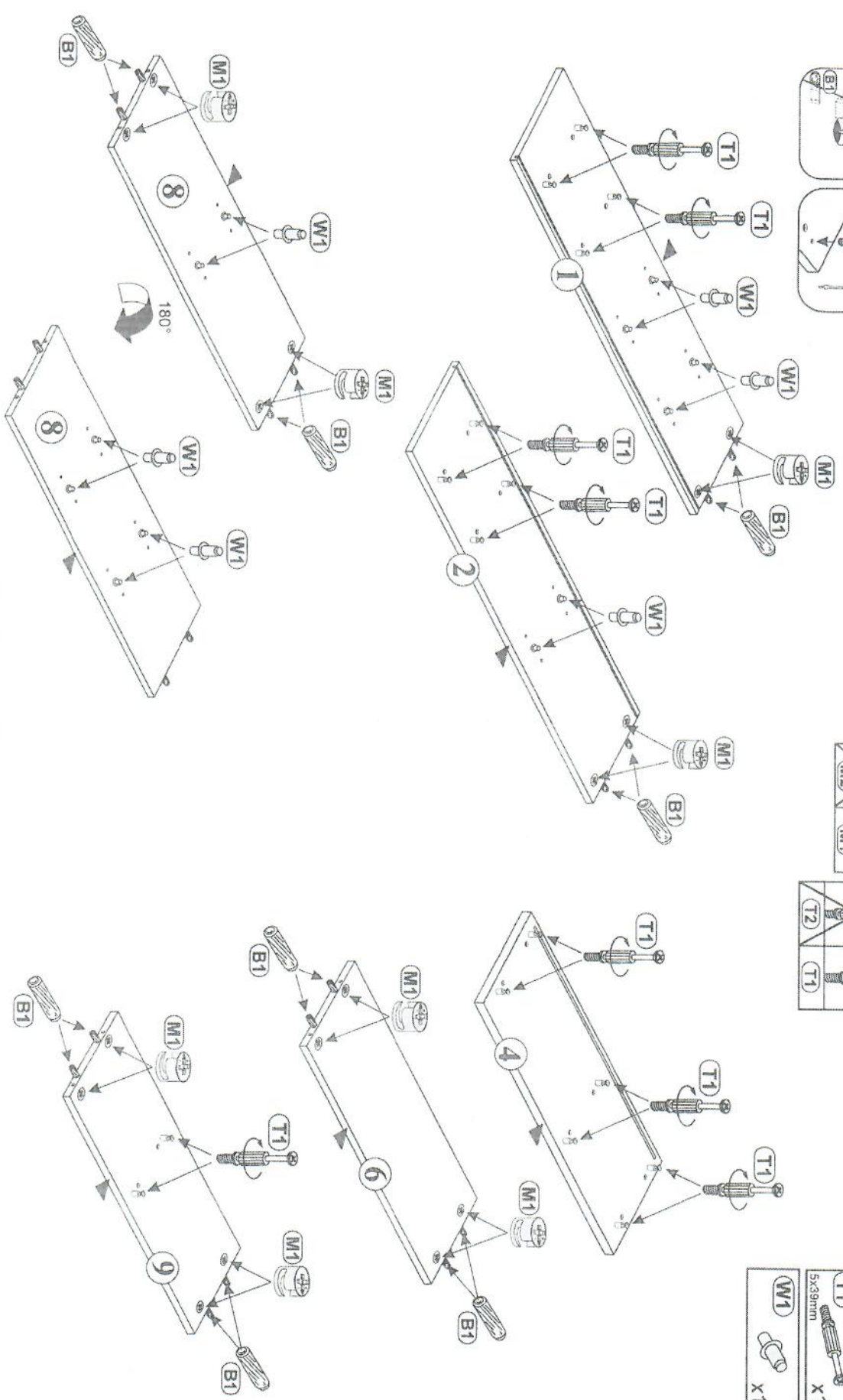

2

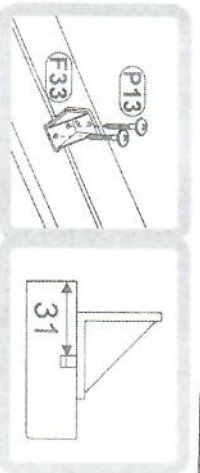
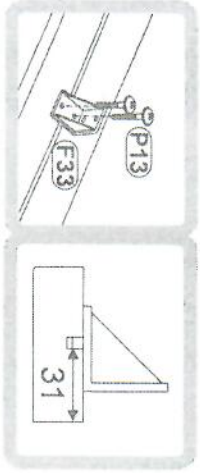
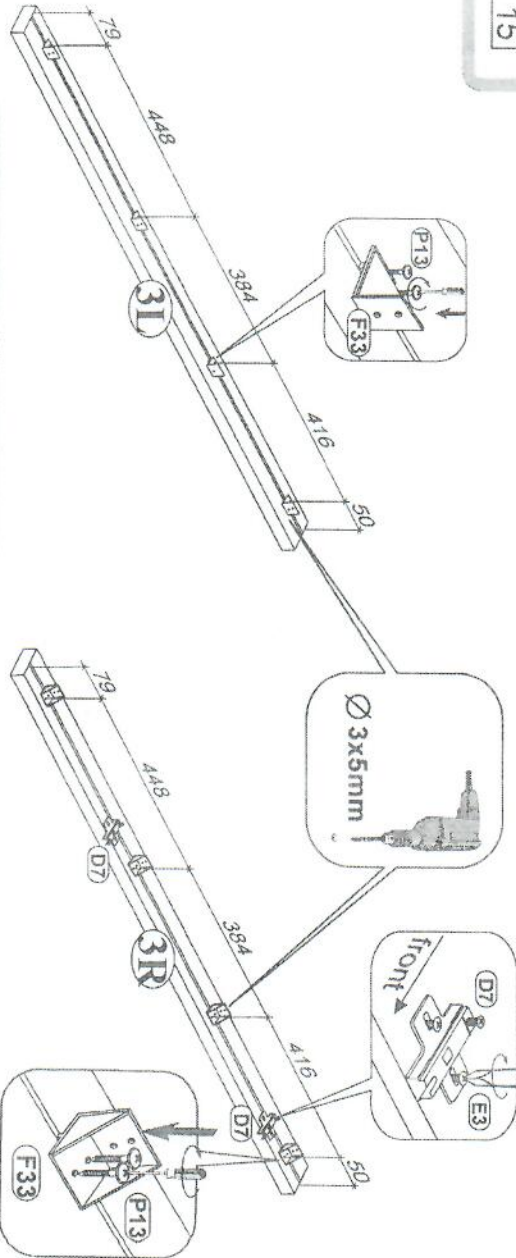
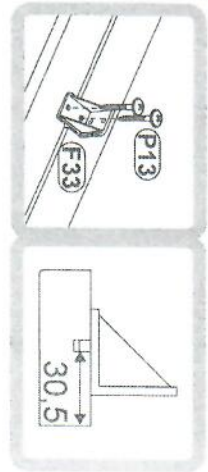
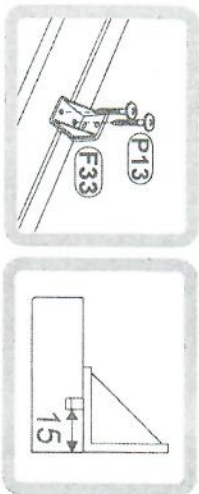
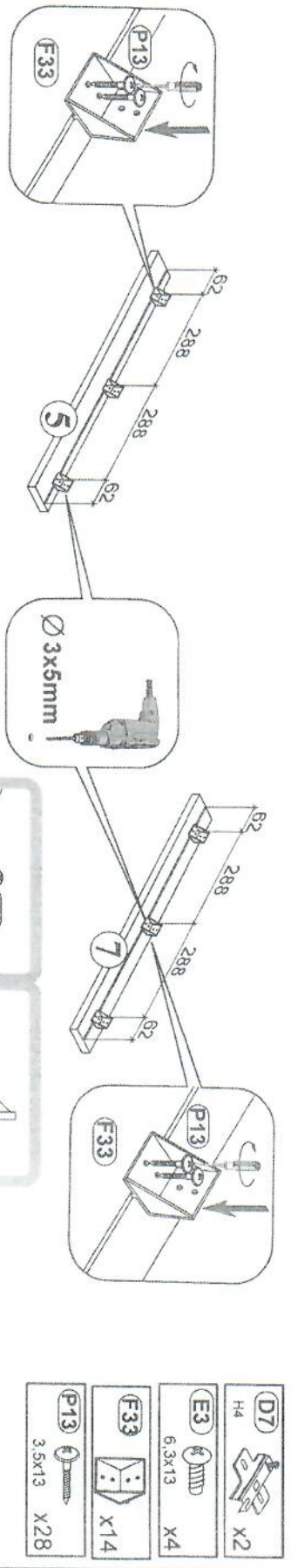

3

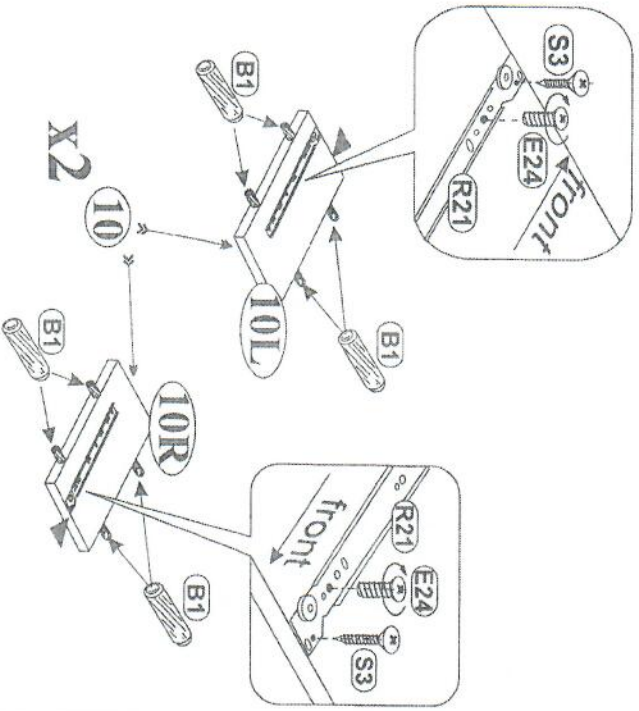
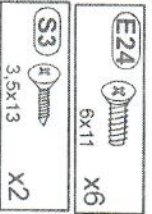
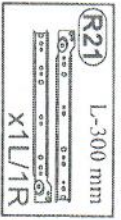

4

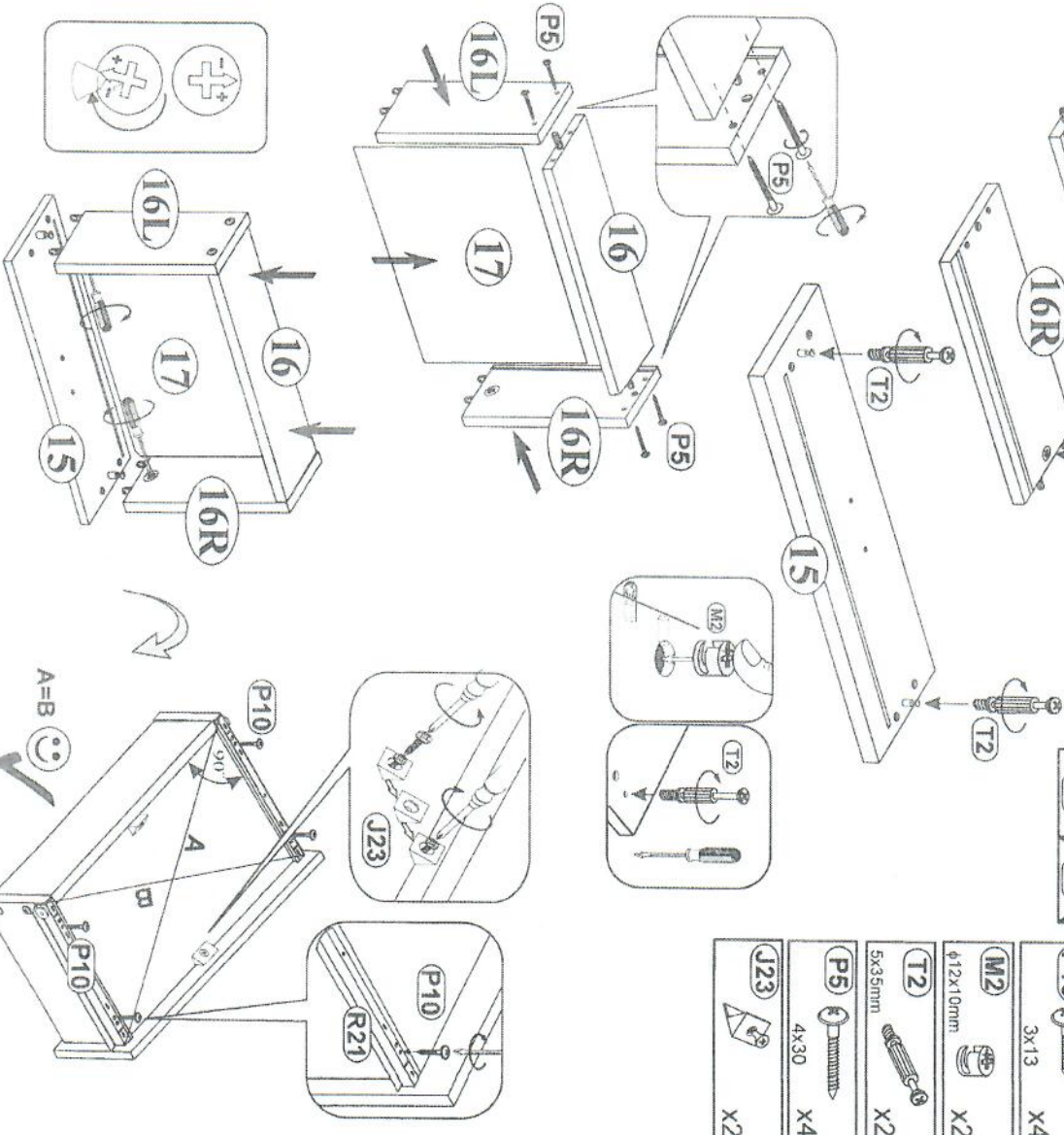
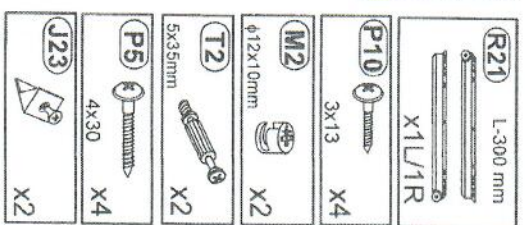
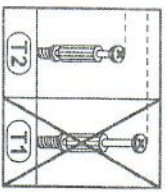
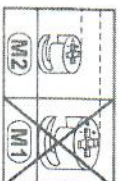

FRIDA P6-FR 056

5

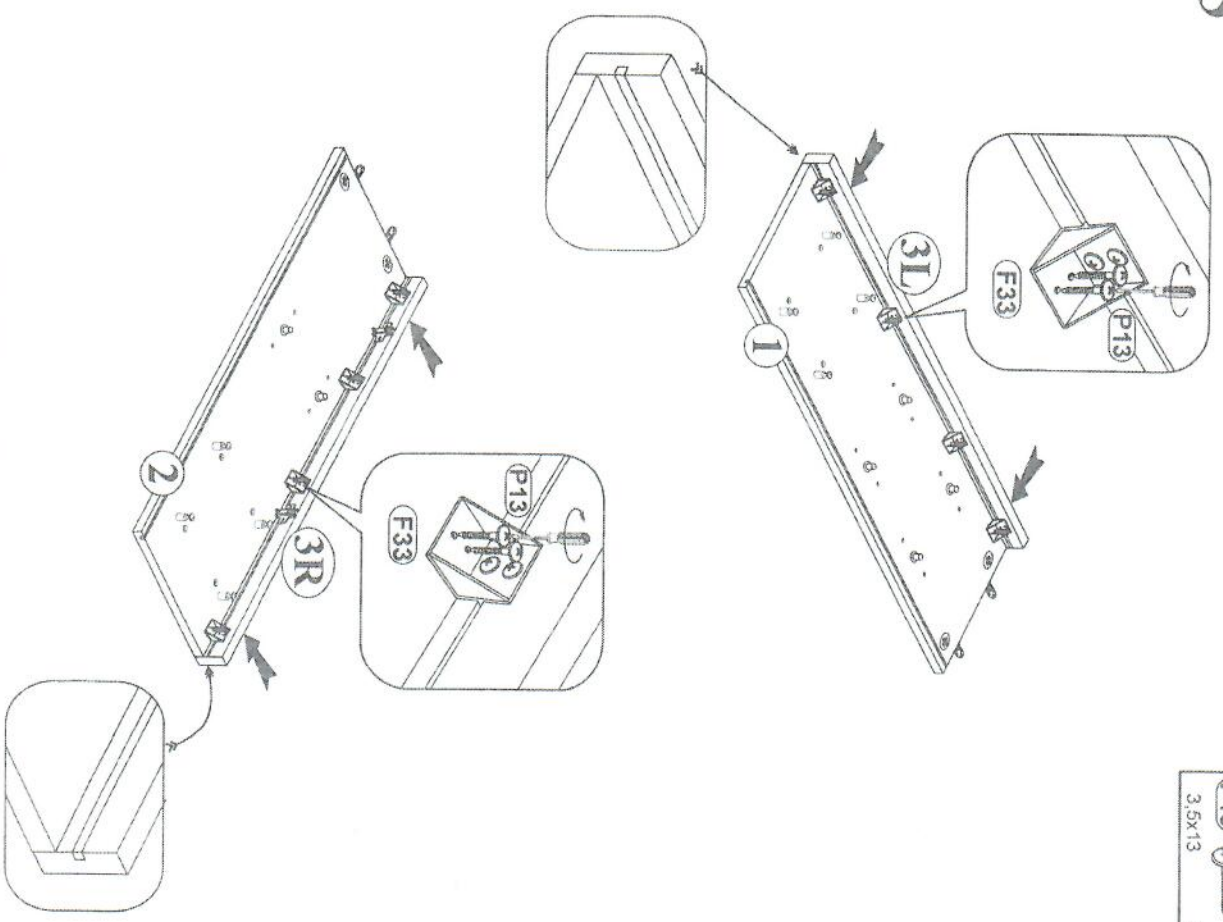

6

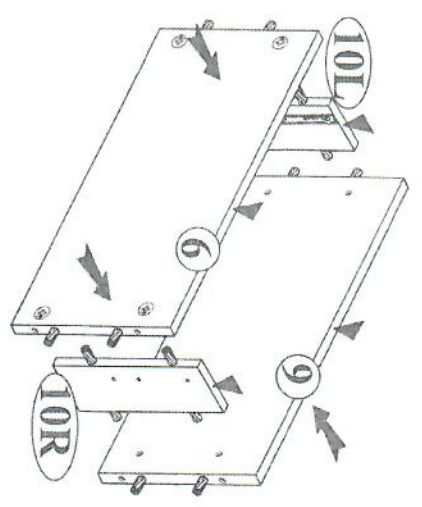

7

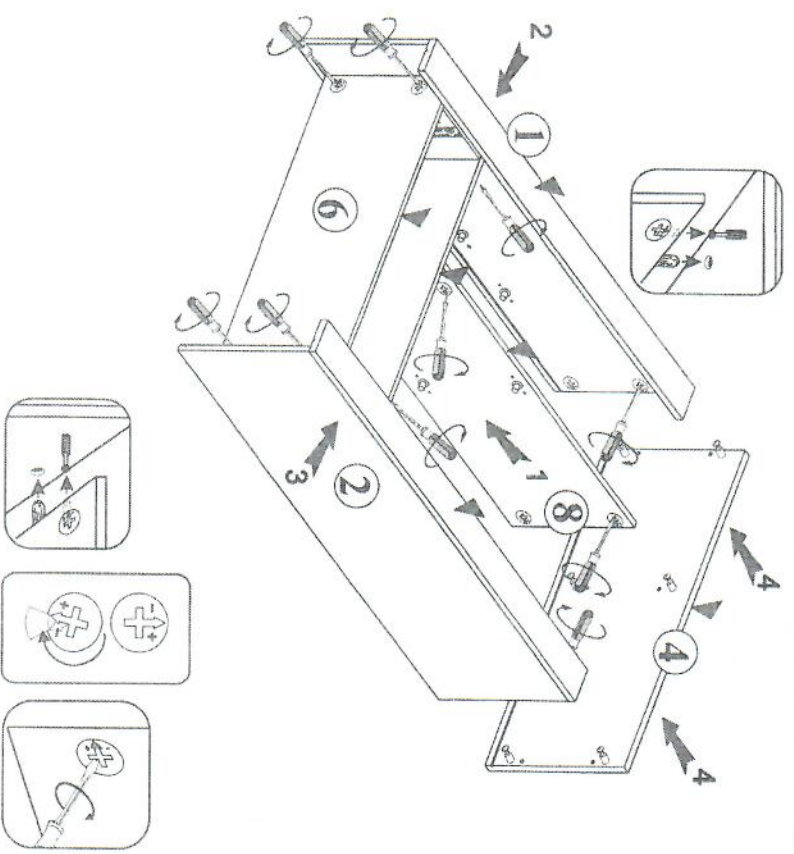

8

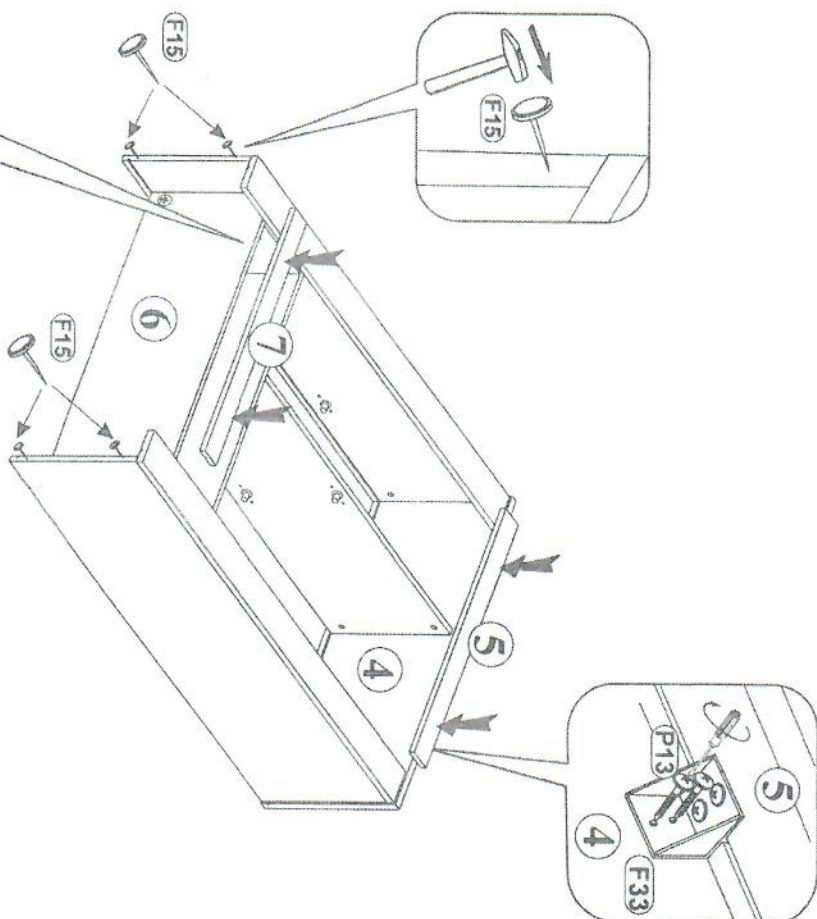

9

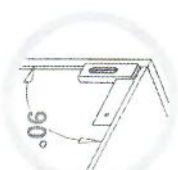
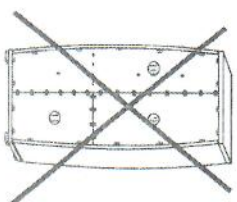
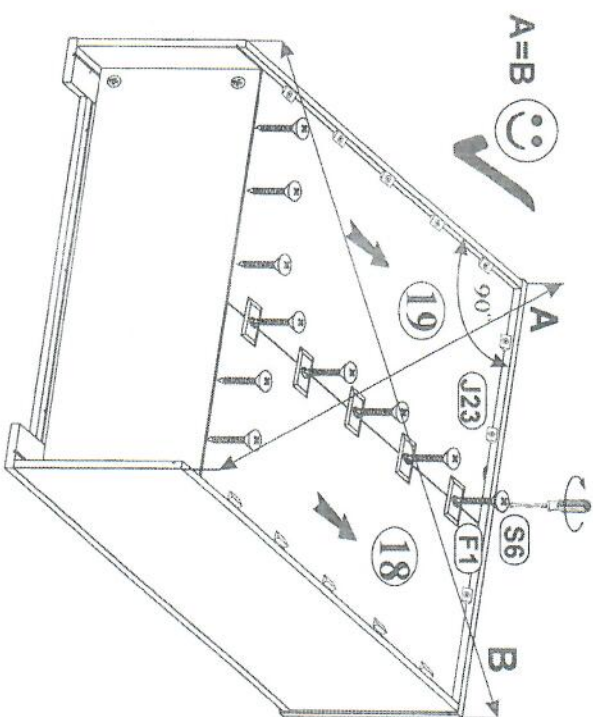
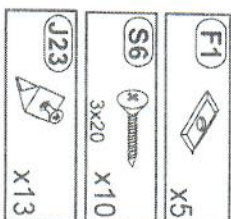

1

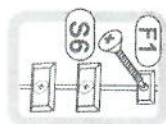





2



3

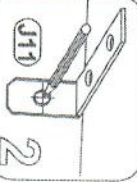

10

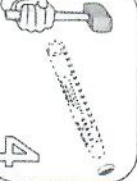
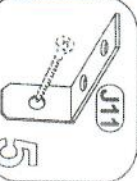
-  P13 3.5x13 X2
-  J10 X1

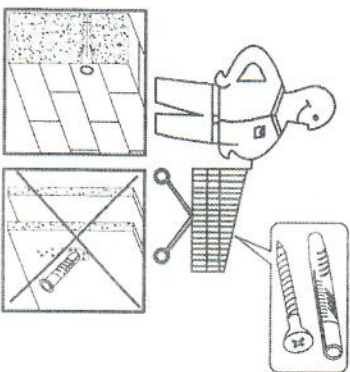
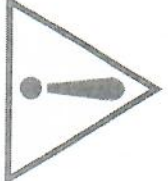
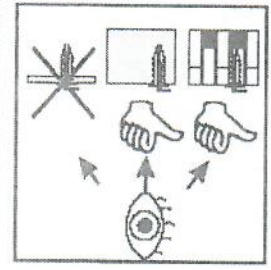
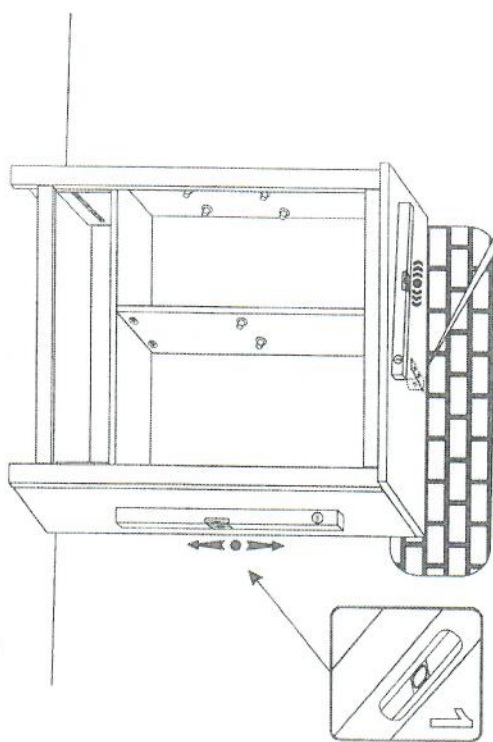
-  J11 2
-  3 $\phi 8$
-  4
-  J11 5
-  J10 4
P13 19
J11 6



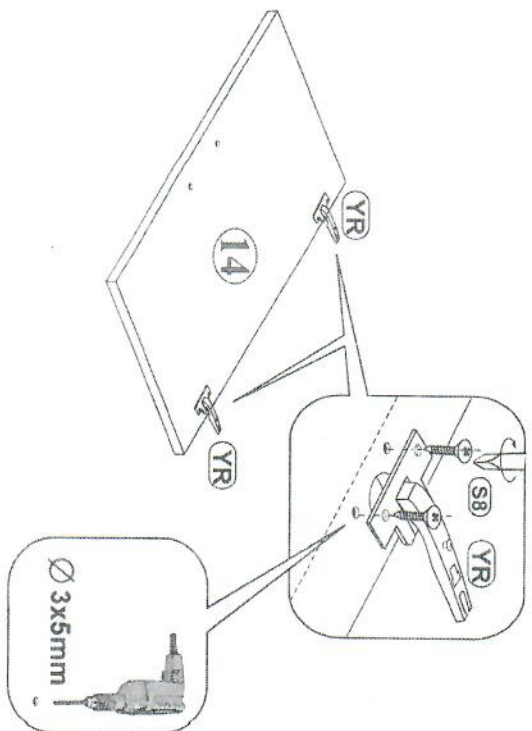
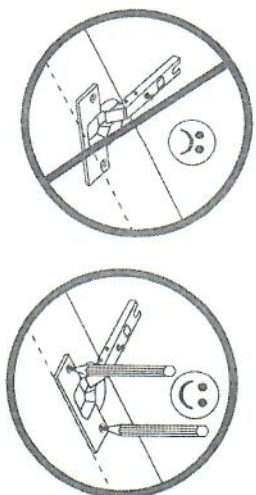

11

-  YR X2
-  S8 4x13 X4



12

C14 6x3mm 	U168 
X12	X2
P14 3.5x30 	X4

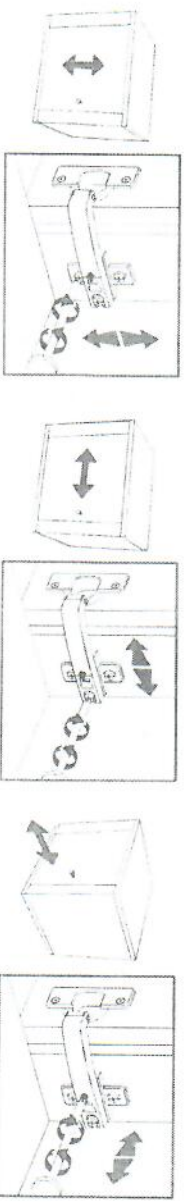
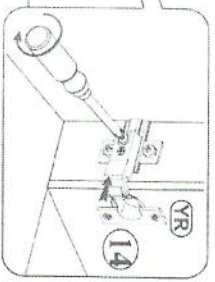
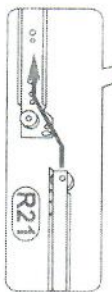
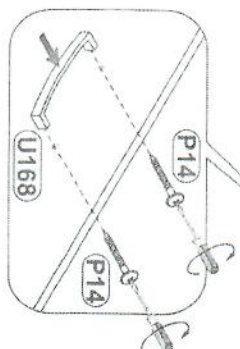
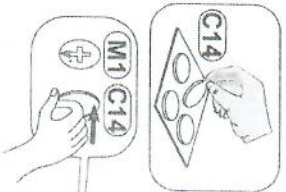
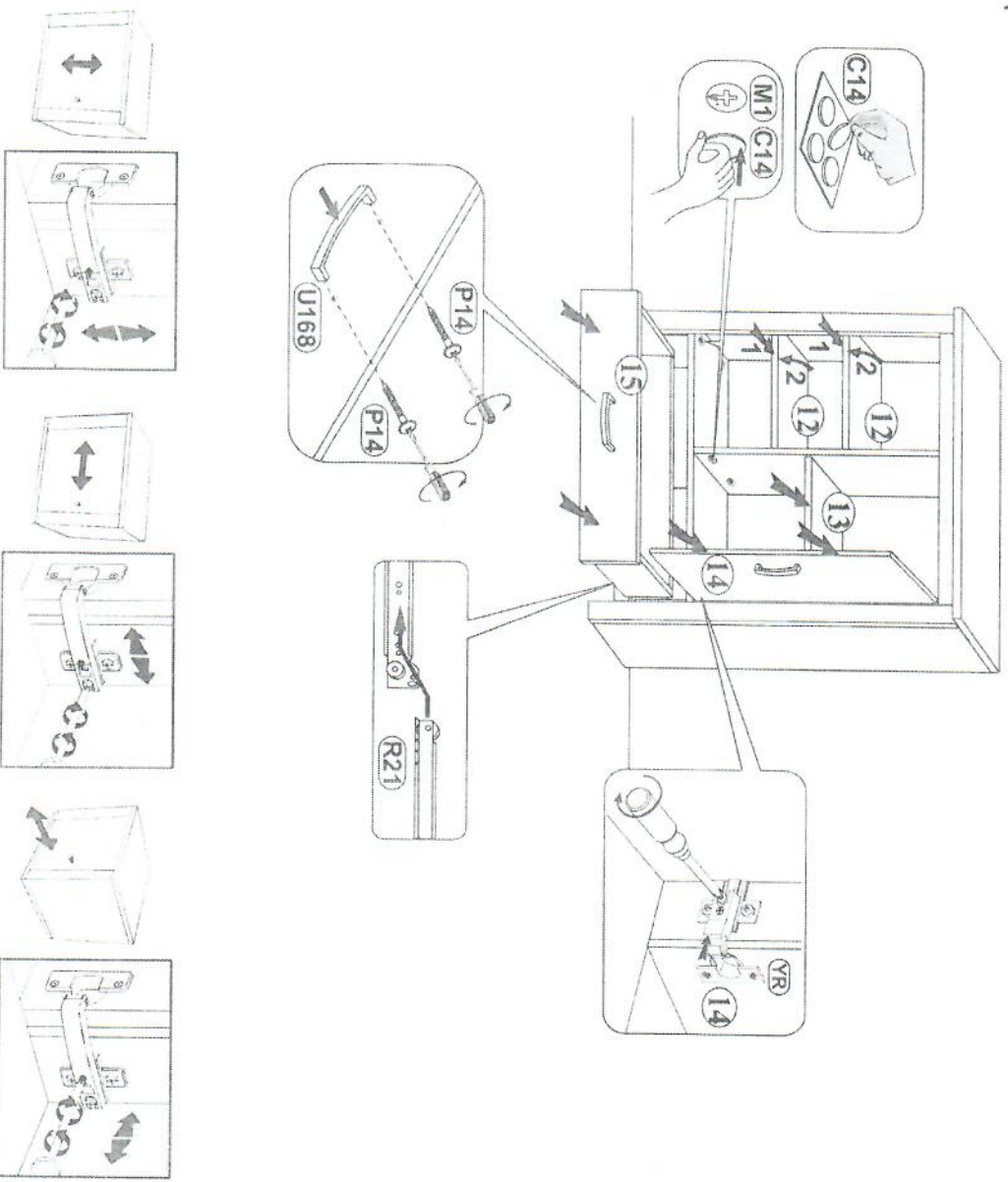

FRIDA P6--FR 056

