

FRIDA P6--FR

372+441

1 / 13

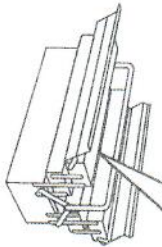
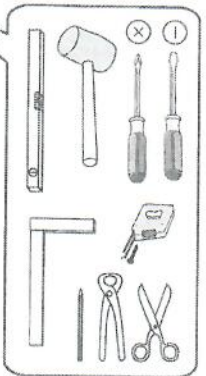
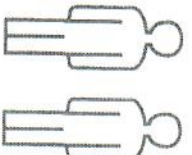

441

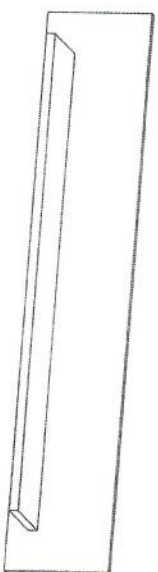

372

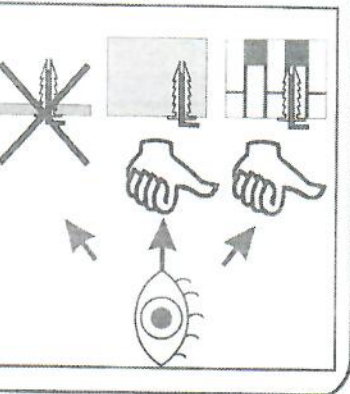
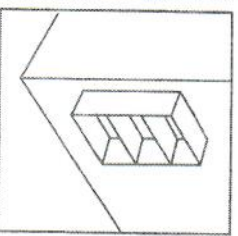
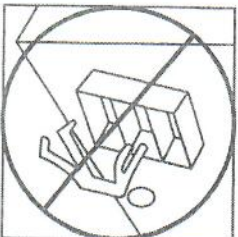
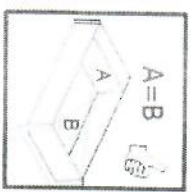
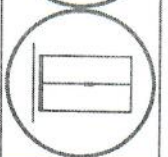
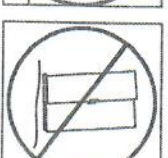
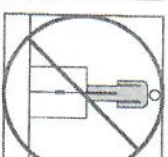
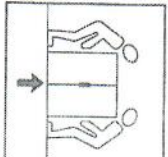
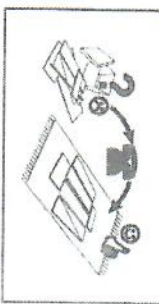
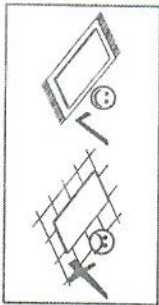
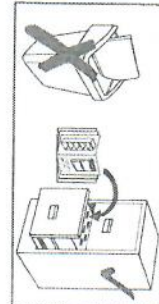
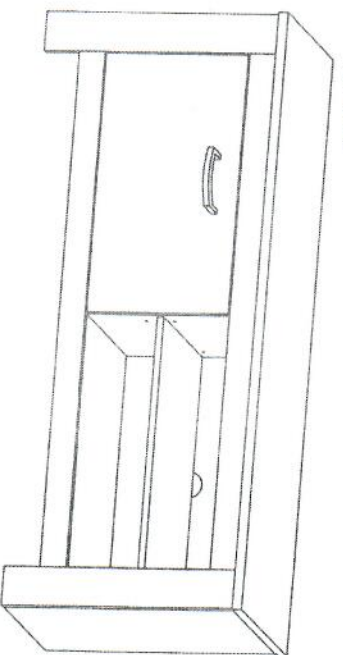





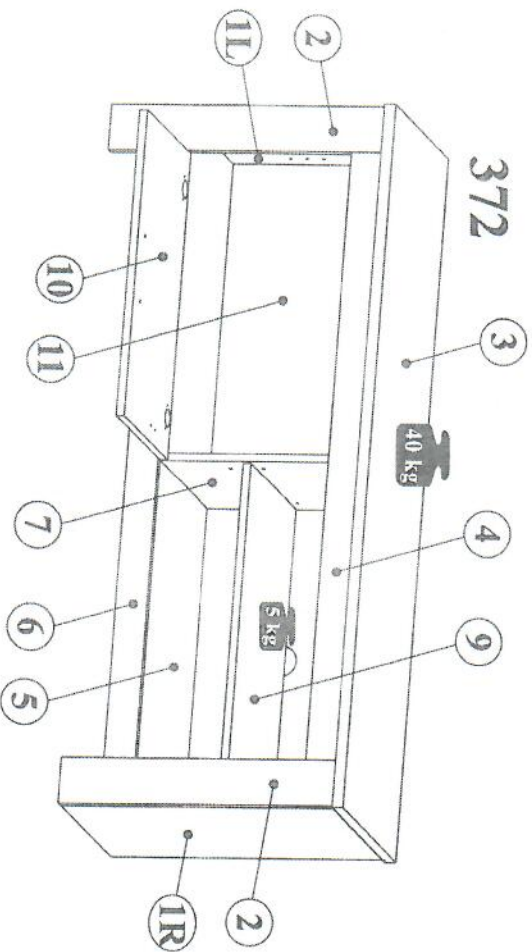
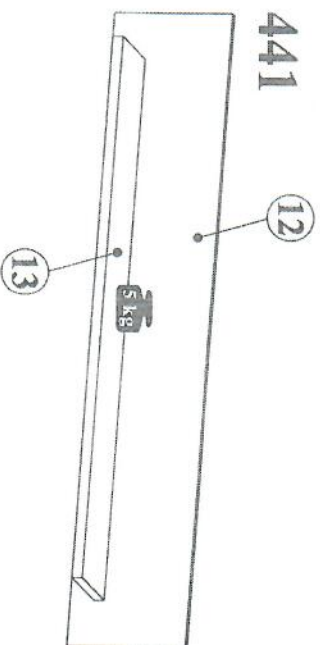
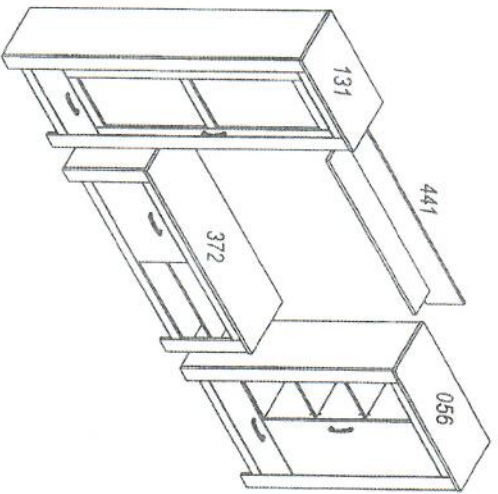













FRIDA P6-FR

372+441









1L,1R	531	376	2	3/3
2	531	90	2	3/3
3	1380	400	1	3/3
4	1192	60	1	3/3
5	1340	356	1	3/3
6	1192	60	1	3/3
7	391	335	1	3/3
9	662	340	1	3/3
10	600	324	1	3/3
11	1349	441	1	3/3
12	1360	250	1	3/3
13	1160	180	1	3/3

372

<p>NR 1</p> <p>B1  ϕ 8x28 X12</p> <p>M1  ϕ 15x12mm X12</p> <p>T1  5x39mm X12</p> <p>C14  ϕ 20mm X2</p> <p>J23  X8</p> <p>S6  3x20 X10</p> <p>W1  X4</p>	<p>NR 2</p> <p>F33  X12</p> <p>P13  3.5x13 X48</p> <p>F15  X4</p>	<p>NR 3</p> <p>Y1  ϕ 3.5 X2</p> <p>D6  H2 X2</p> <p>E3  6.3x13 X4</p> <p>S8  4x13 X4</p>	<p>NR 4</p> <p>R20  X1 kpl</p> <p>S3  3.5x13 X6</p>	<p>NR 5</p> <p>U168  X1</p> <p>P14  3.5x30 X2</p>
--	--	---	--	--

441

<p>NR 1</p> <p>K2  7x70 X5</p> <p>F50  X2</p> <p>E2  6x8 X4</p> <p>T10  X2</p> <p>L1  QUE 15M X1</p> <p>C18  5mm X2</p>
--



FRIDA P6-FR 372+441

1 Type: 372

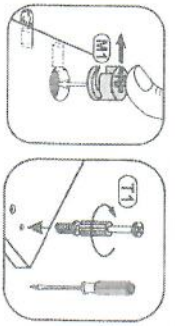

E33		X4
B1		X4
M1		X4
T1		X4
W1		X2
P13		X8

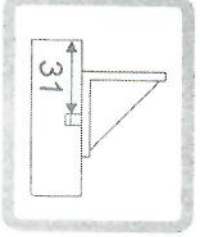
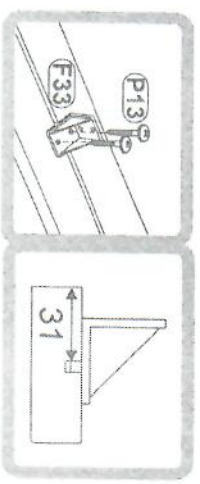
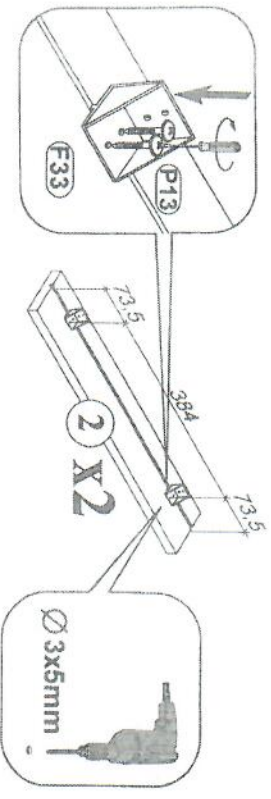
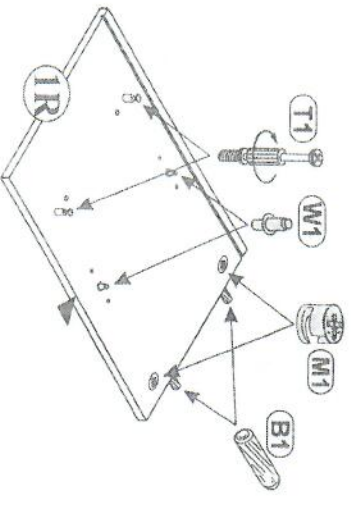
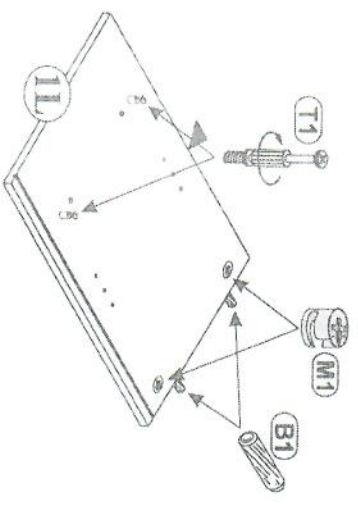

2

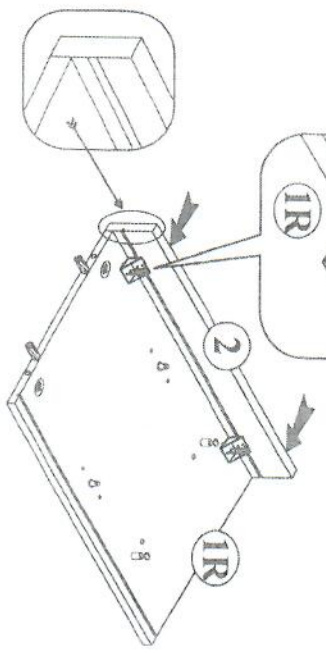
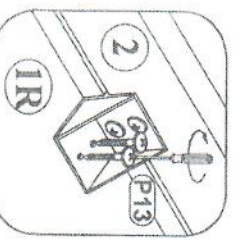
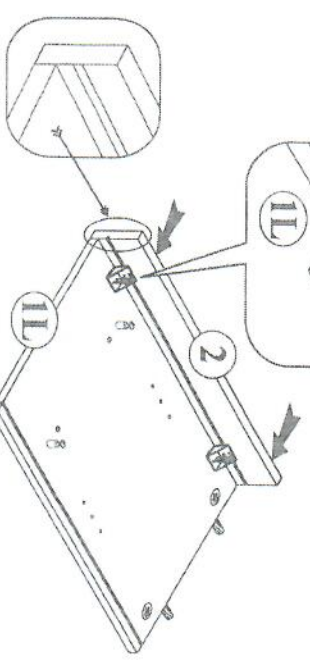
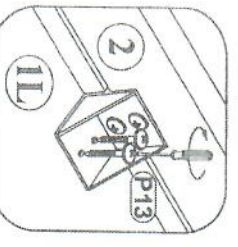

P13		X8
------------	--	----

FRIDA P6--FR 372+441

3

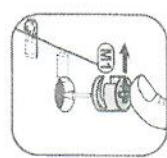
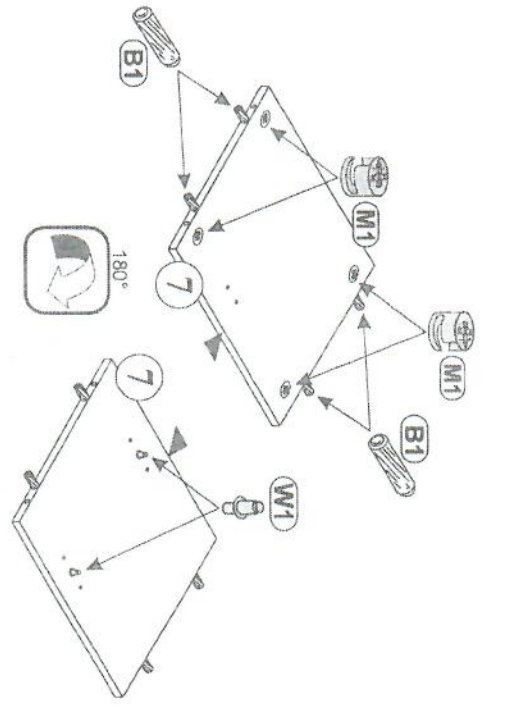

B1		Ø 8x28	X4
M1		Ø 1.5x12mm	X4

F33		X8
P13		3.5x13 X16
W1		X2

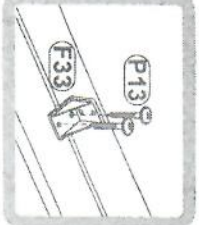
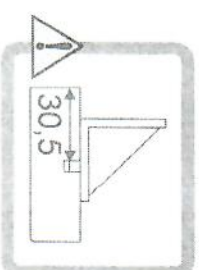
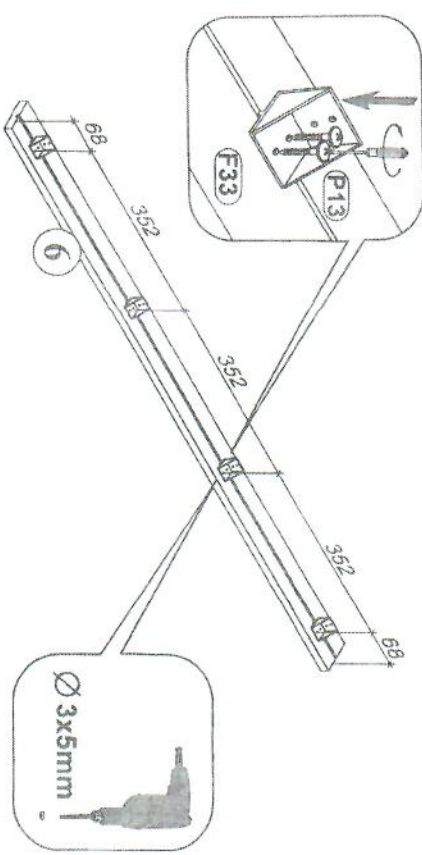
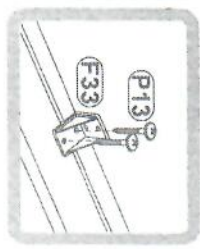
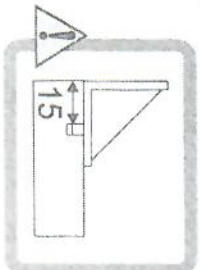
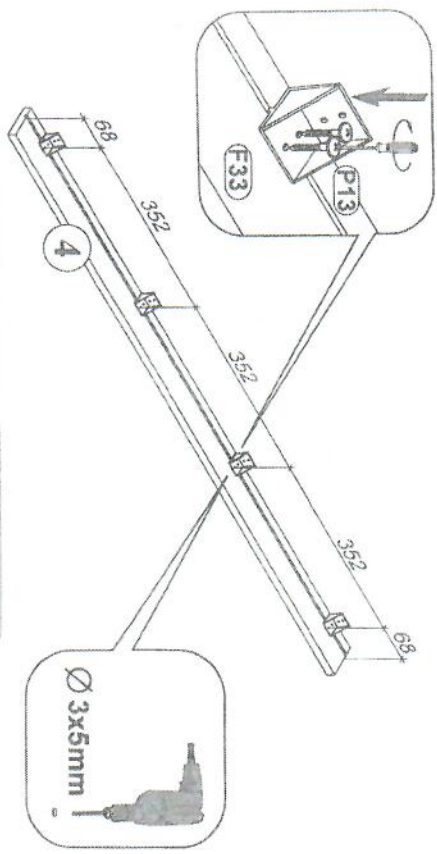

FRIDA P6--FR 372+441

6 / 13

4

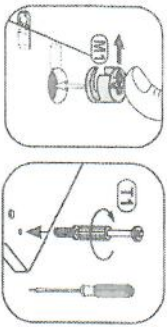
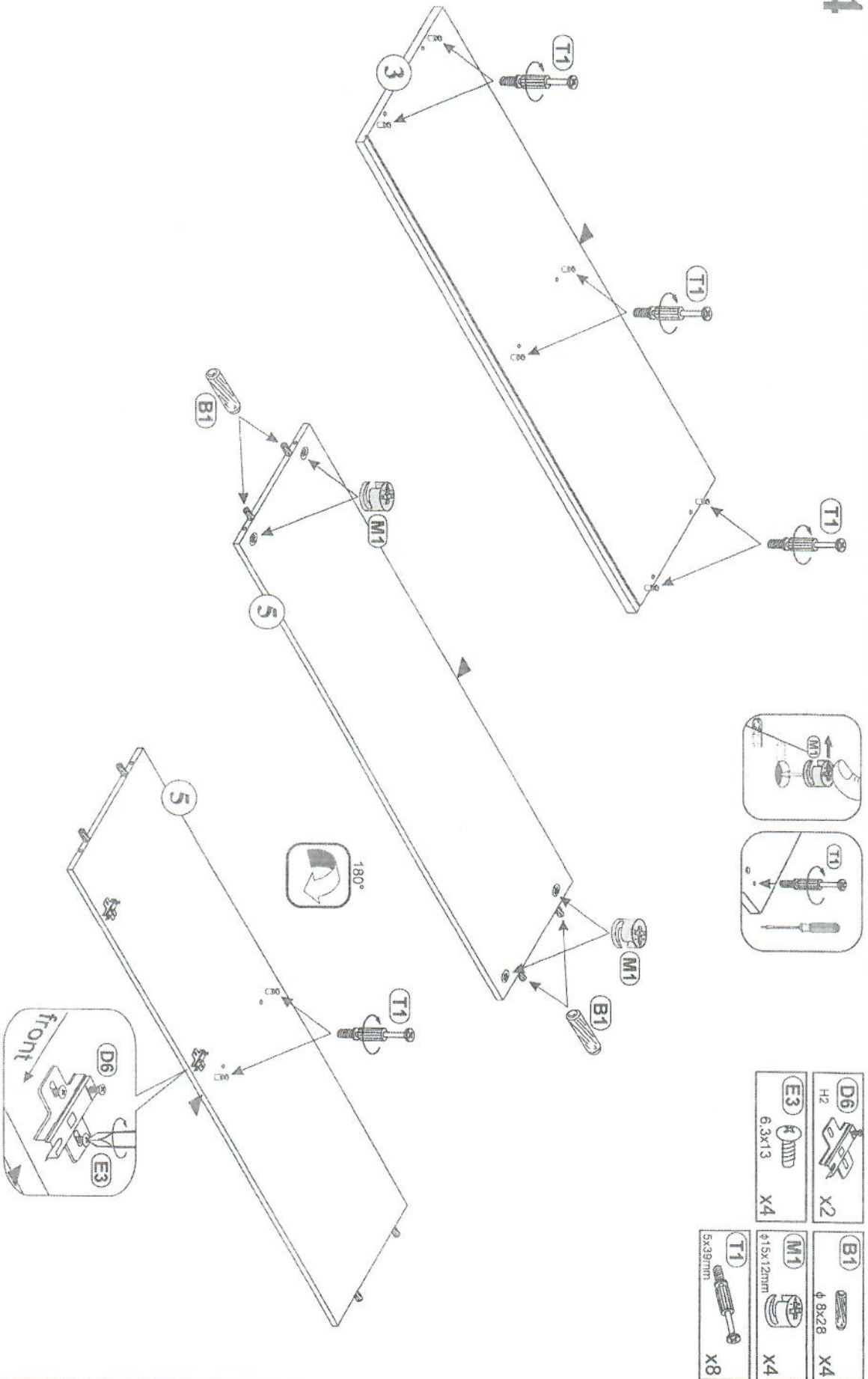

D6		X2
E3		X4

B1		X4
M1		X4
T1		X8

5

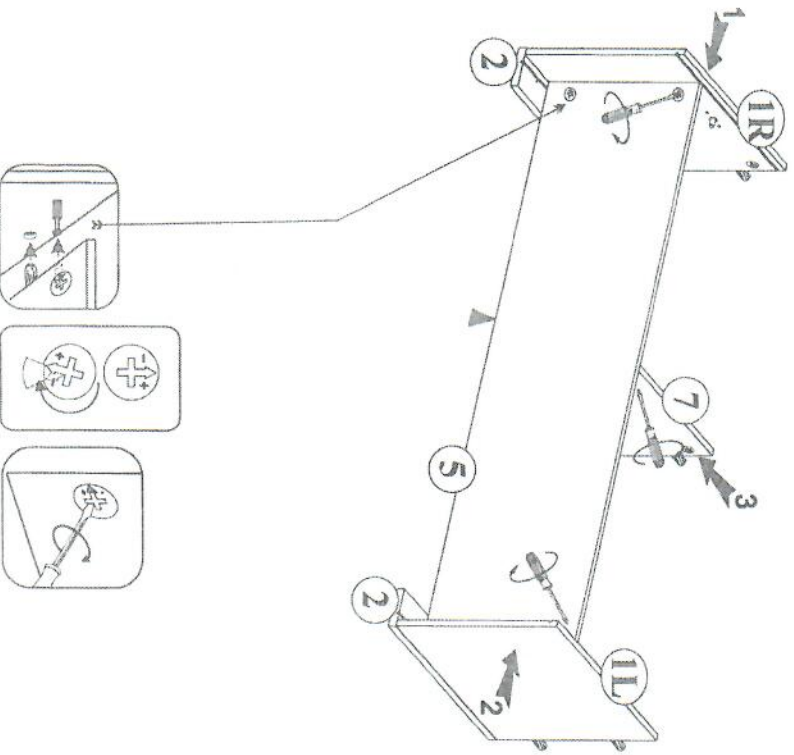

6

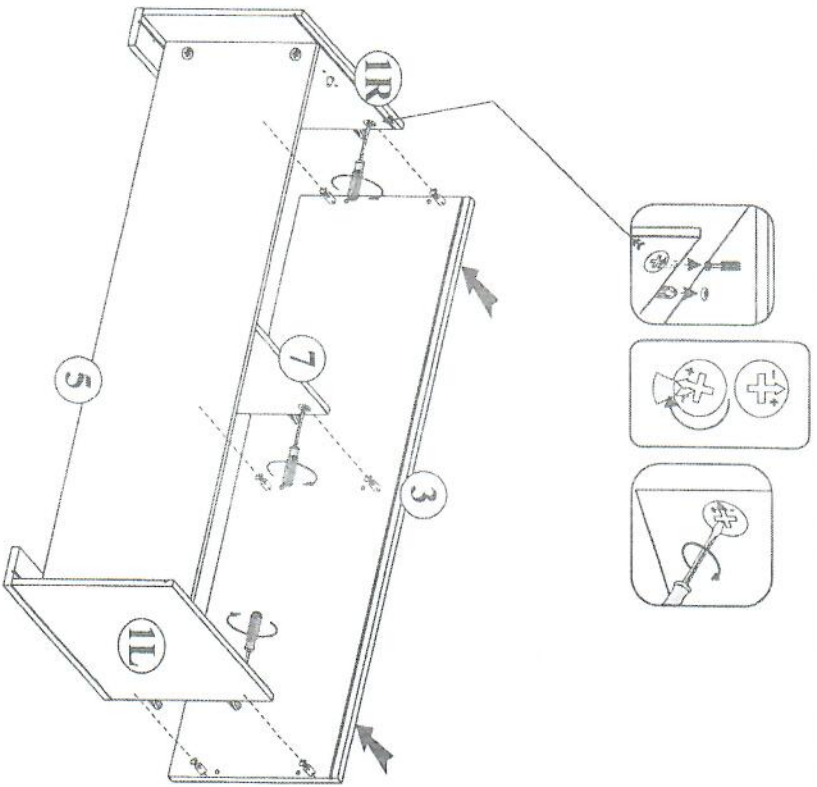

FRIDA P6--FR 372+441

7

- S6 4x20 X10
- J23 X8

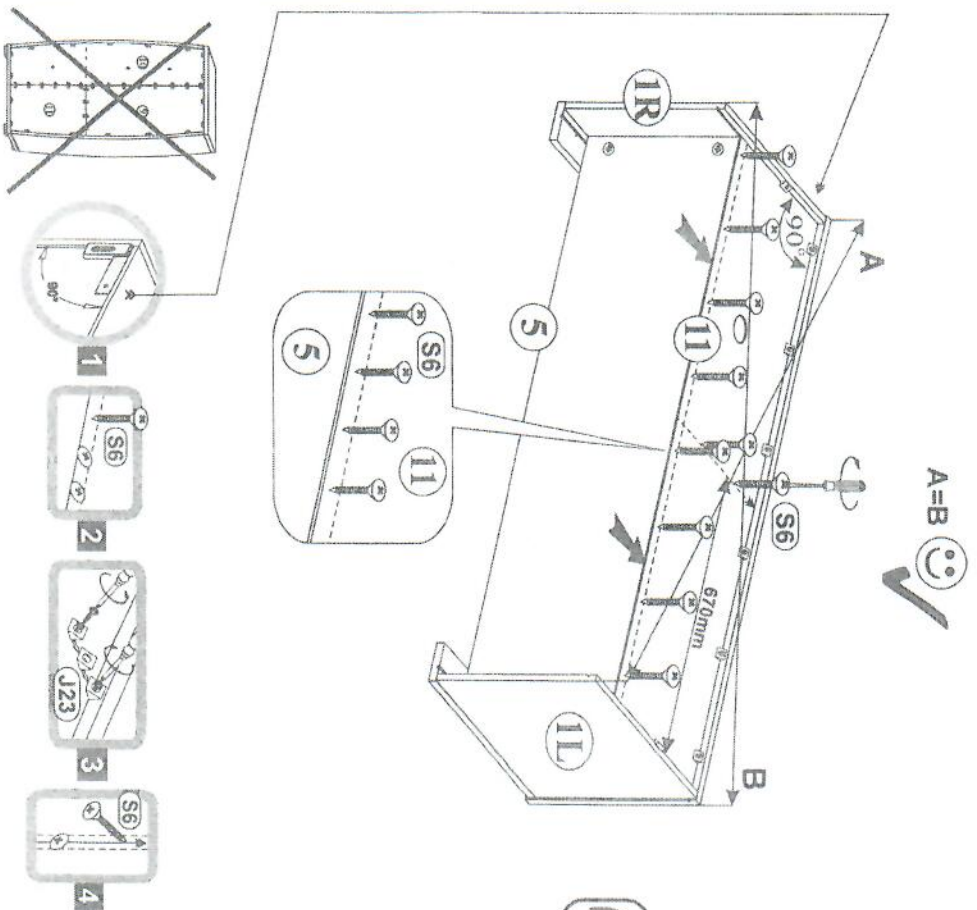

8

- P13 3.5x13 X16
- F15 X4

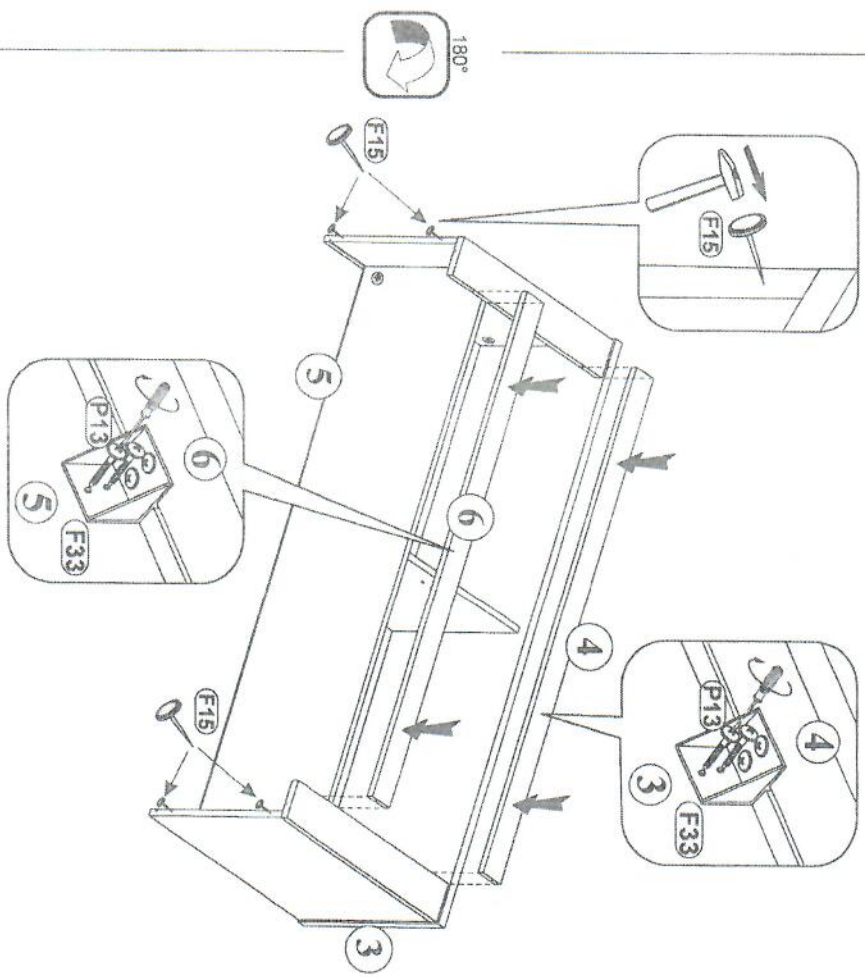

9

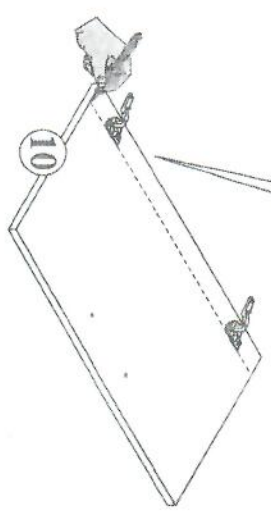
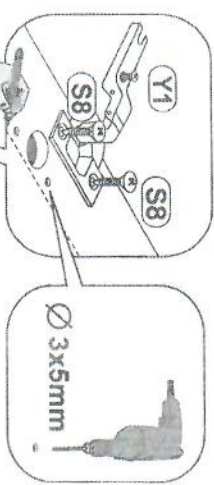
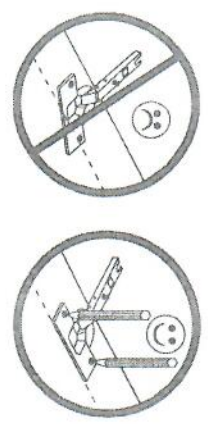
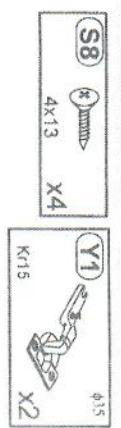

10

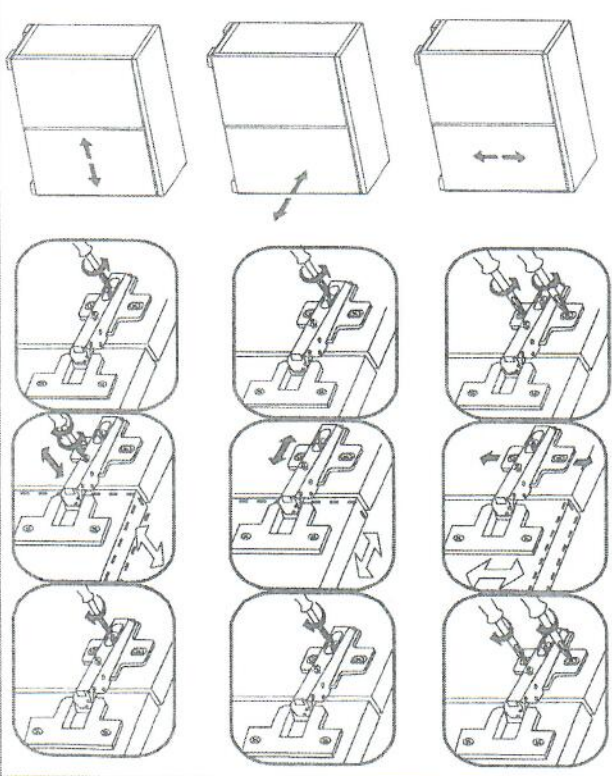
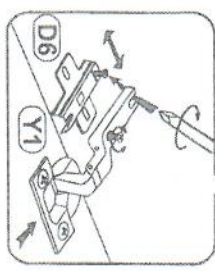
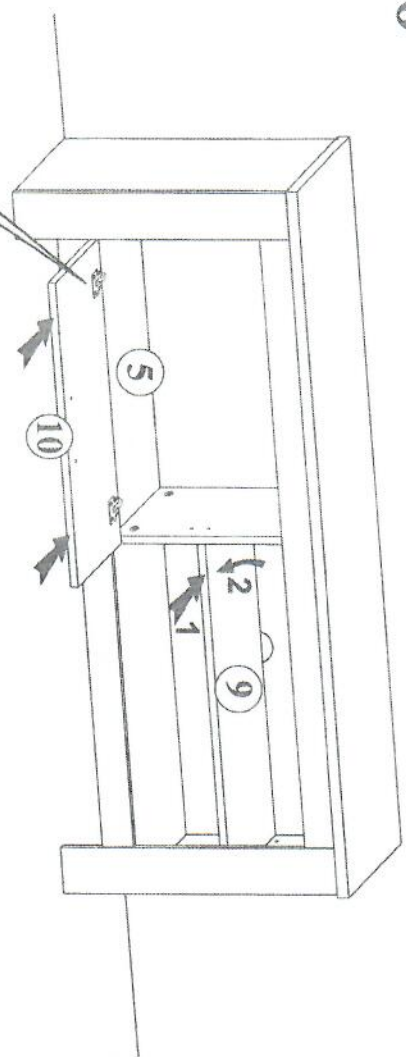

11

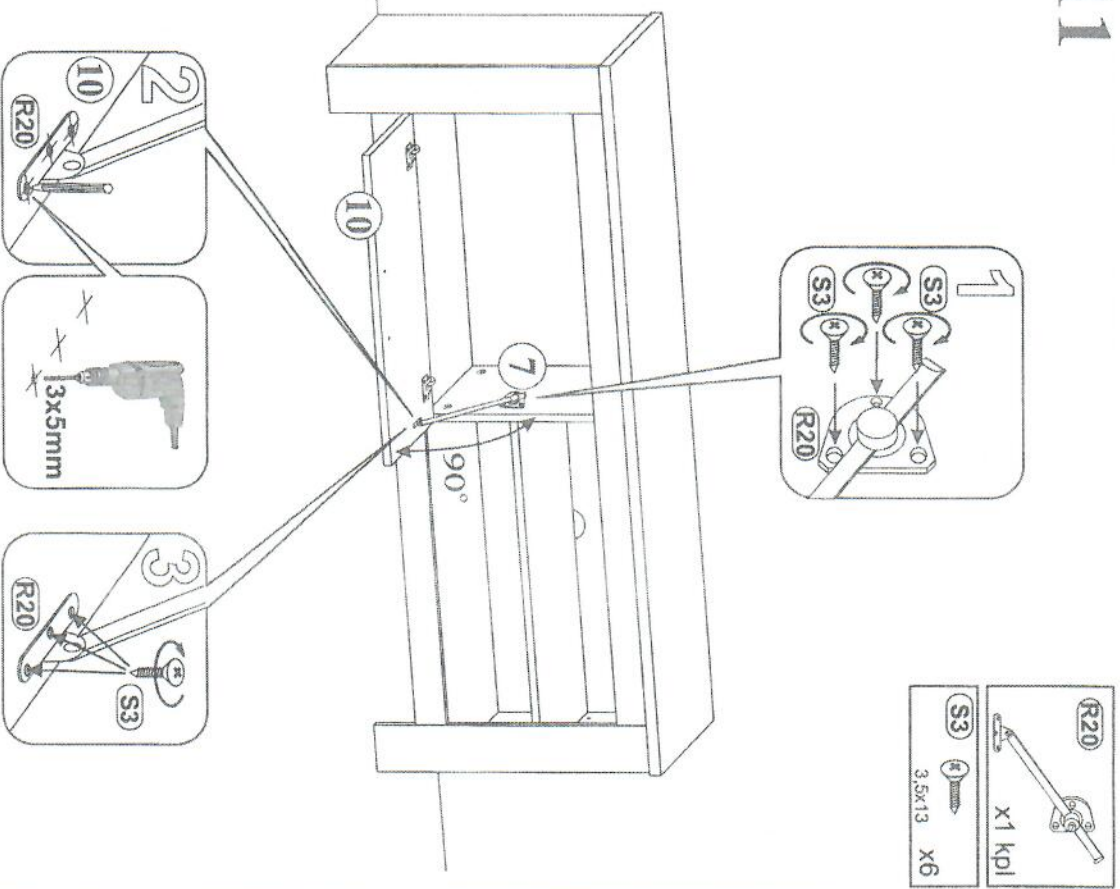

- R20** x1 kpl
- S3** 3.5x13 X6

12

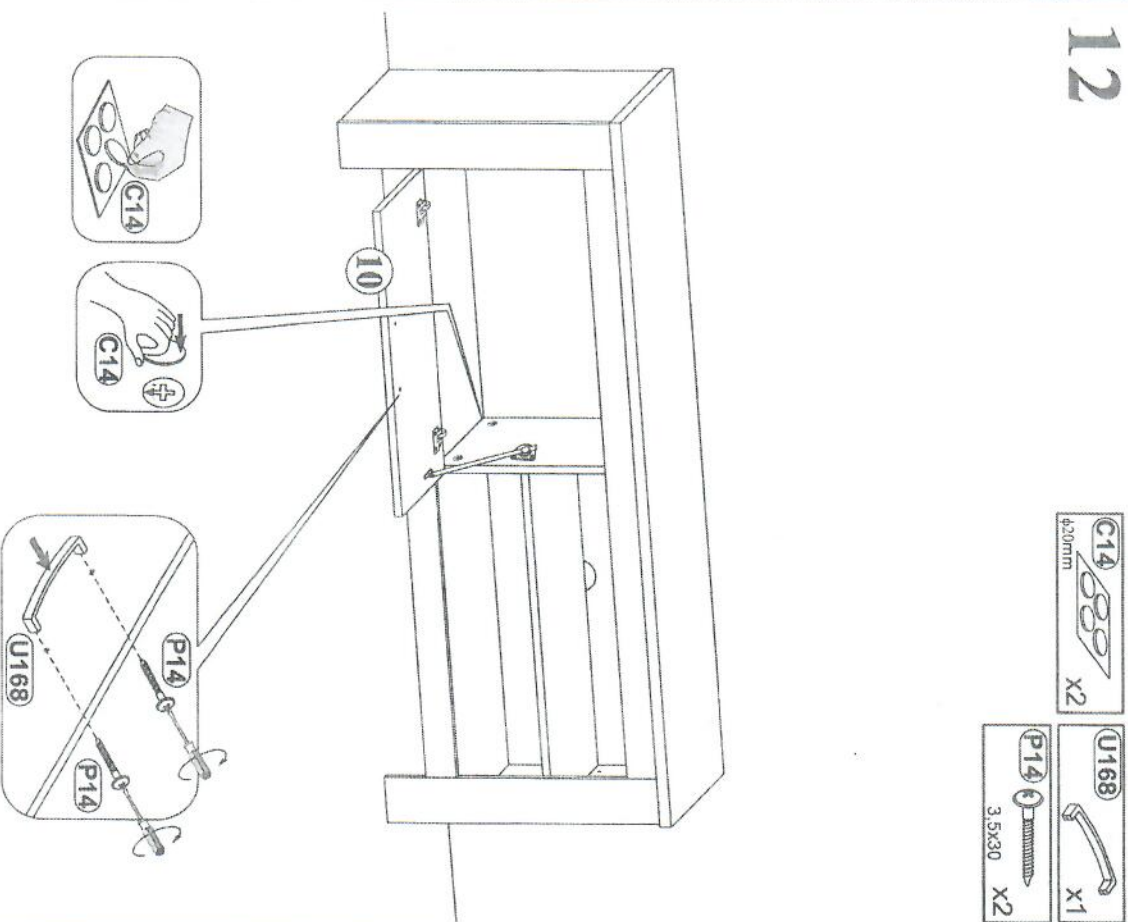

- C14** h:20mm X2
- P14** 3.5x30 X2
- U168** X1

13 Type: 441

(F50)		x2
(E2)		x4
(L1)		x1
(C18)		x2

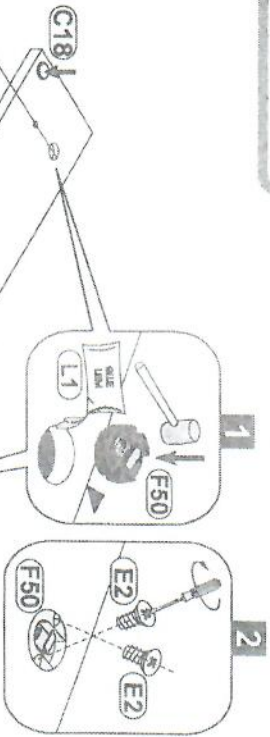
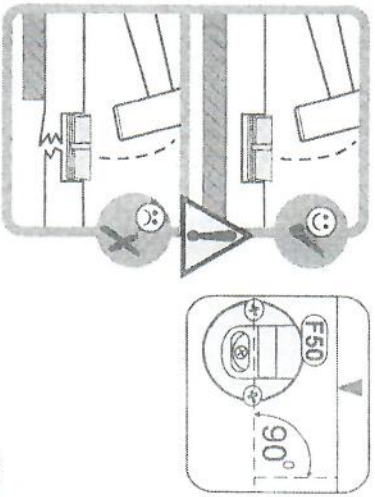

14

(K2)		x5
------	--	----

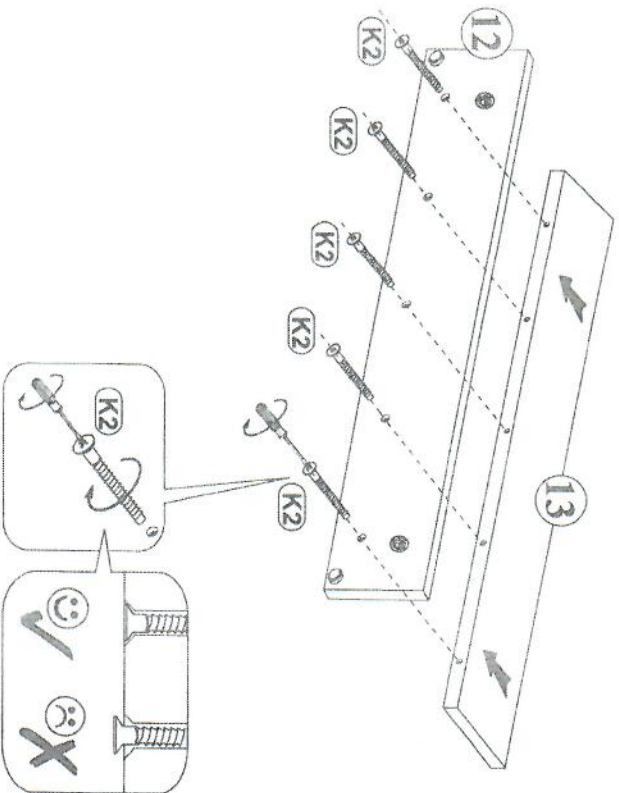

15

