

# N61-LAW 110

A	B	C		D
1	N61-150	235	648	1/1
2	N61-134	235	350	1/1
3	N61-152	438	235	1/1
4	N61-227	1040	648	1/1
5	N61-228	1040	648	1/1
6	N61-541	191	60	1/1
7	N61-589	1040	60	1/1
8	N61-590	1040	60	1/1
9	N61-560	681	60	1/1
10	N61-591	1040	60	1/1
11	N61-592	1040	60	1/1
12	N61-443-01	901	100	1/1
13	N61-444-01	558	100	1/1

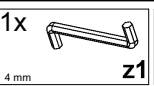

# 1

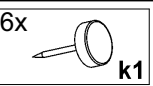
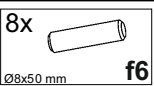
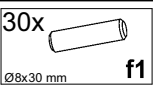
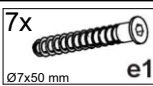
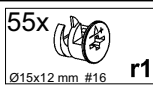
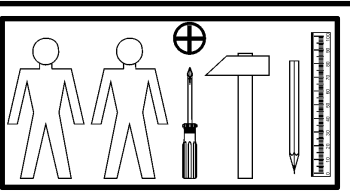
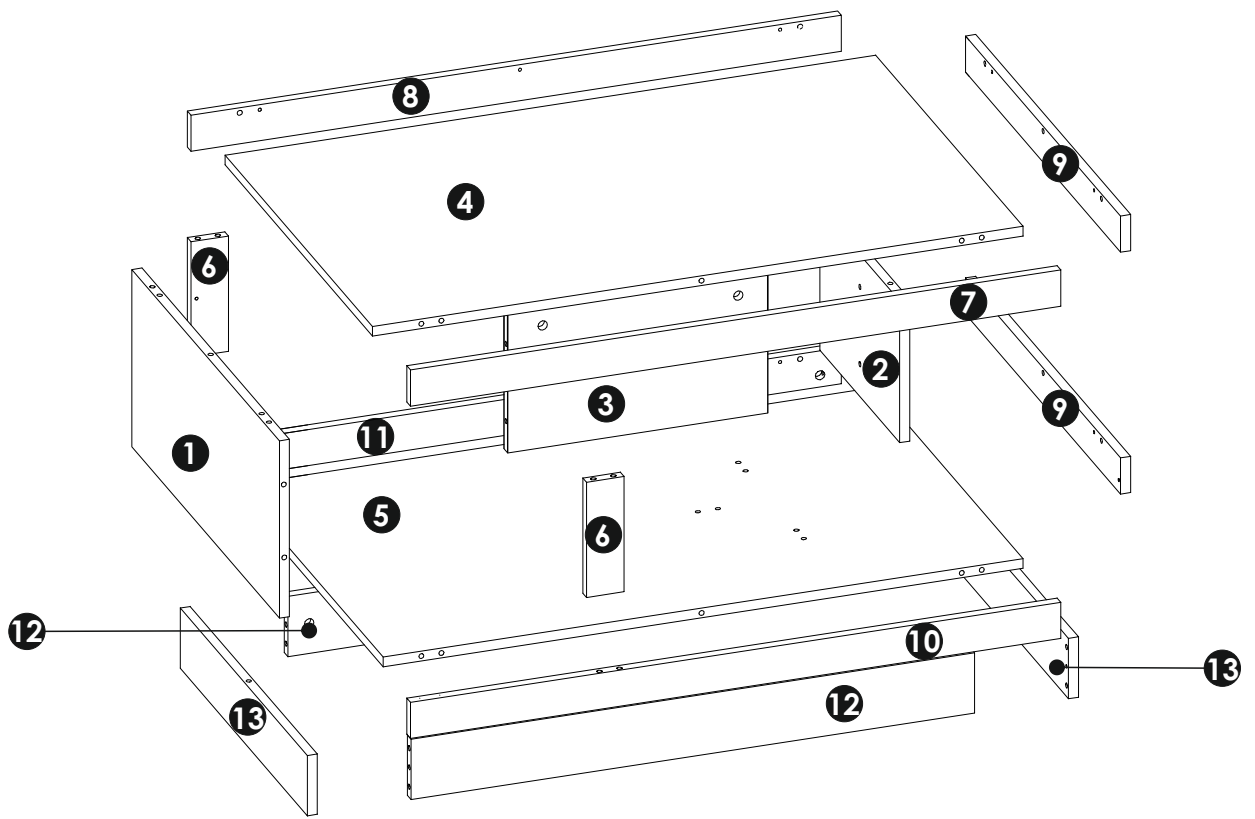
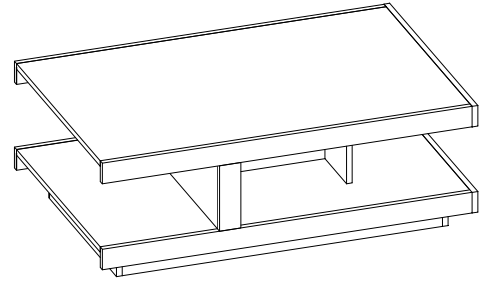
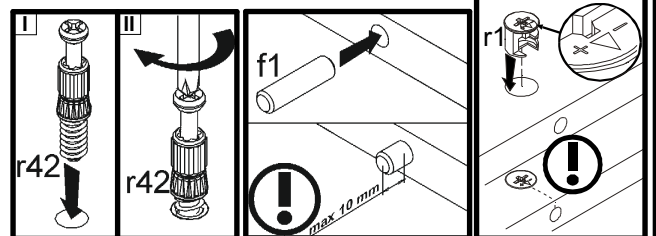
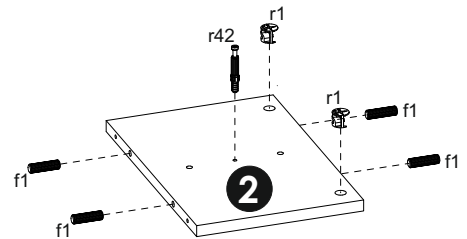
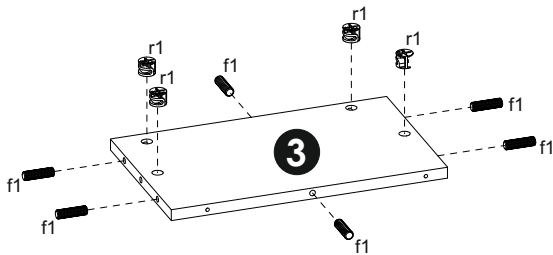
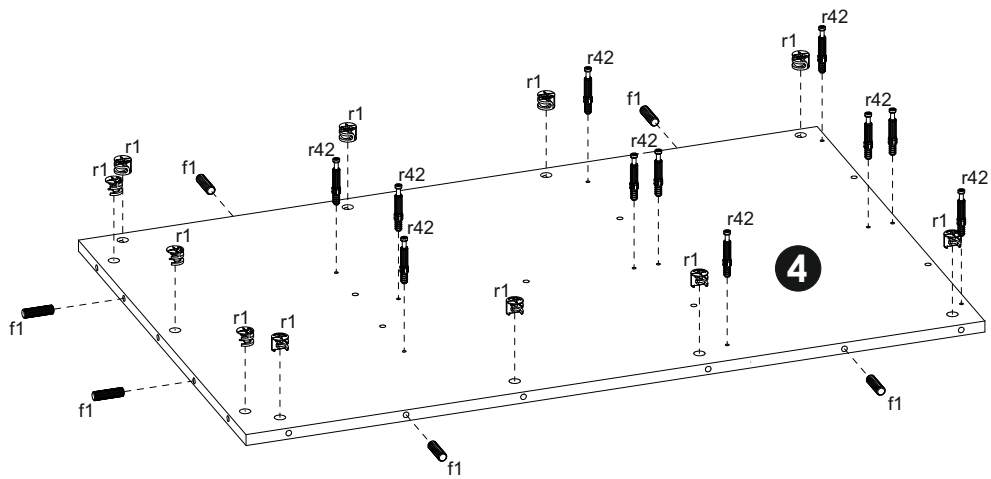
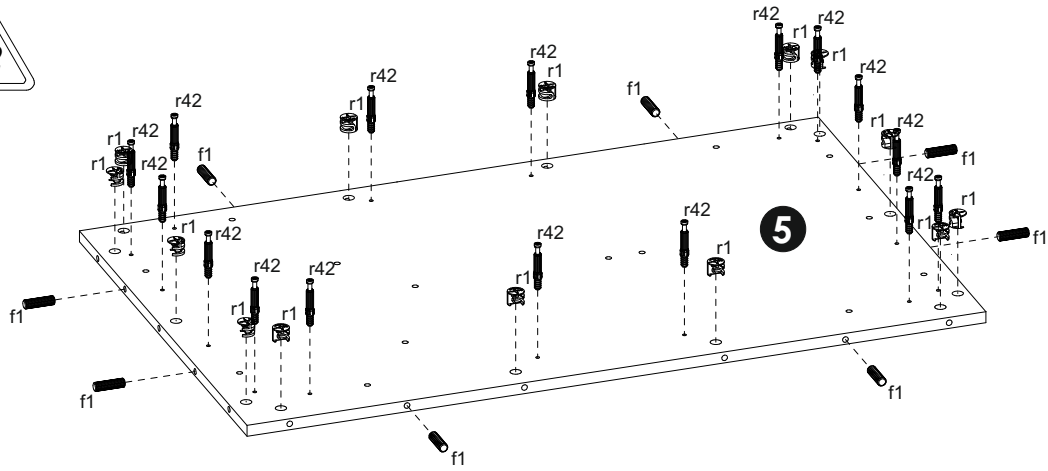

# 2

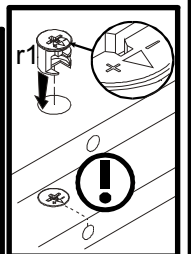
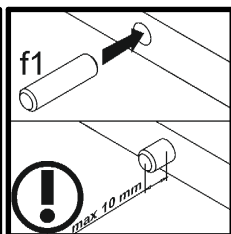
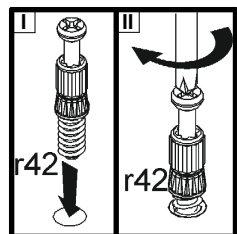
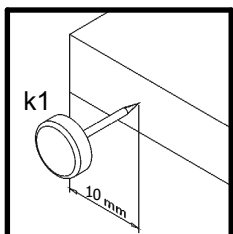
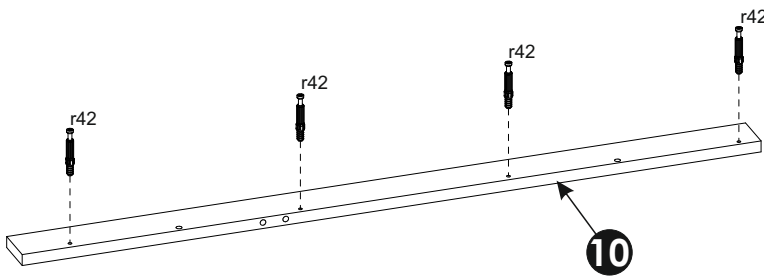
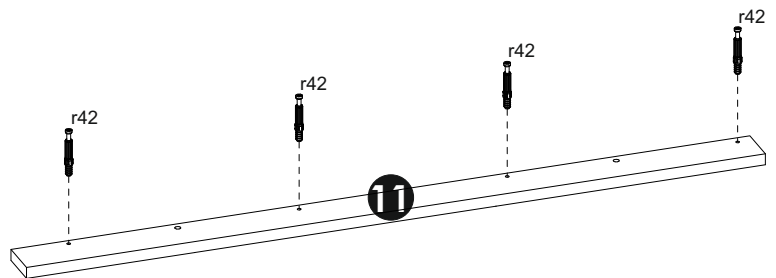
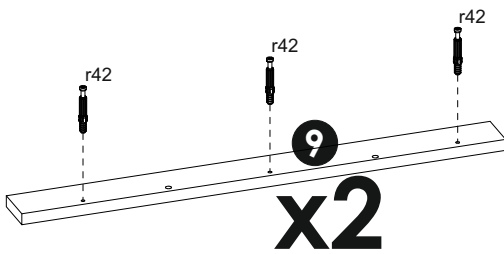
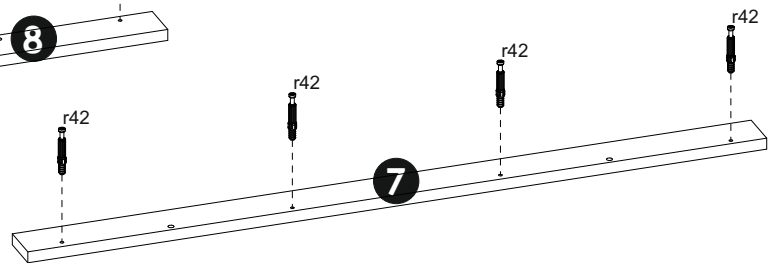
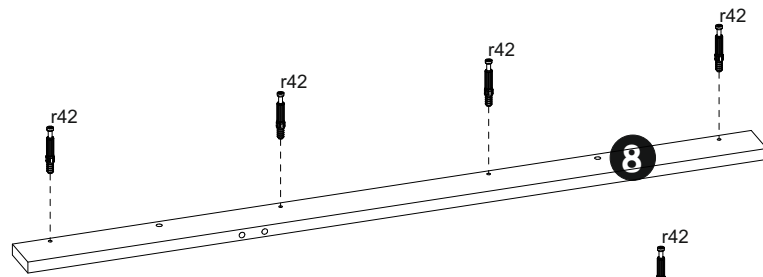
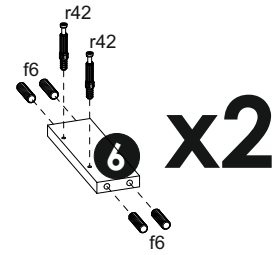
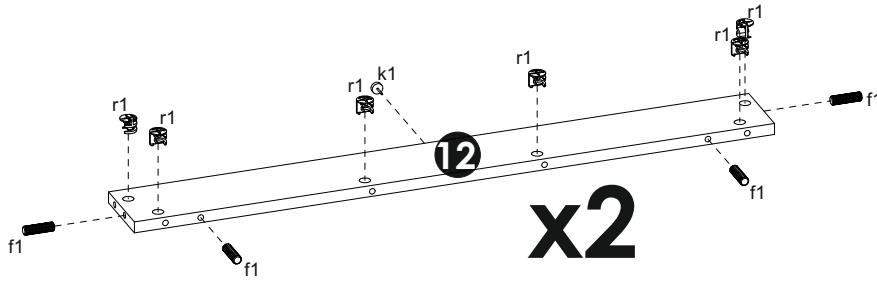
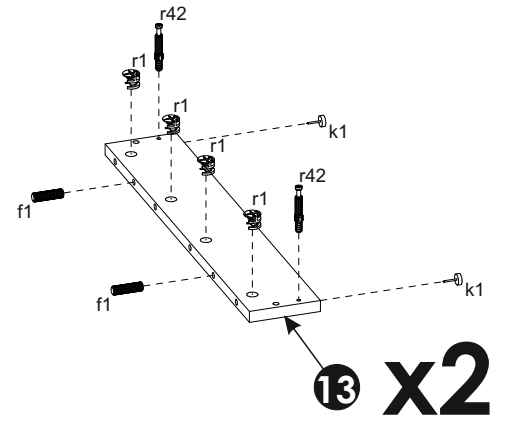
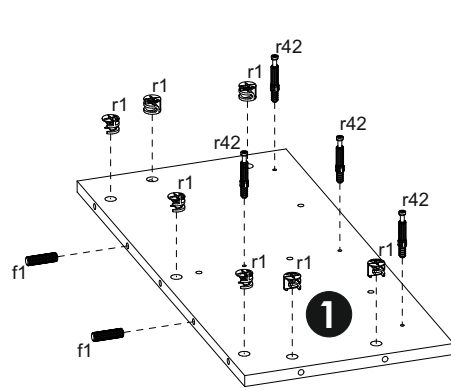

# 3

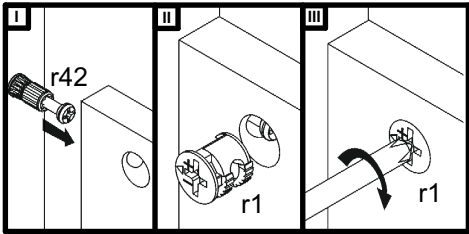
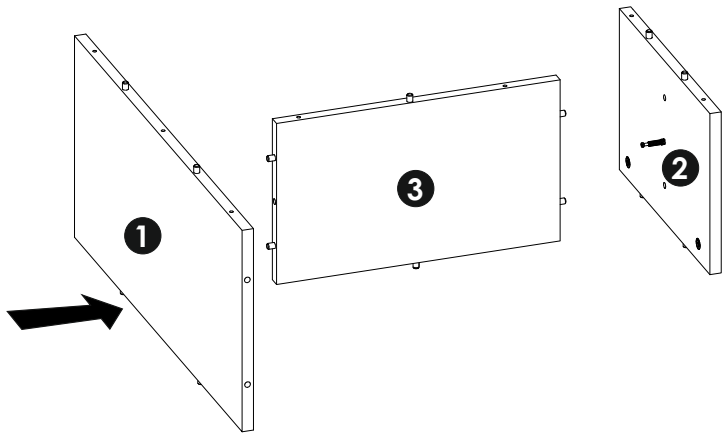

# 4

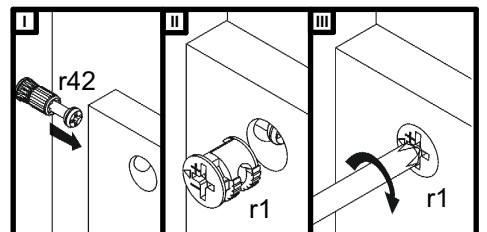
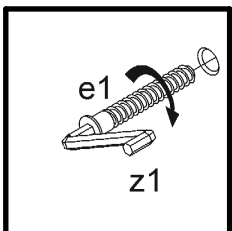
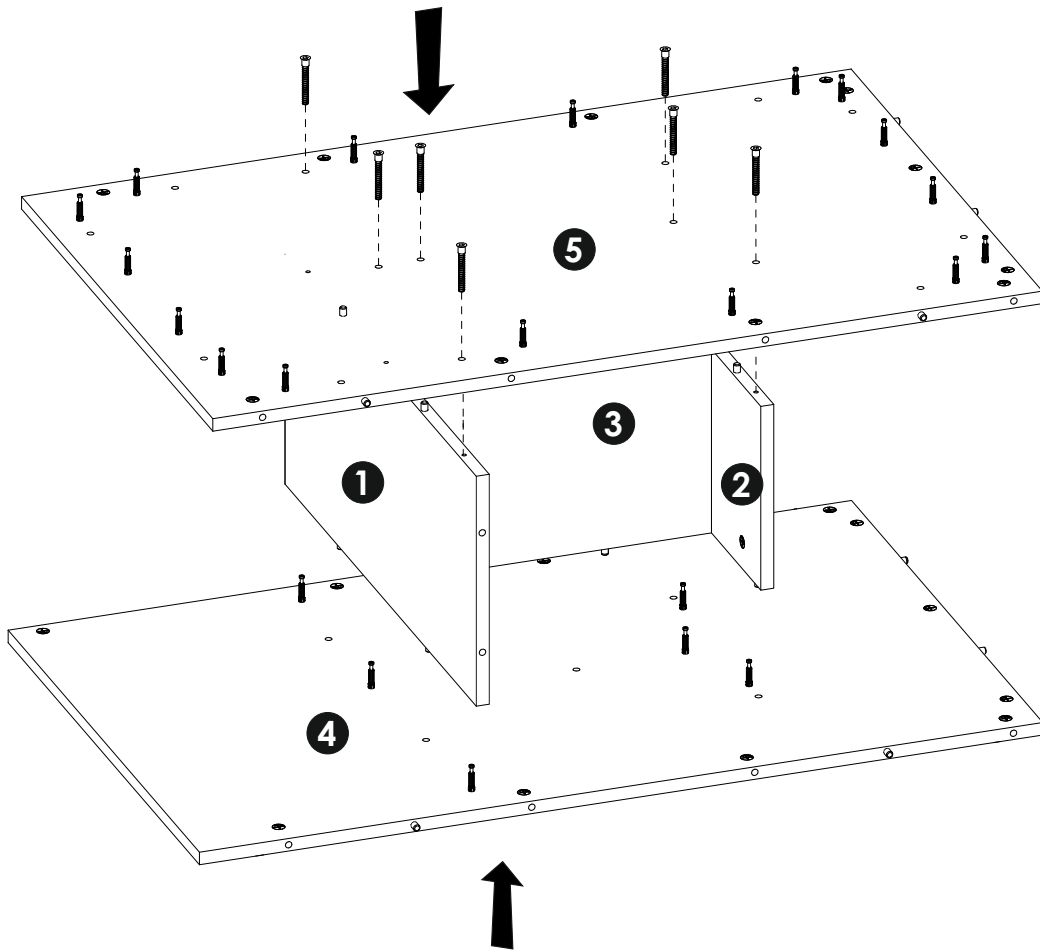

# 5

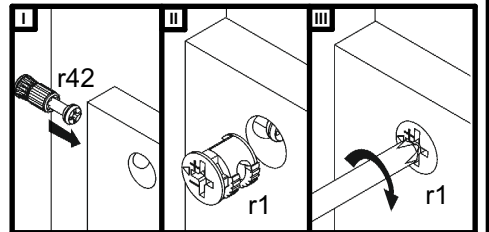
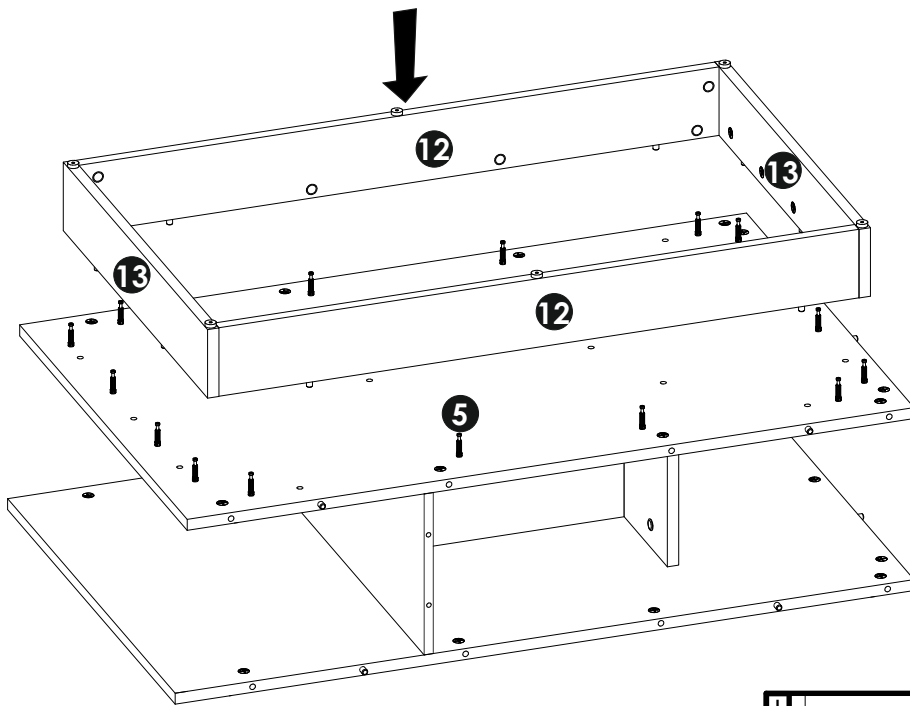
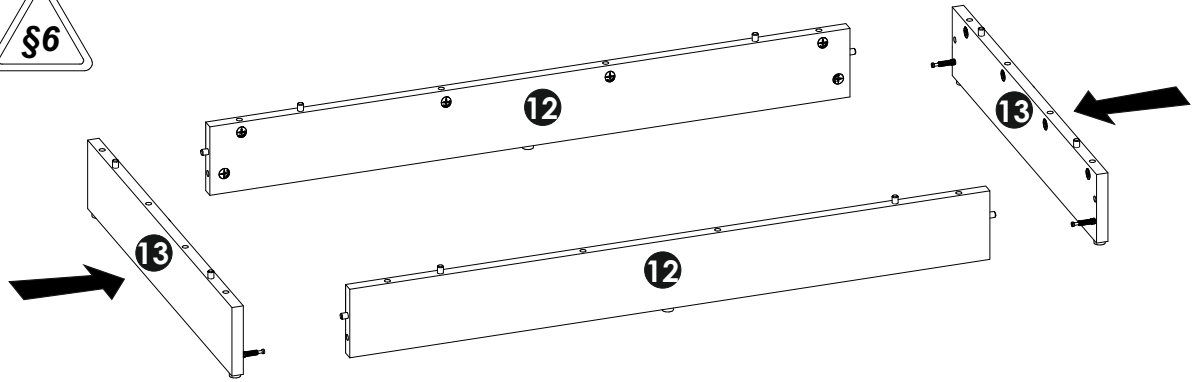

# 6

