

A	B	C		D
1	MS1-5532	1378	896	1/3
2	MS1-5535	957	60	2/3
3	MS1-212	958	61	2/3

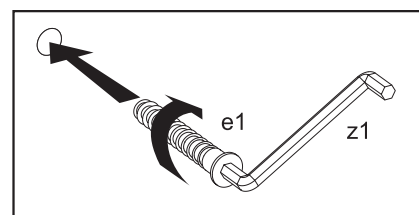

# 2

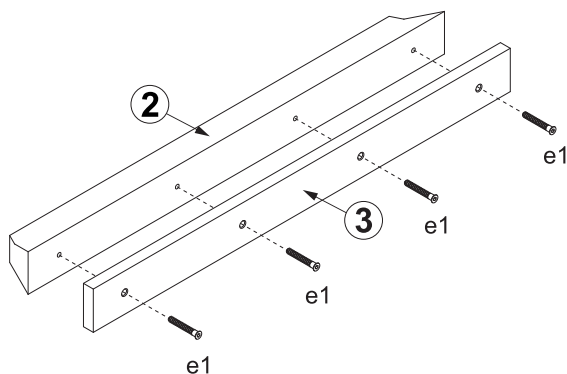
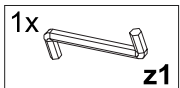
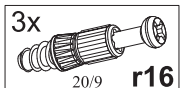
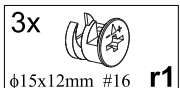
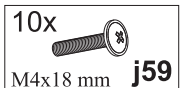
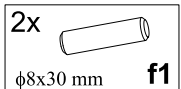
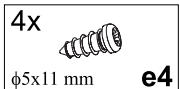
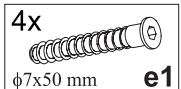
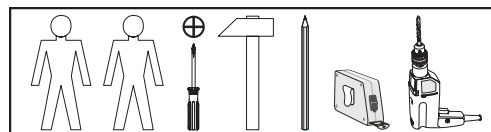
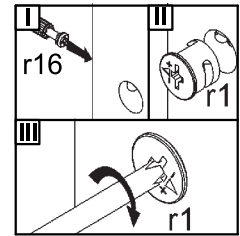
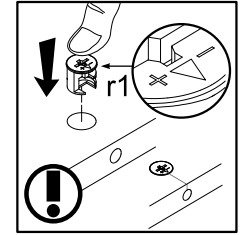
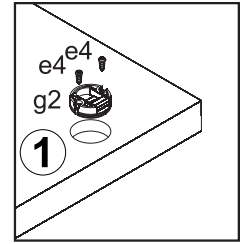
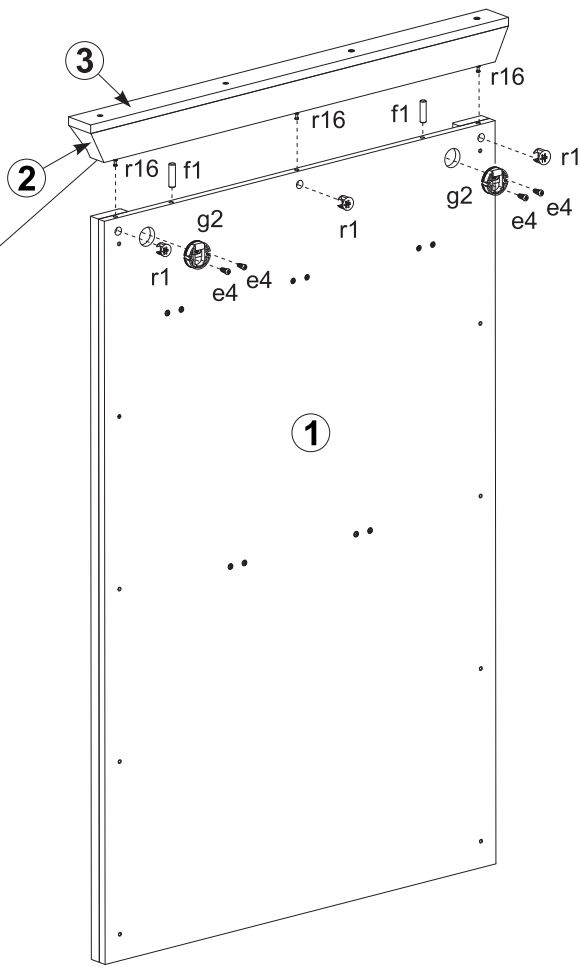
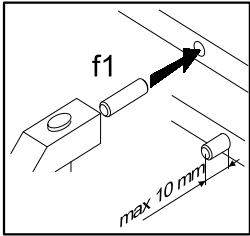
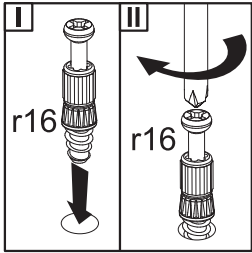
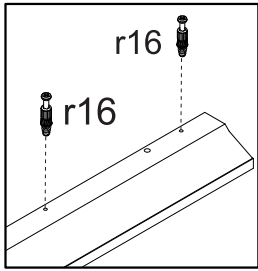

# 3

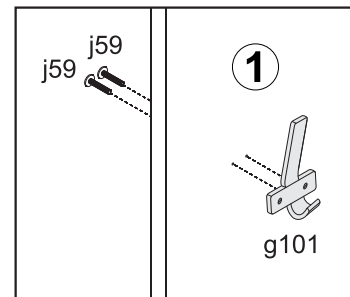
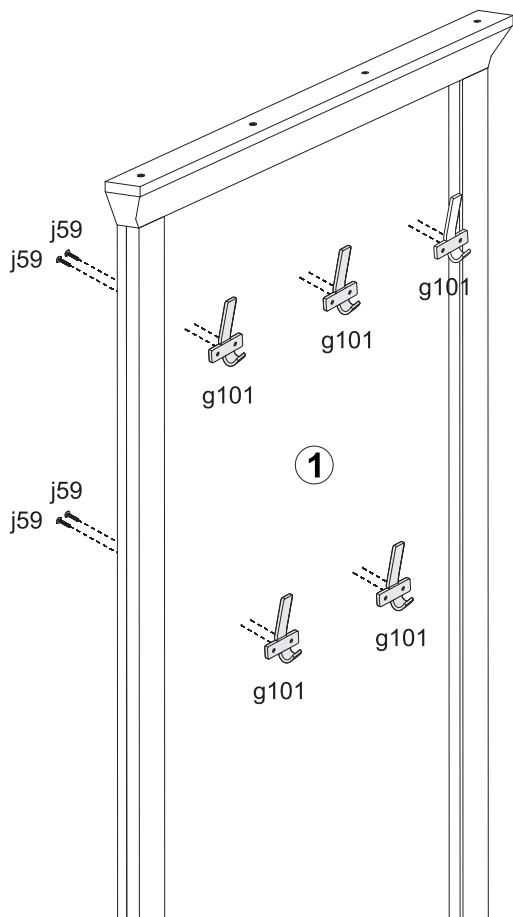

# 4

