

ВУШЕР

Комод **KOM 1W2D2S**

A	B	C	D	A	B	C	D		
1	S154-005	906	496	3/3	11	S154-207	1499	430	1/3
2	S154-009	496	146	3/3	12	S154-307-01	482	400	2/3
3	S154-010	496	756	3/3	13	S154-308	475	400	2/3
4	S154-011	496	756	3/3	14	S154-507	350	100	2/3
5	S154-012	496	146	3/3	15	S154-508	350	100	2/3
6	S154-109	878	430	2/3	16	S154-509	435	100	2/3
7	S154-110	878	430	2/3	17	S154-908	888	500	3/3
8	S154-111	878	410	2/3	18	S154-909	450	348	2/3
9	S154-112	878	410	2/3	19	S154-910	888	488	3/3
10	S154-206	1499	430	1/3	20	qb20\1	LED		2/3

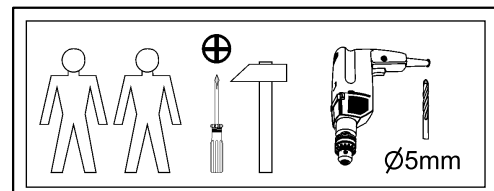
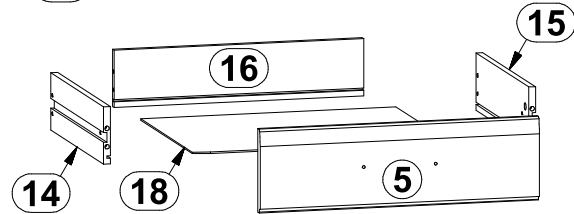
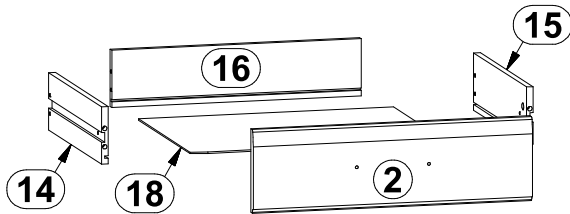
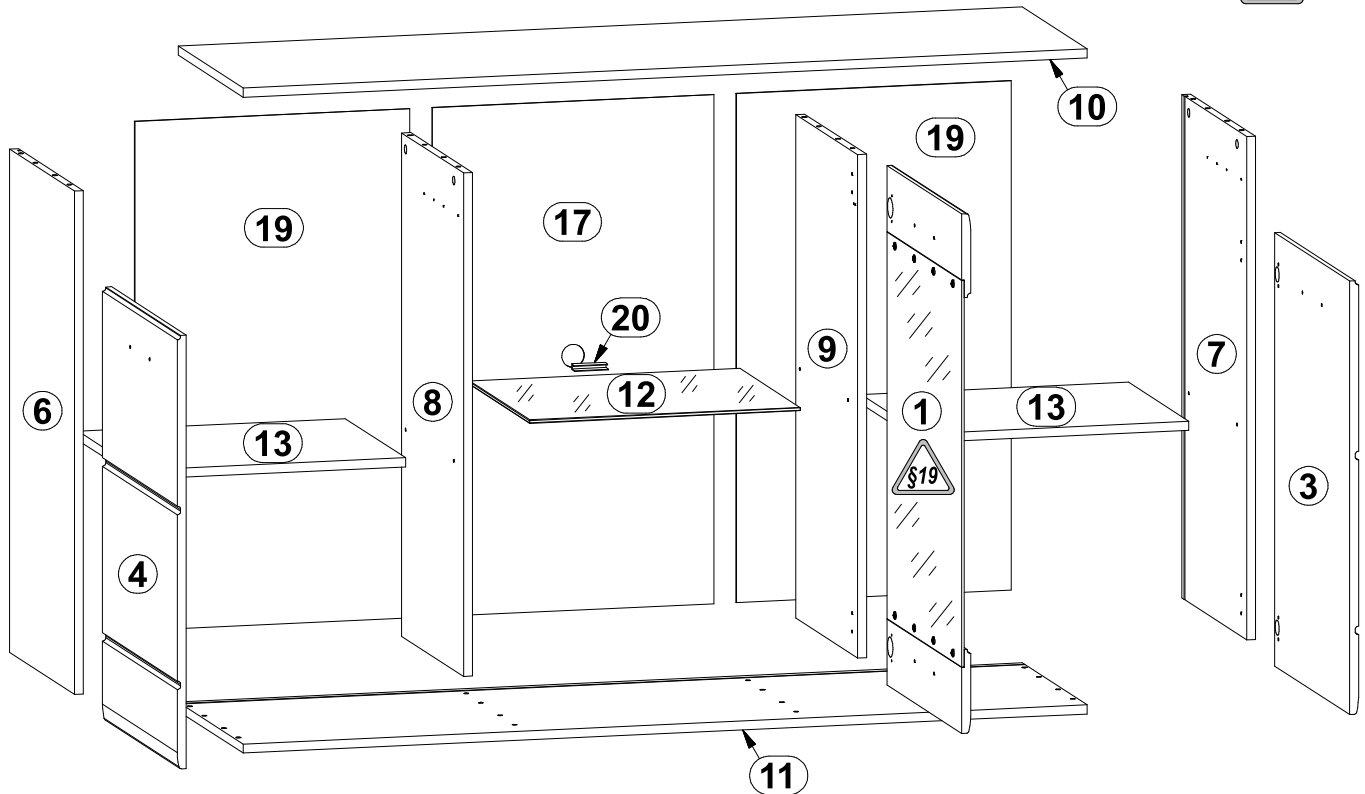
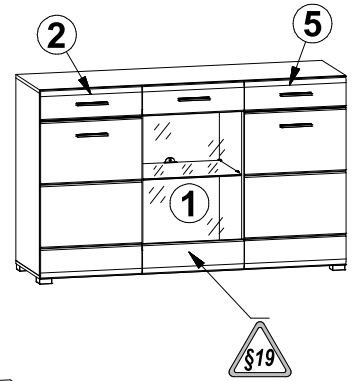

4x a2	2x a68	4x b1	2x b35	5x c253\3	8x d1	4x d3	8x e1	8x e32
16x f1	4x j3	5x k55	40x l1	26x l2	1x m32	1x m34	4x o21	18x p1
4x p51	10x p6	10x p9	8x r1	8x r15	16x r16	6x s4	1x s53	1x s53
4x w4	1x n26\1	1x p38	1x z1					

1

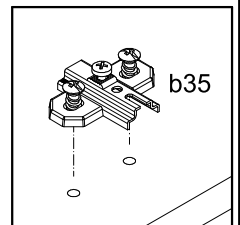
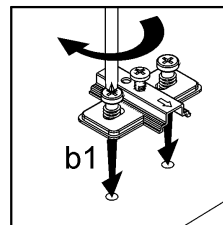
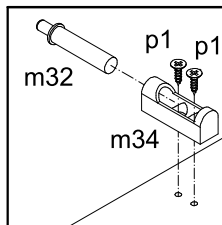
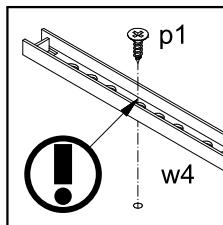
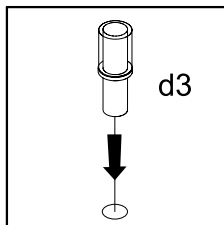
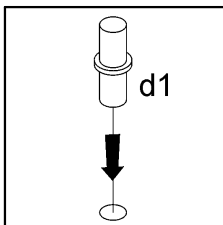
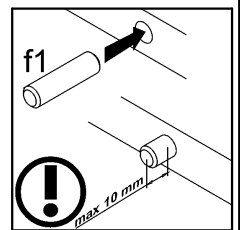
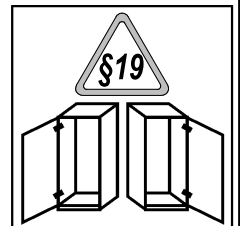
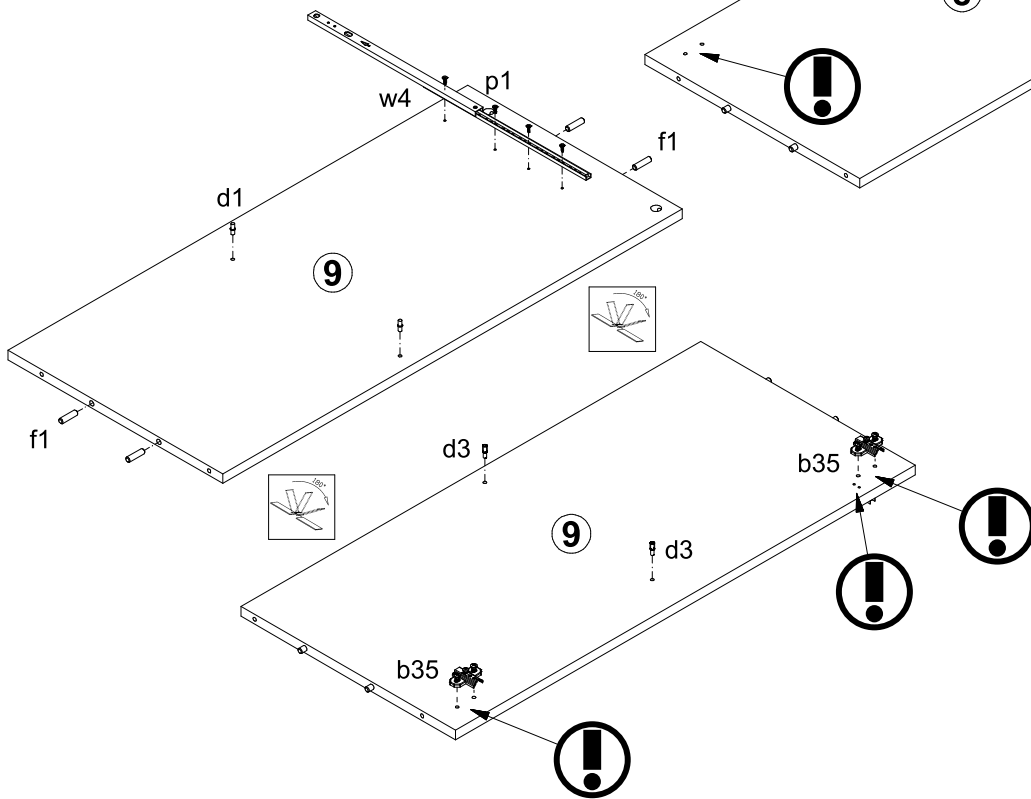
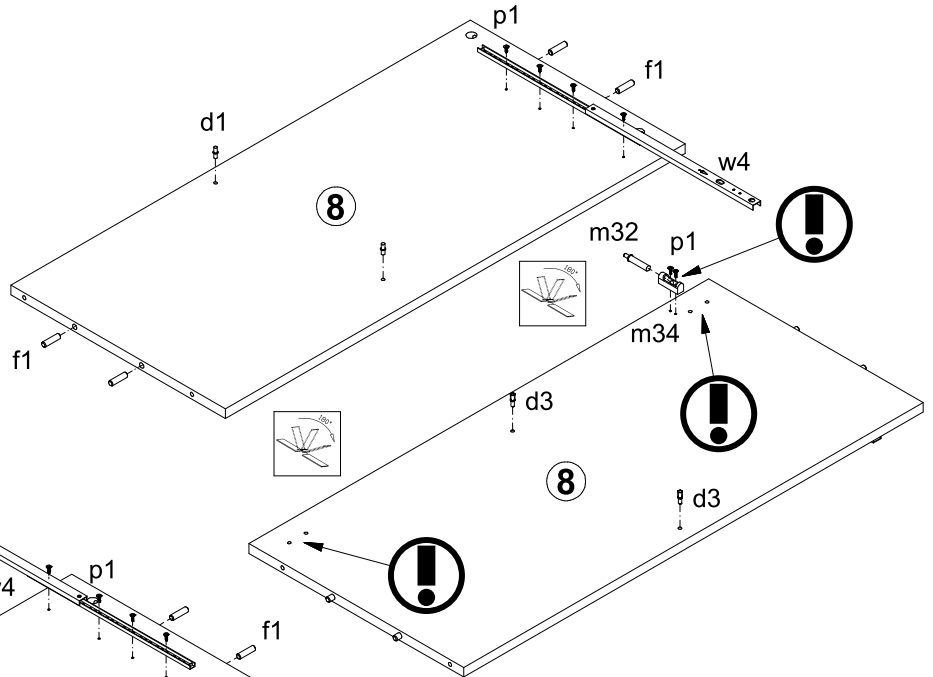
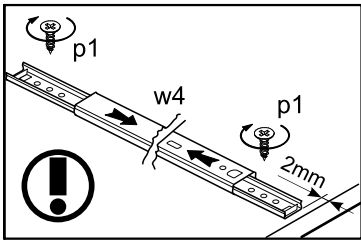
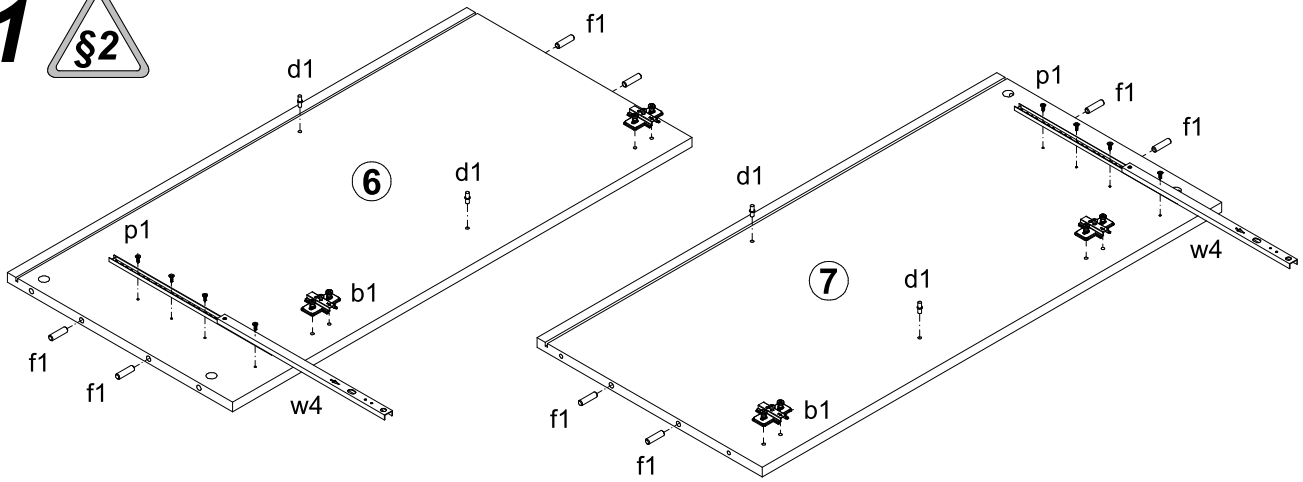

2

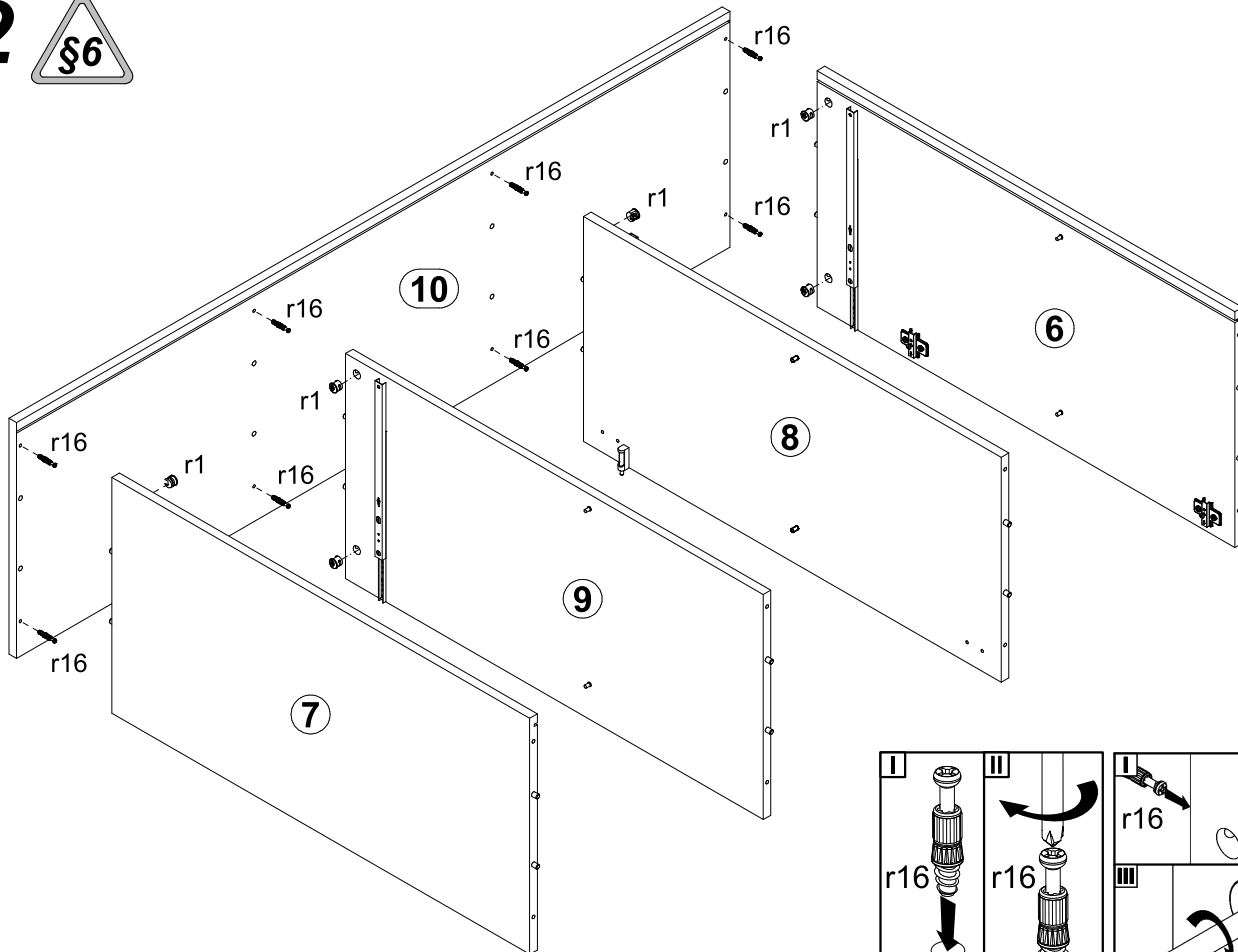

3

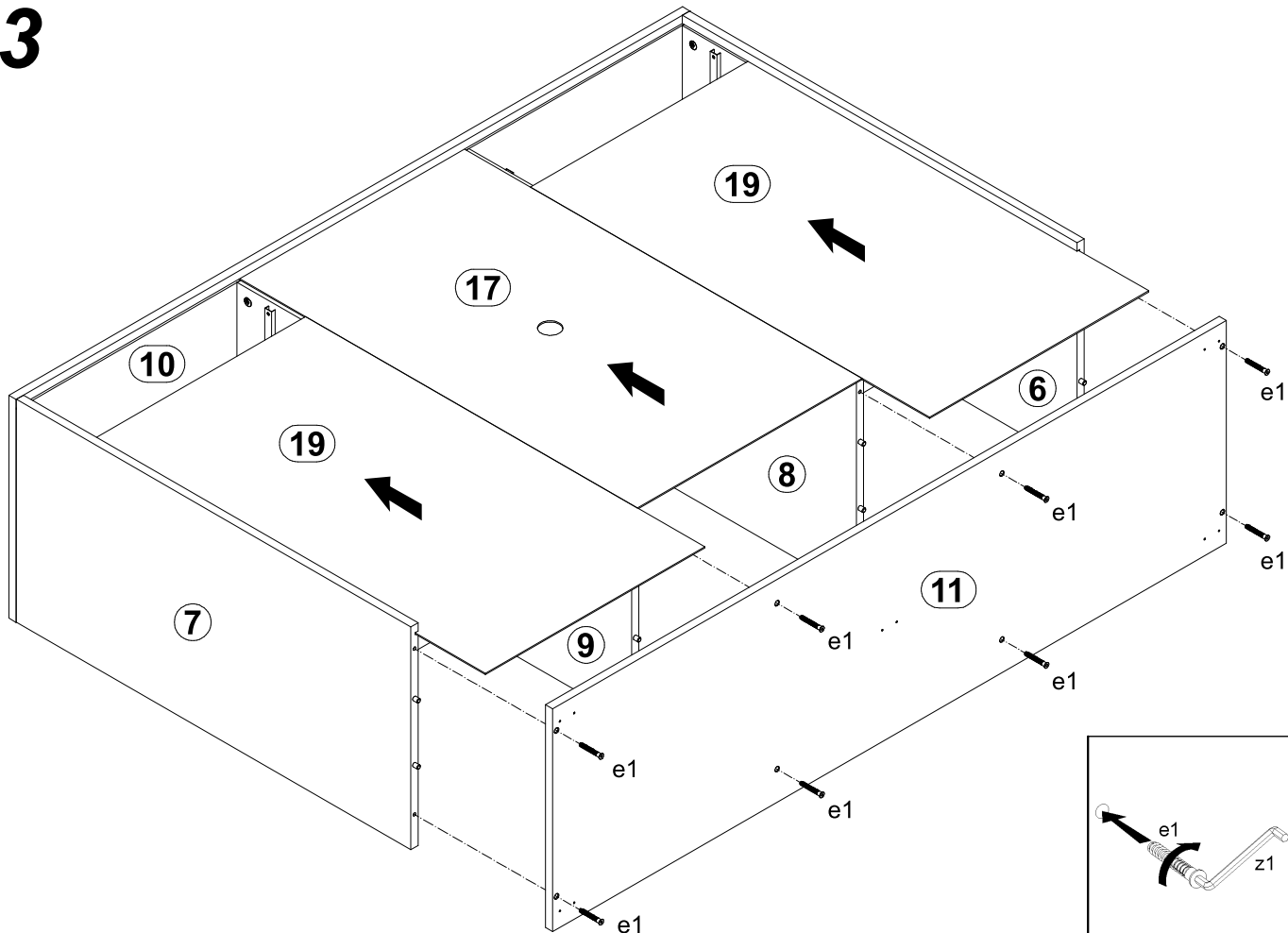

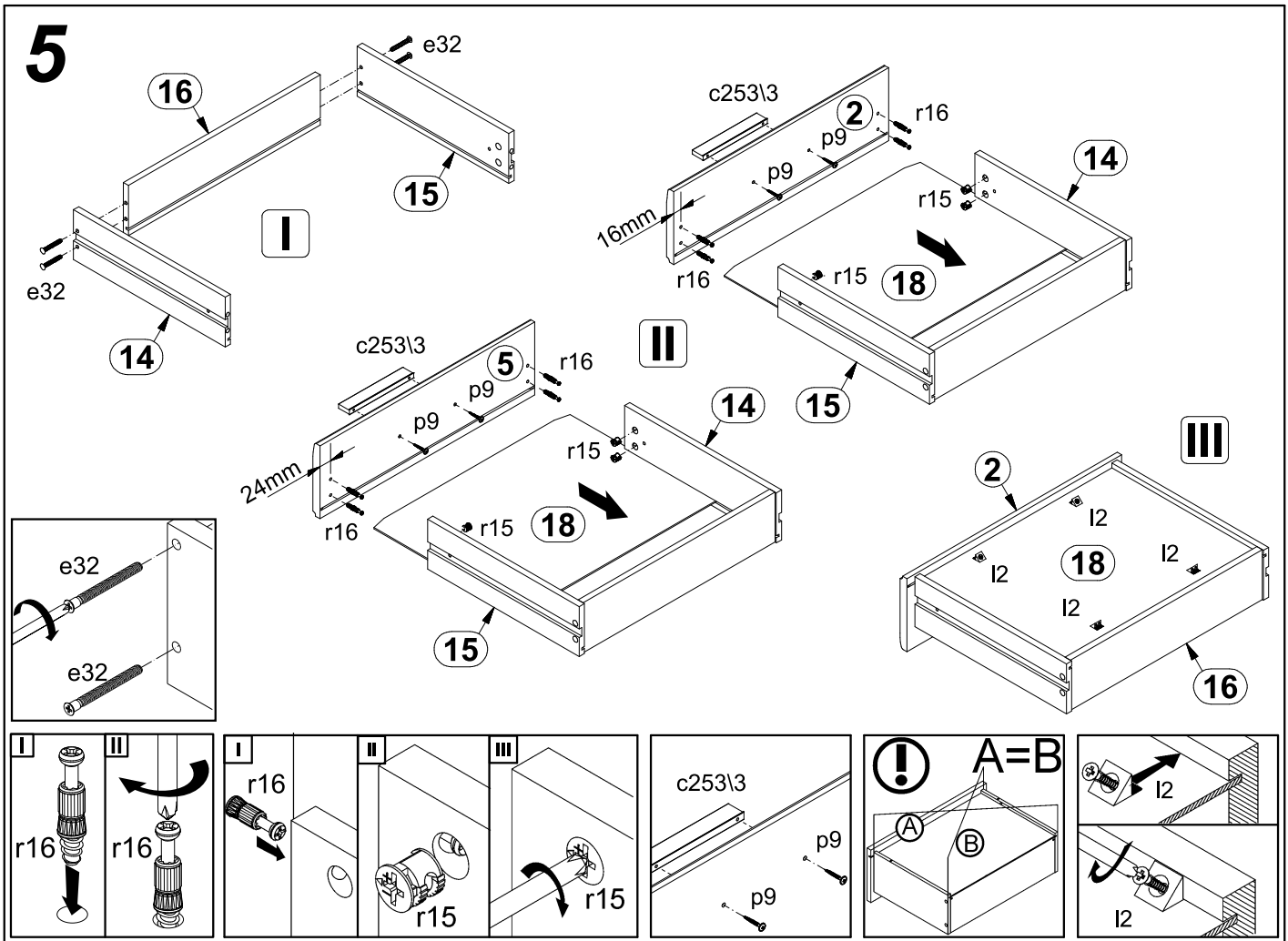
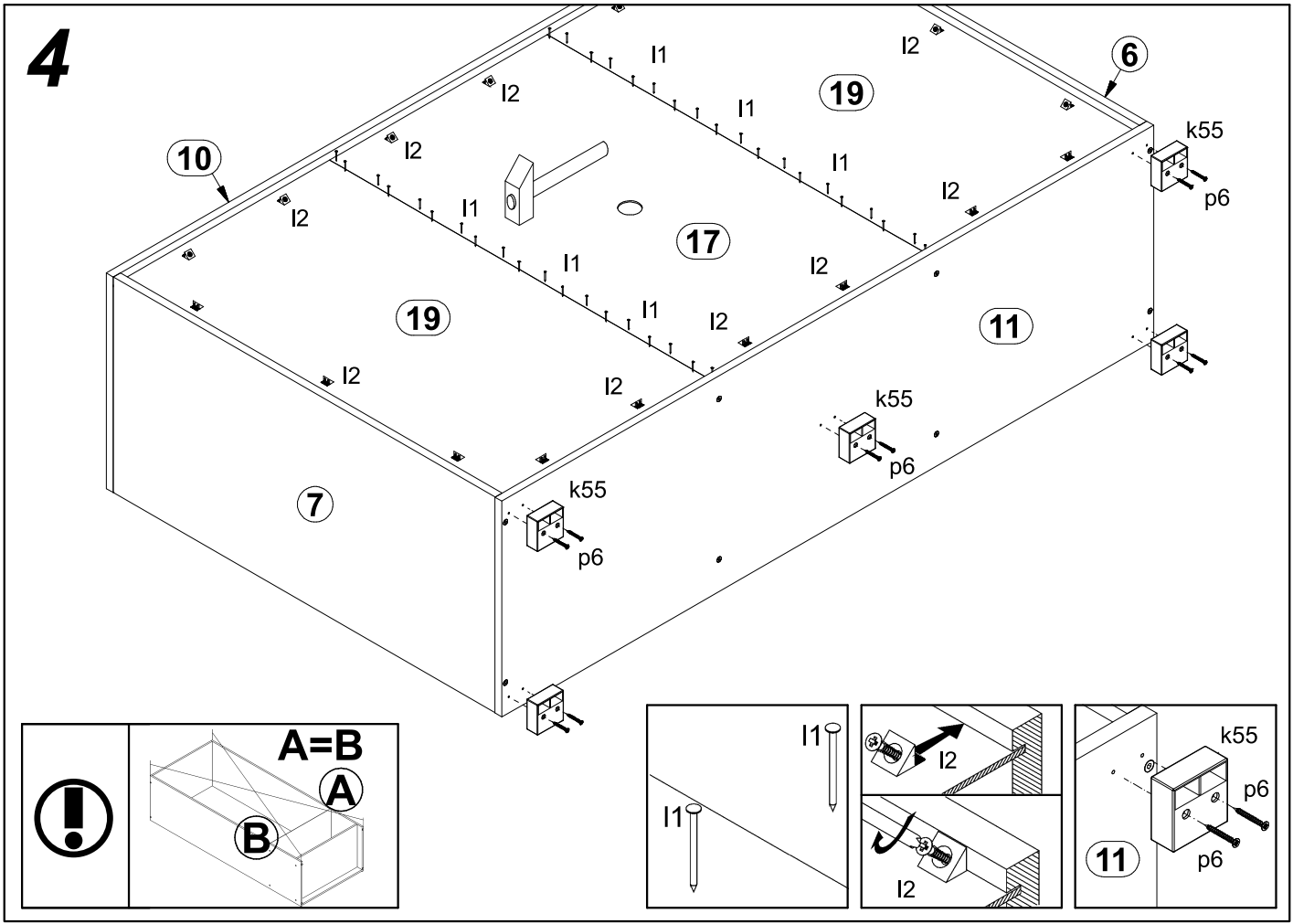

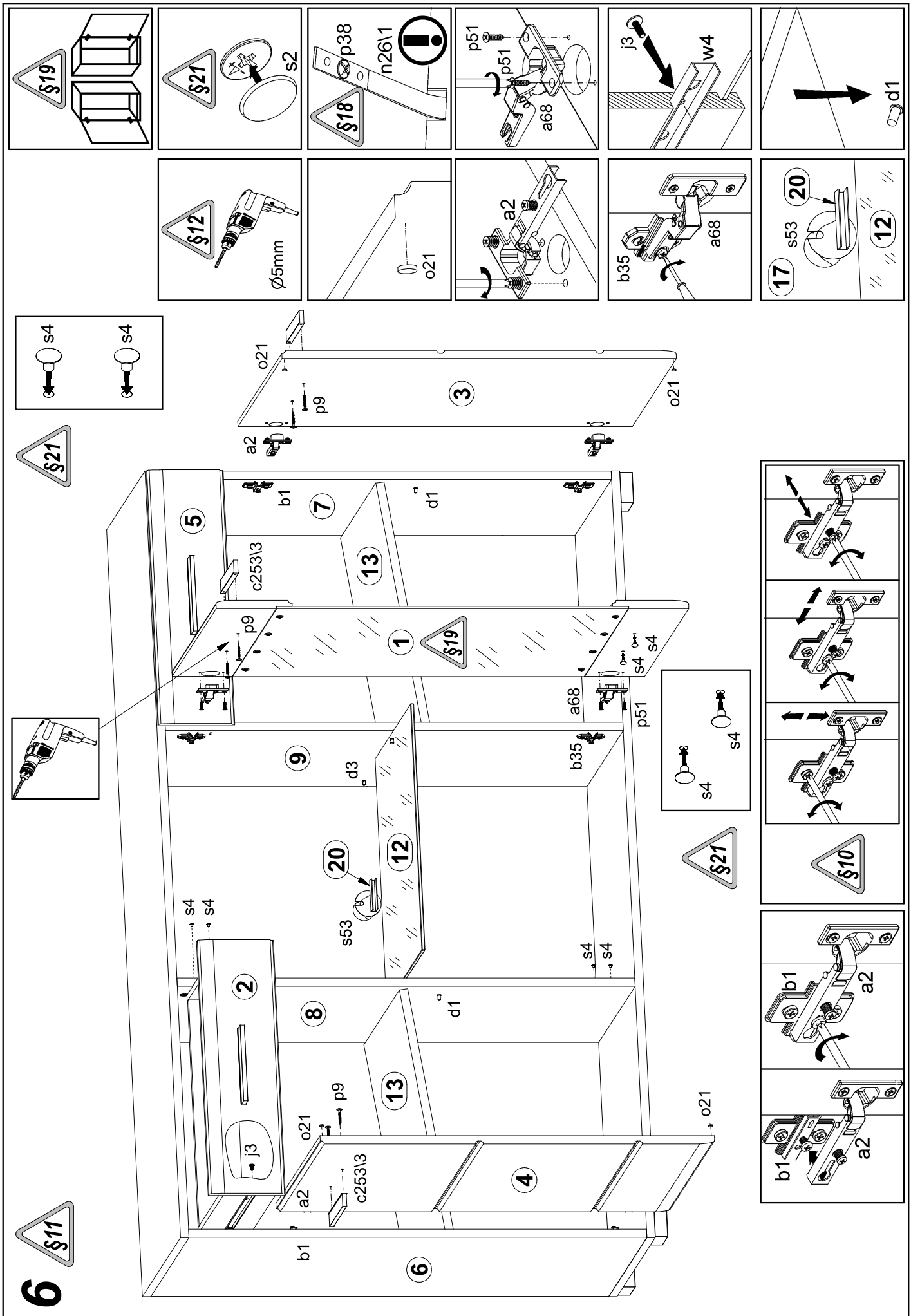

6 **S11**

S21

S4 **S4**

S19

S12

$\varnothing 5\text{mm}$

S21

S2

S18

p38

n26\1

!

S19

a2

p51

a68

p51

a68

b35

a68

j3

w4

17

S53

20

12

d1

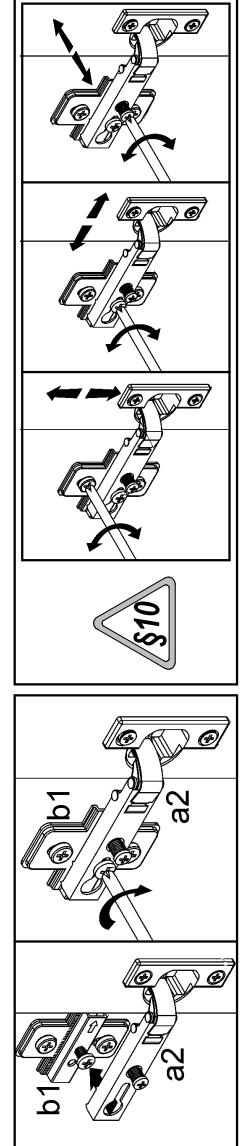

S4 **S4**

S21