

MALTA TYP 830

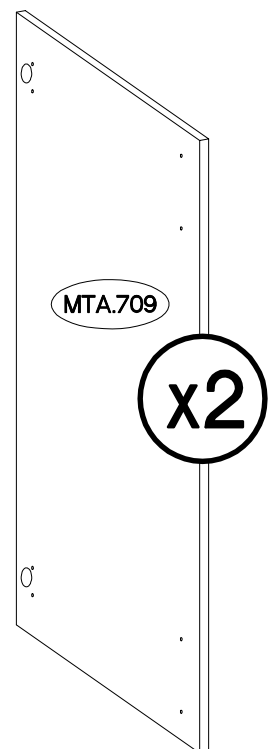

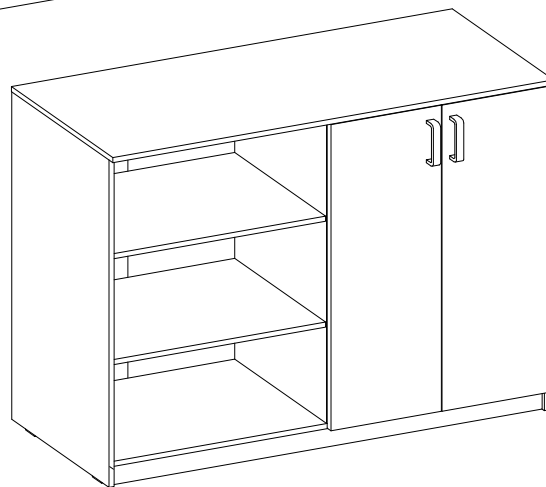
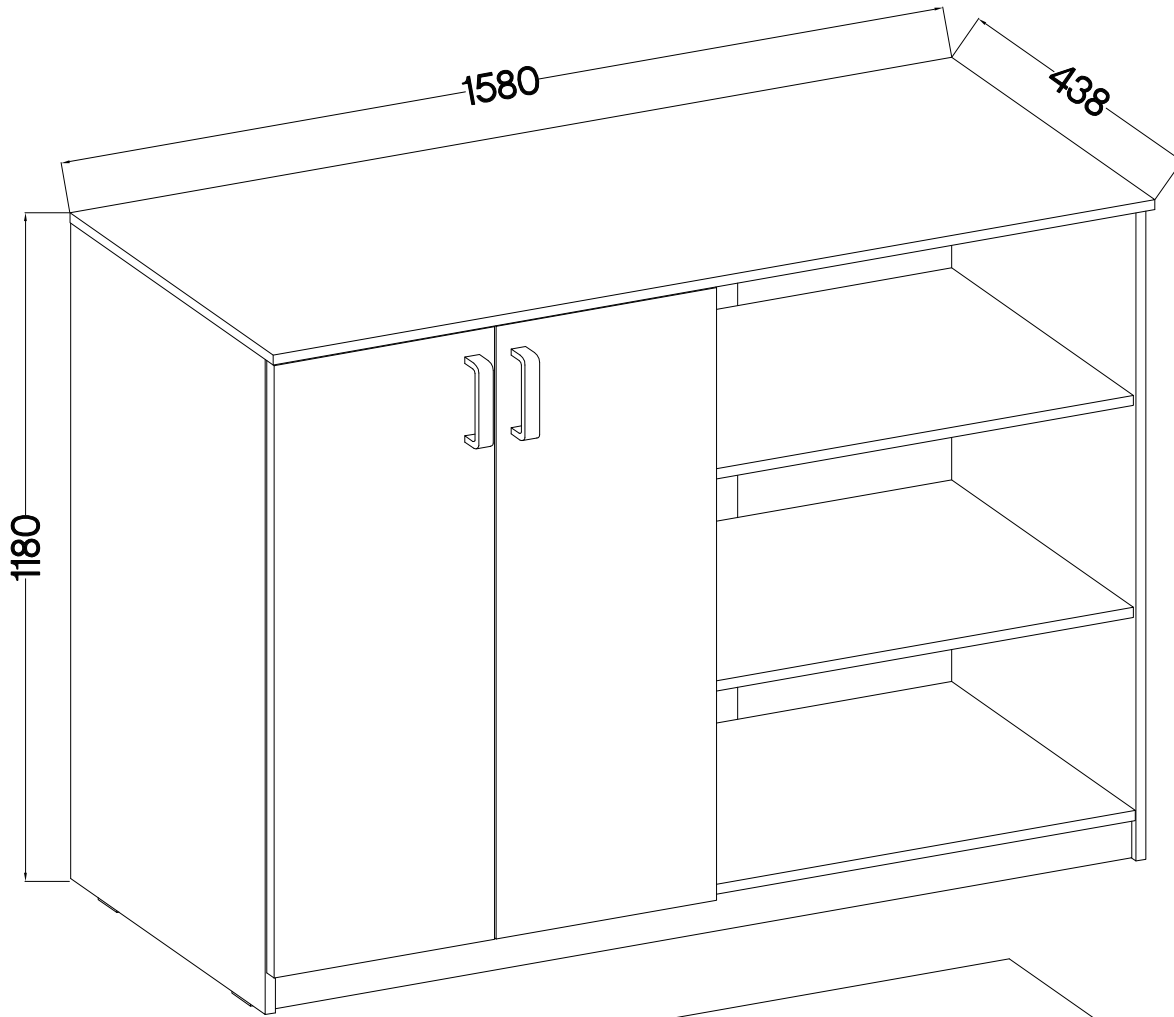
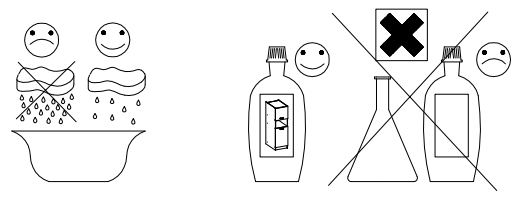

Ersatzteil Nummer	Dimension
MTA.709 x2	1081x395x16

 †35/0mm [CD] HG 4	 †3.5x13mm P5 8	 L=128mm S 2	 M4x22mm U 4
-----------------------------	--------------------------	-----------------------	-----------------------

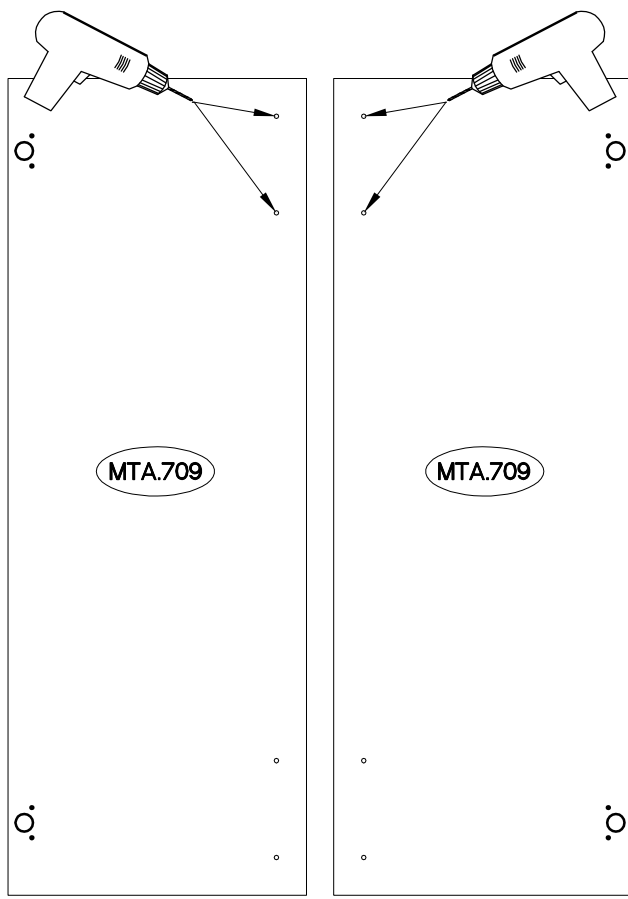
1



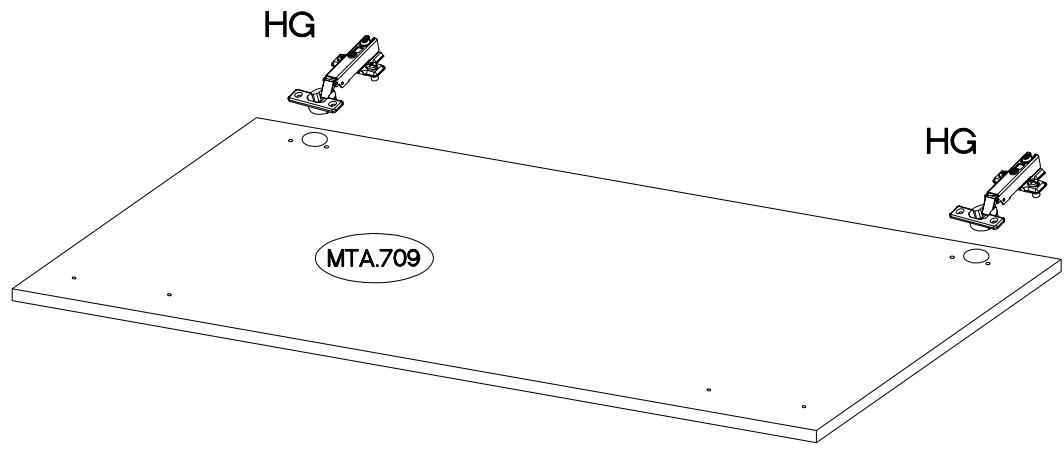
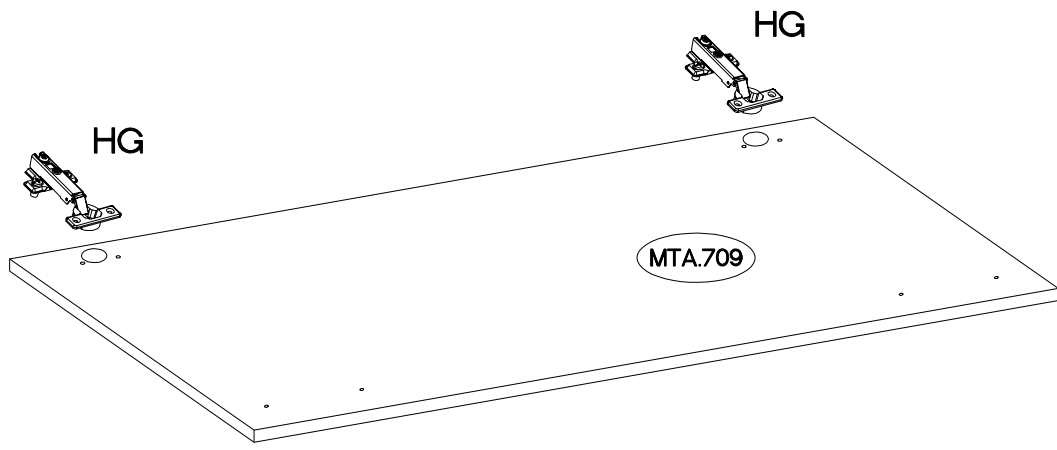
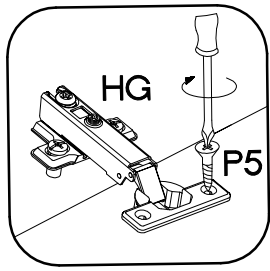
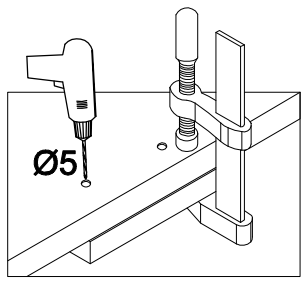
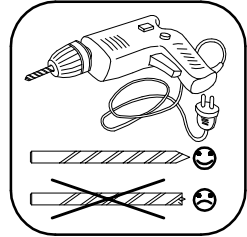

 [CD] HG 4	 P5 8
--	---



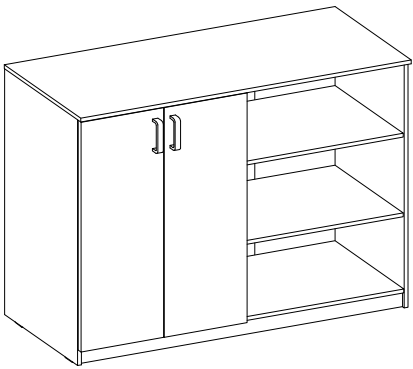

2

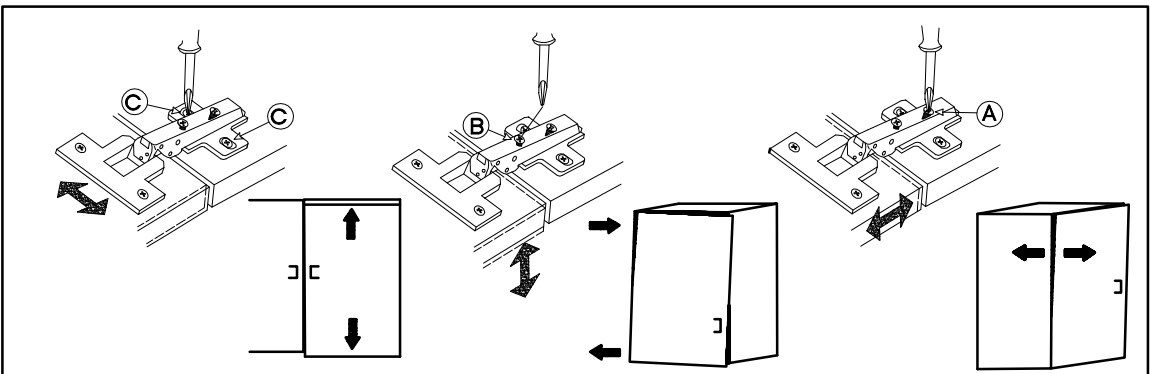
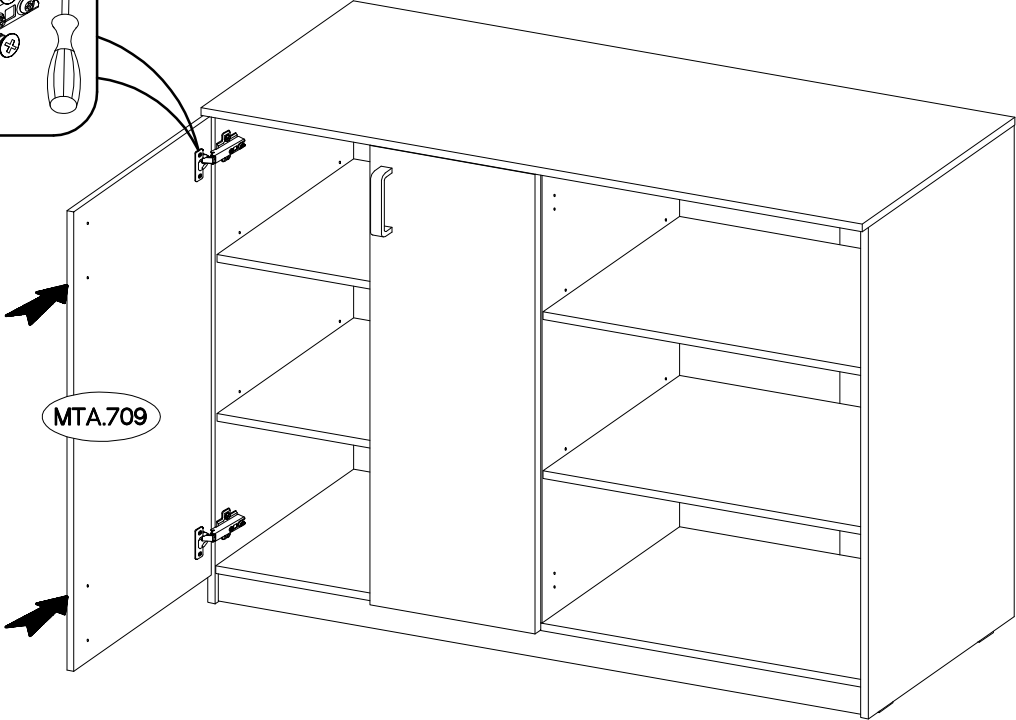
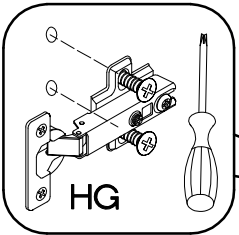
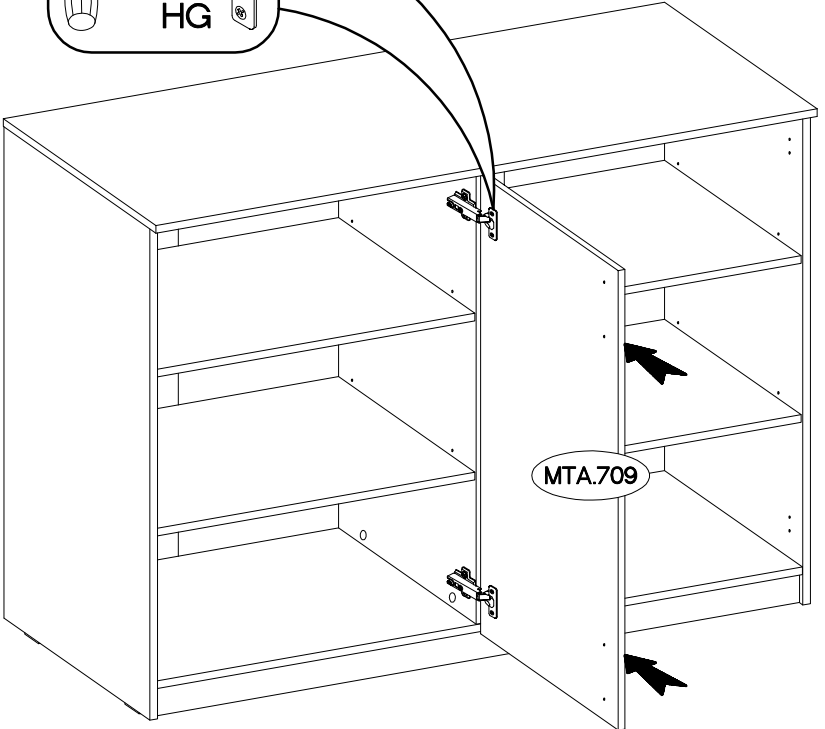
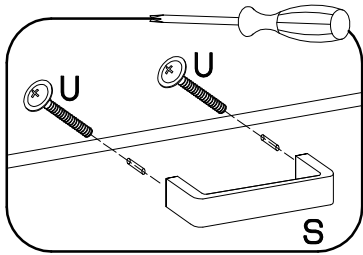
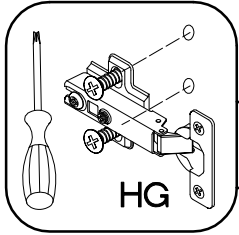

L=128mm	M4x22mm
	
S	U
2	4



3

L=128mm	M4x22mm
	
S	U
2	4

