

MALTA TYP 220

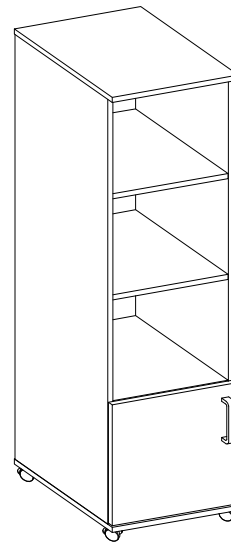

+8x30mm A 20	6,4 x 50mm B 4	+15/12mm C 20	 D2 20	 E11 20	 F19 4	 F20 4	 [CD] HG 2	 J3 4	 O 1	 P5 4	 R11 16	 S 1	 U 2
-------------------------------	---------------------------------	--------------------------------	---------------------	----------------------	---------------------	---------------------	-------------------------	--------------------	-------------------	--------------------	----------------------	-------------------	-------------------

Ersatzteil Nummer	Dimension
MTA.121	1500x400x18
MTA.122	1500x400x18
MTA.213	452x422x18
MTA.214	452x422x18
MTA.305	413x365x18
MTA.407 x3	414x398x18
MTA.712	427x445x16
MTA.910	414x414x18

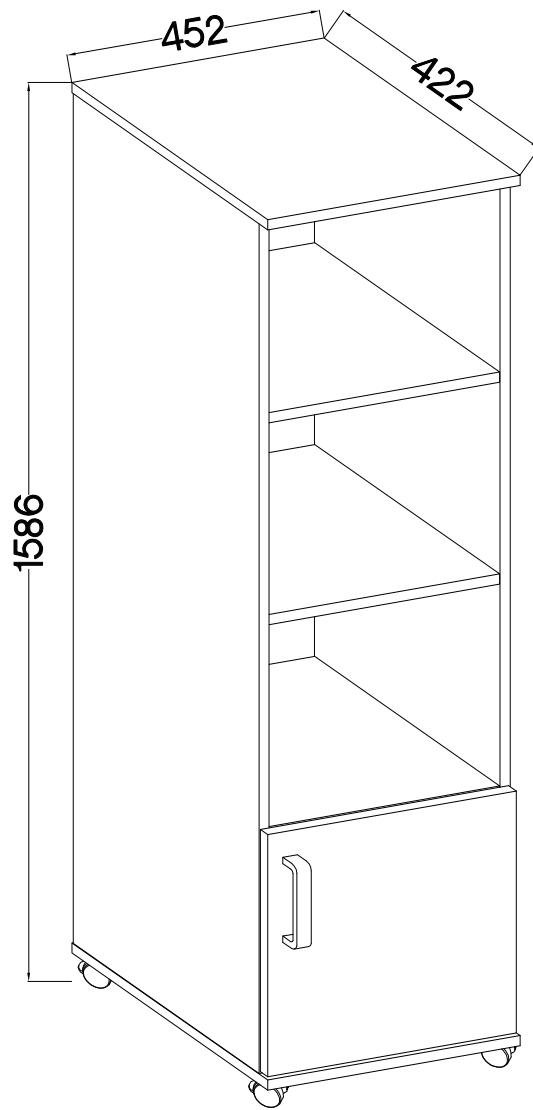
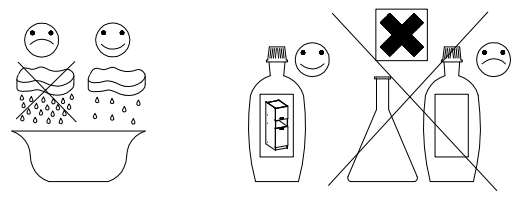

MTA.305

MTA.407

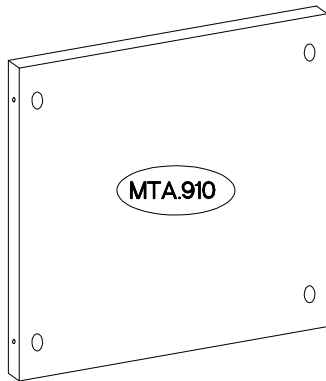

MTA.910

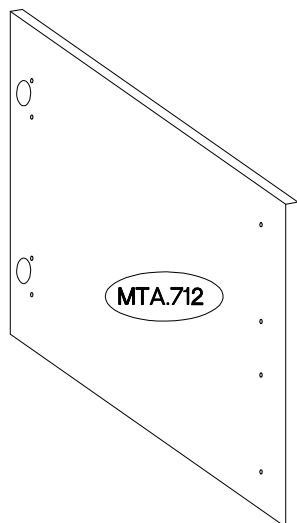

MTA.712

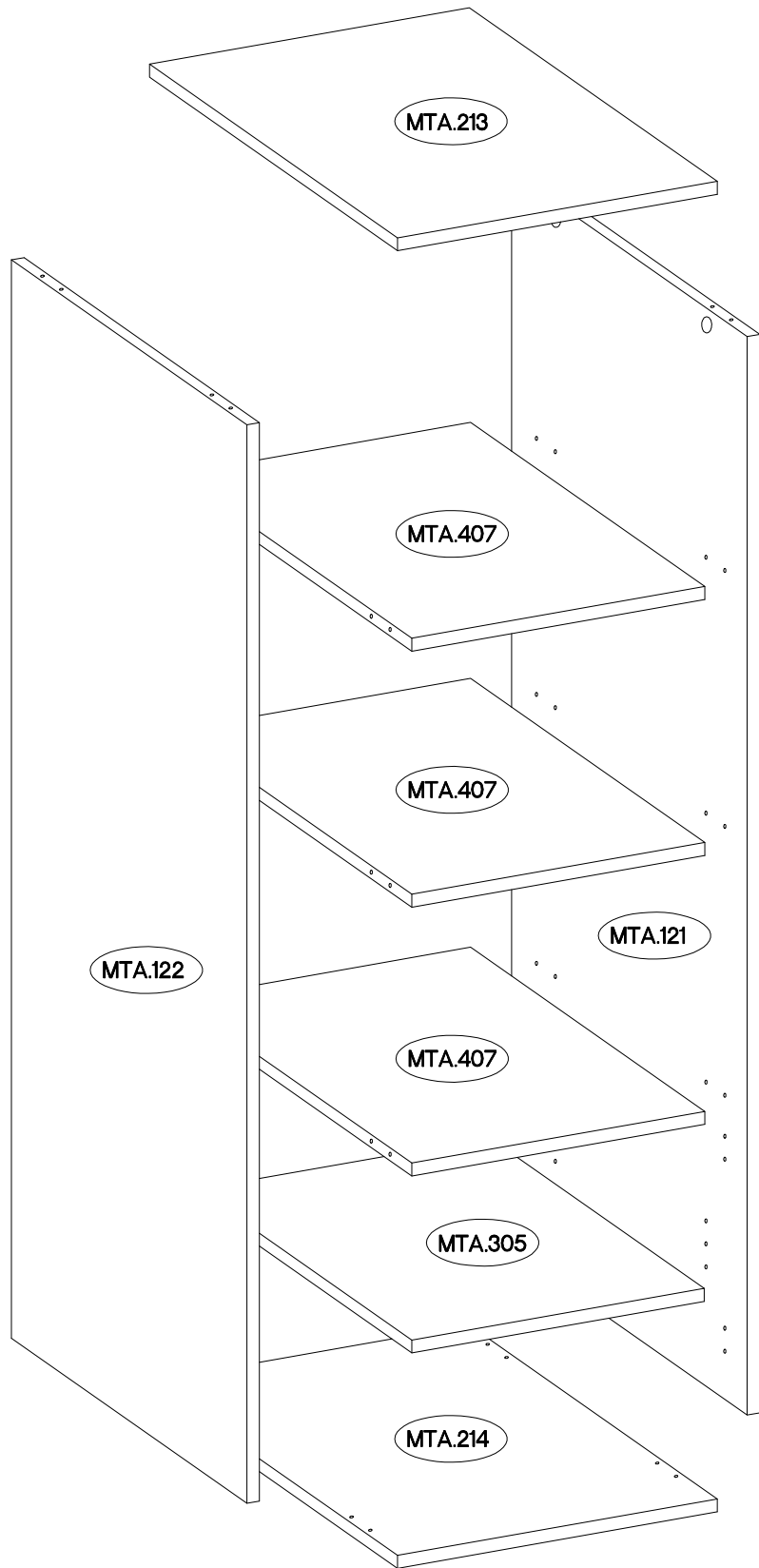

MTA.213

MTA.407

MTA.407

MTA.407



MTA.305

MTA.214

MTA.122

MTA.121

1

$\varnothing 8 \times 30 \text{mm}$  A	L=20mm  D2	$\varnothing 15/12 \text{mm}$  C
20	20	20

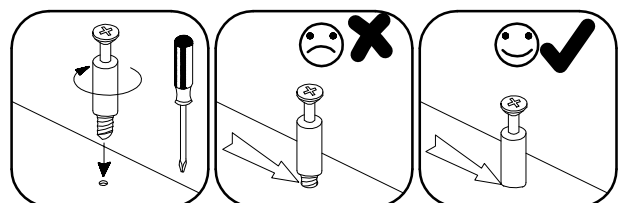
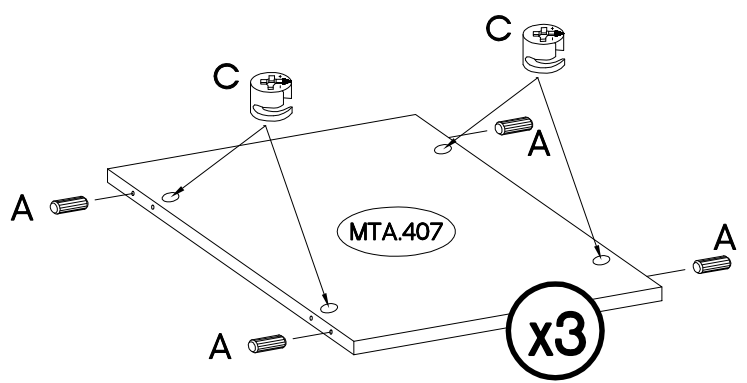
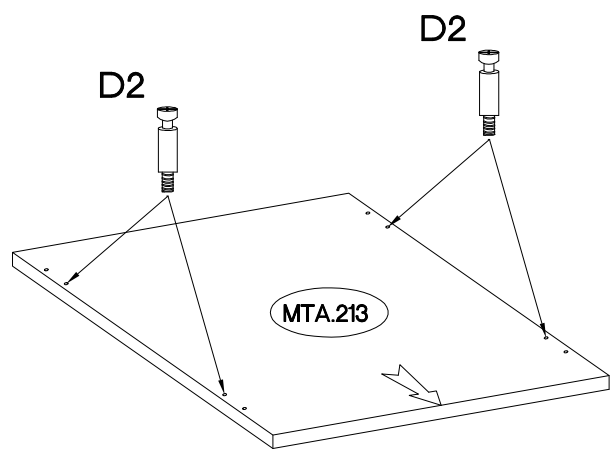
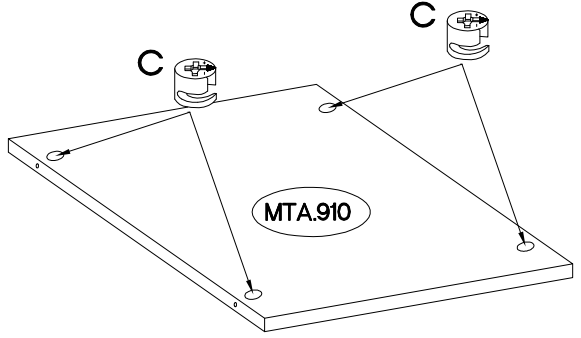
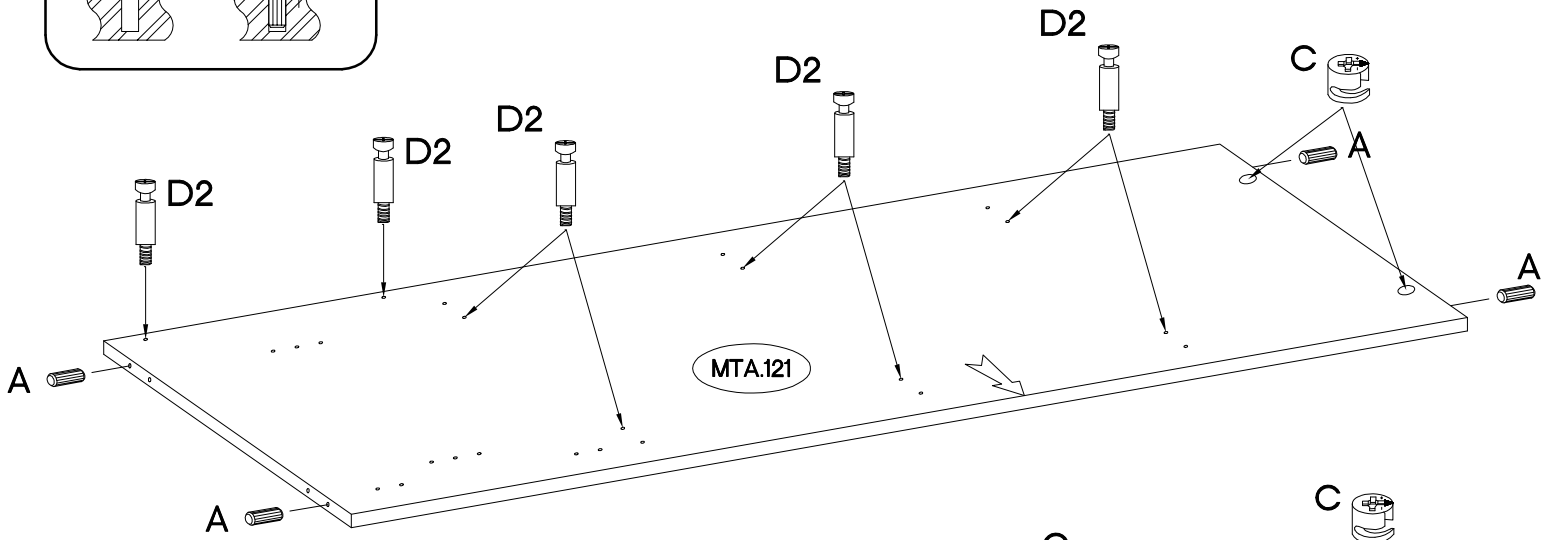
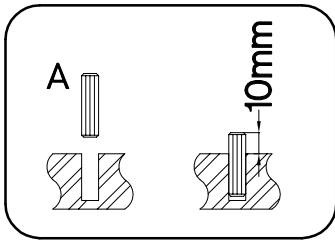
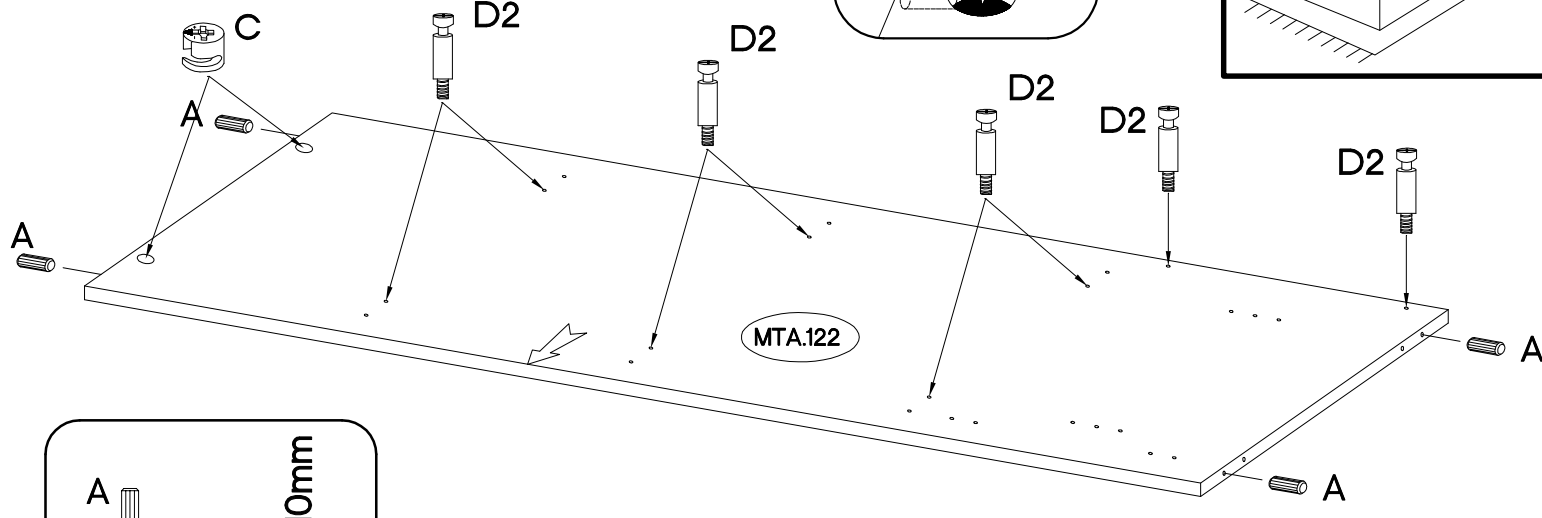
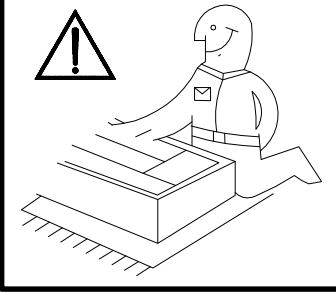
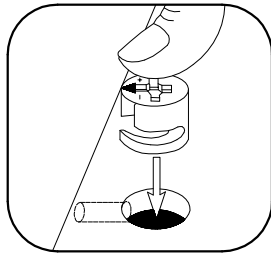

2

±4.0x16mm



R11

16

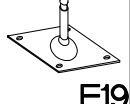

F19

4



F20

4

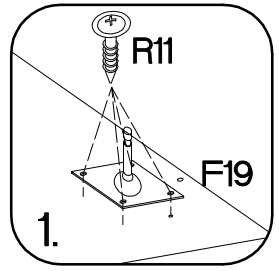
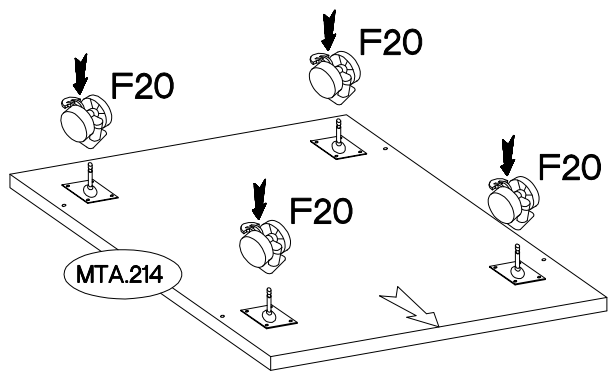
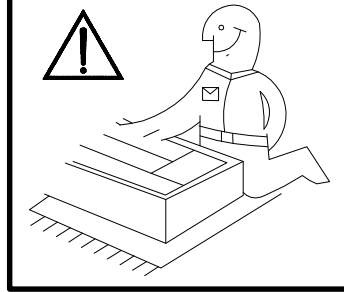

1.

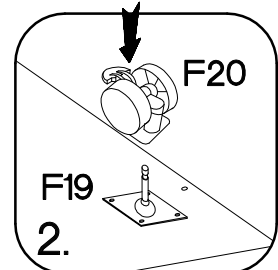

2.

3

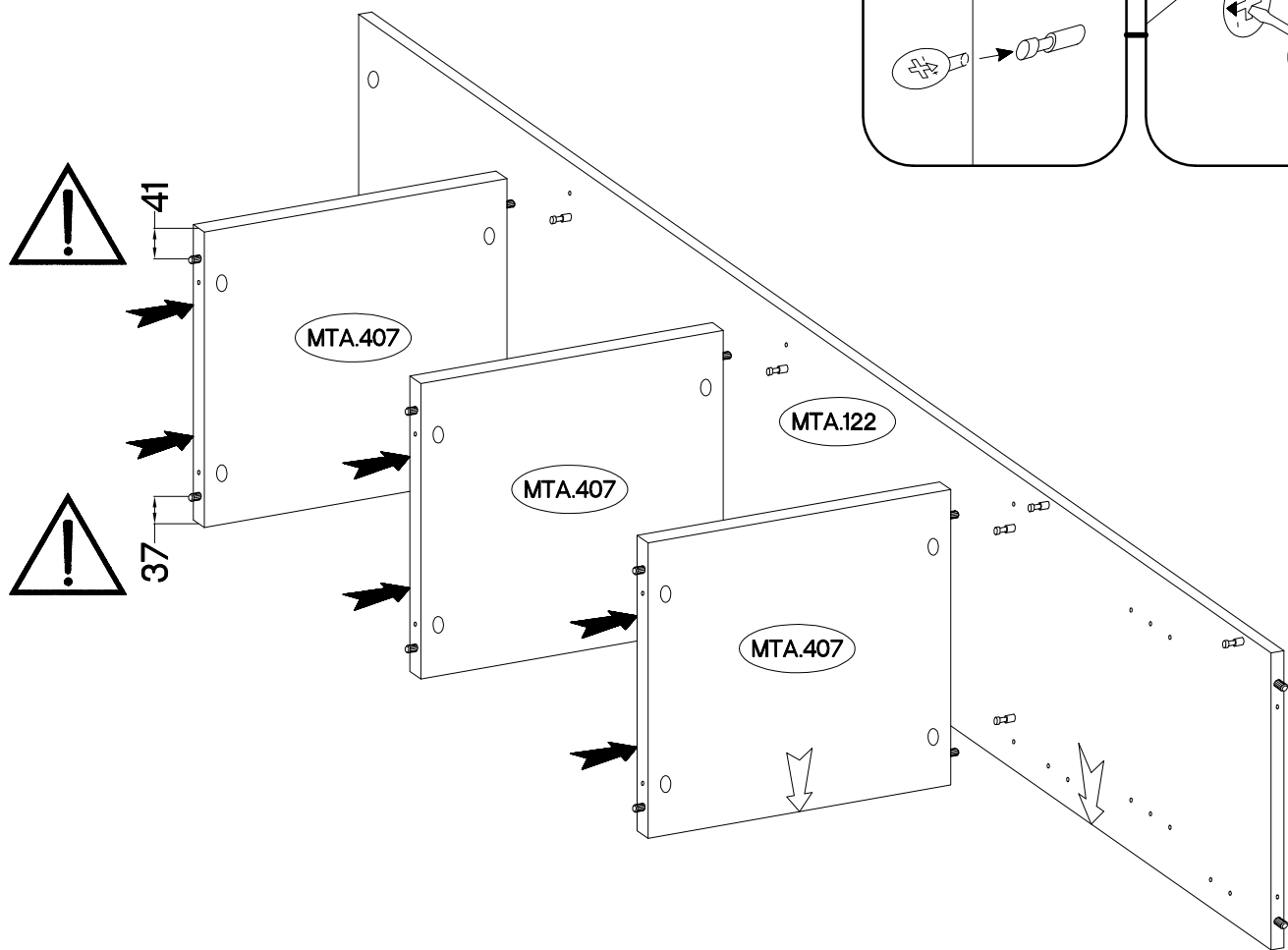
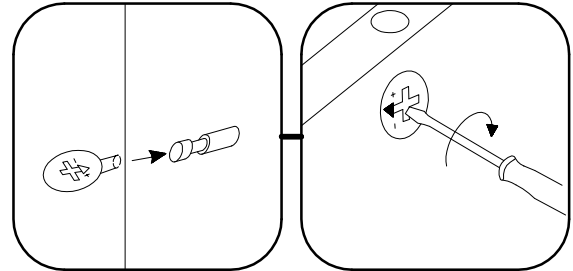

4

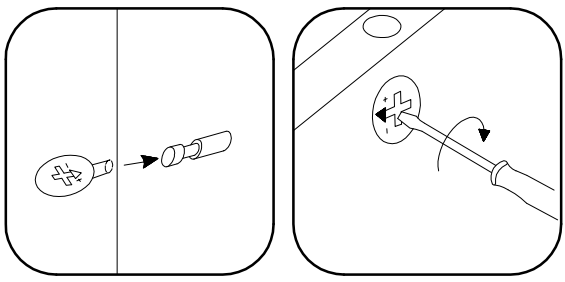
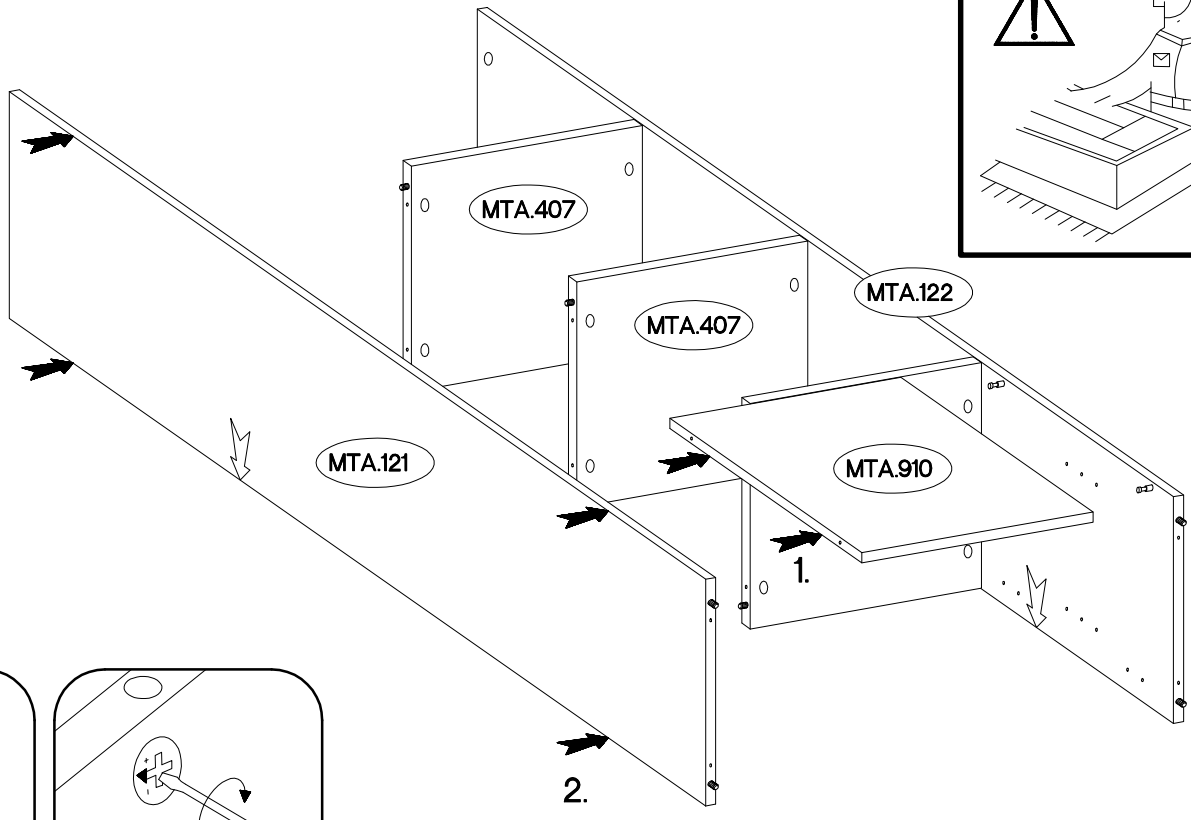
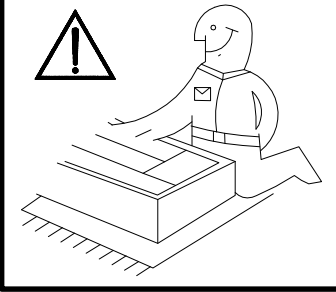

5

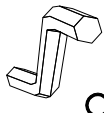
6,4 x 50mm	
	
B	O
4	1

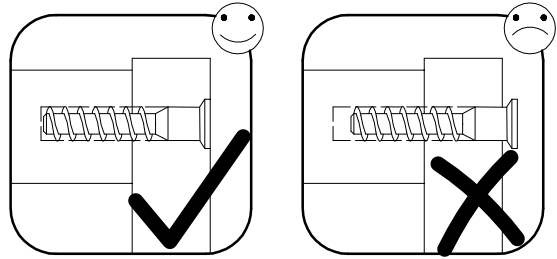
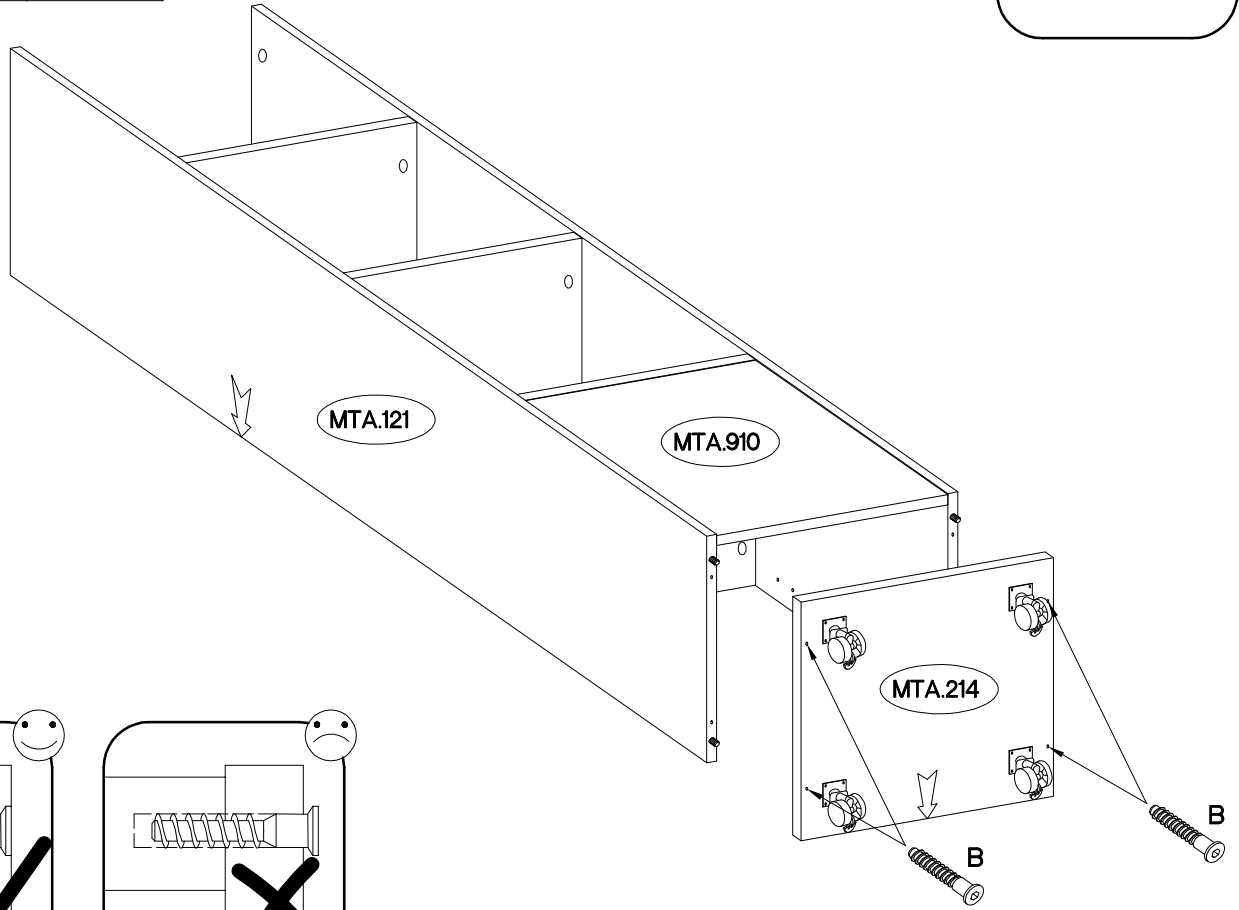
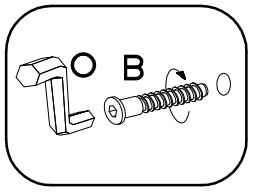

6

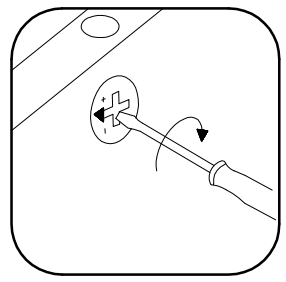
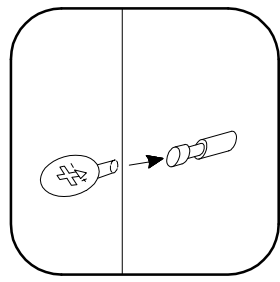
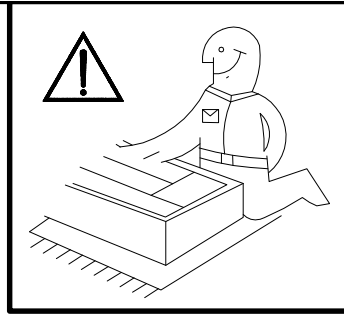
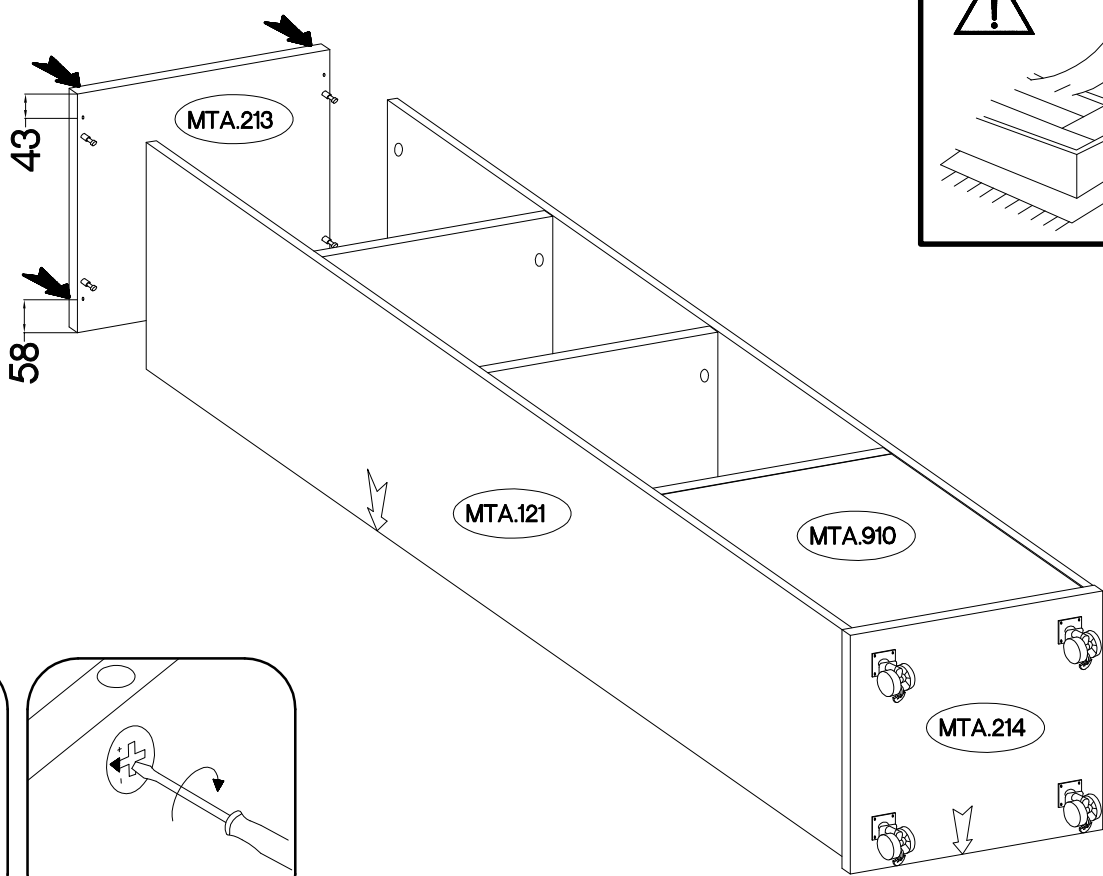

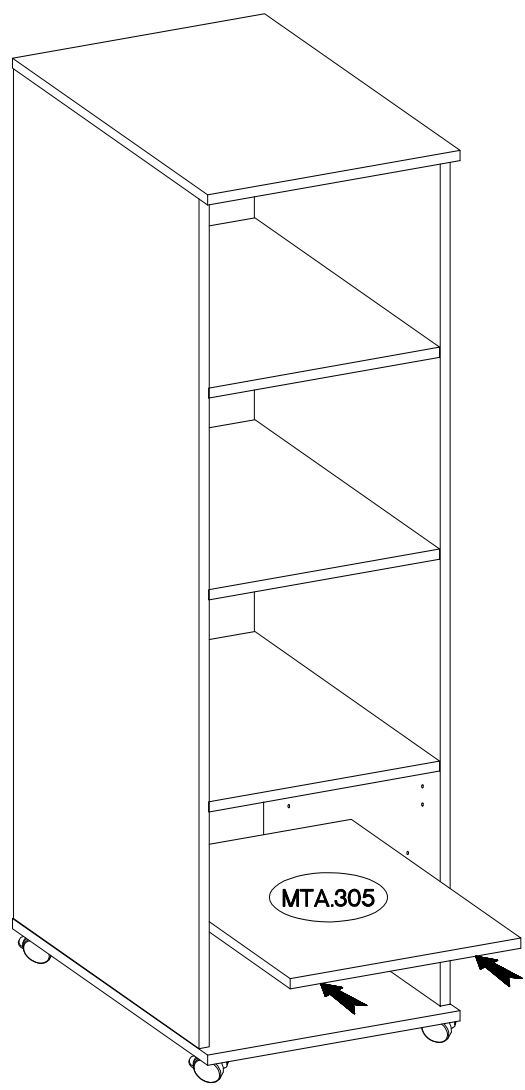

7

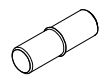
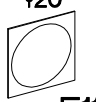

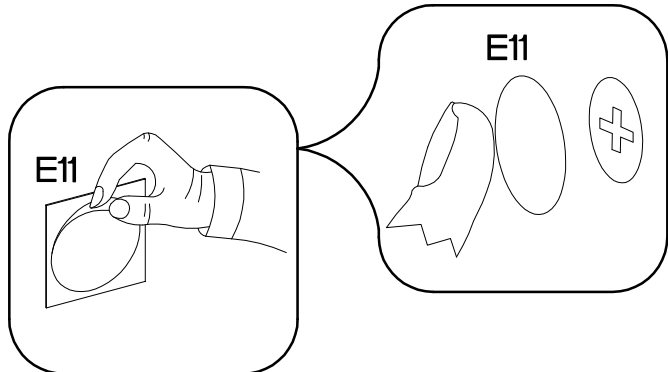
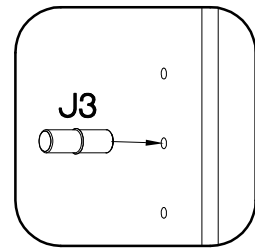

±5/16mm  J3 4	±20  E11 20
---	---

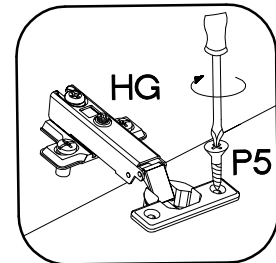
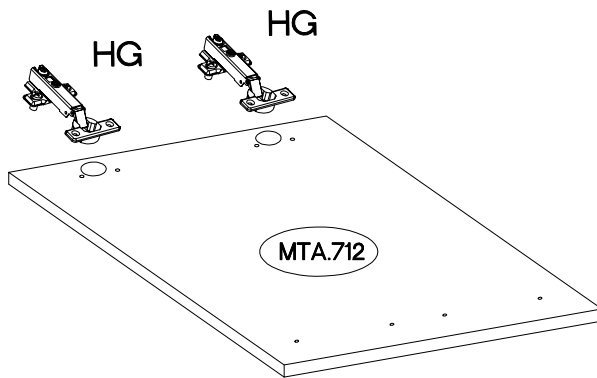
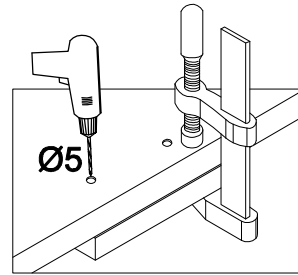
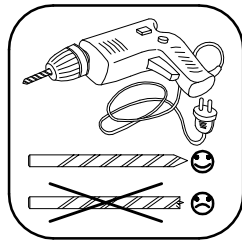
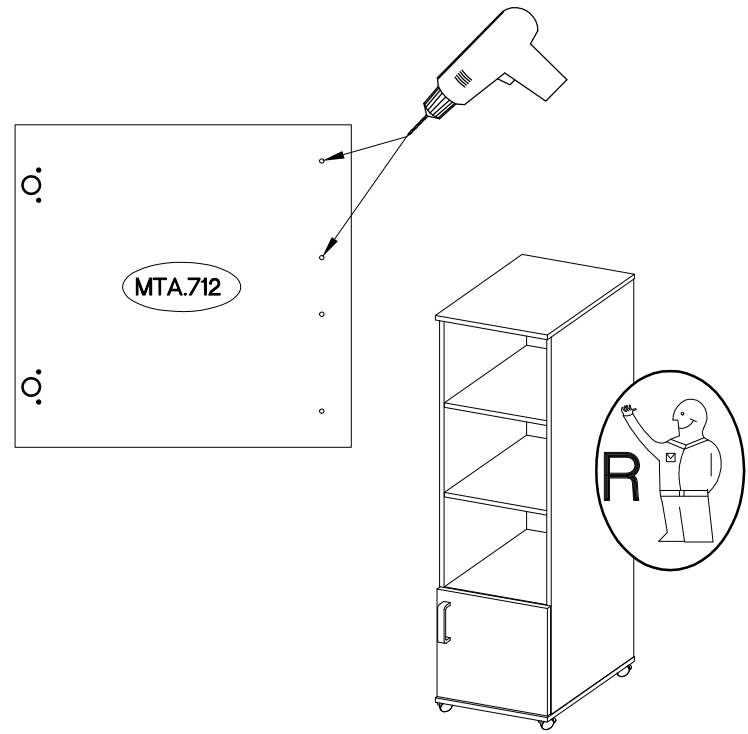
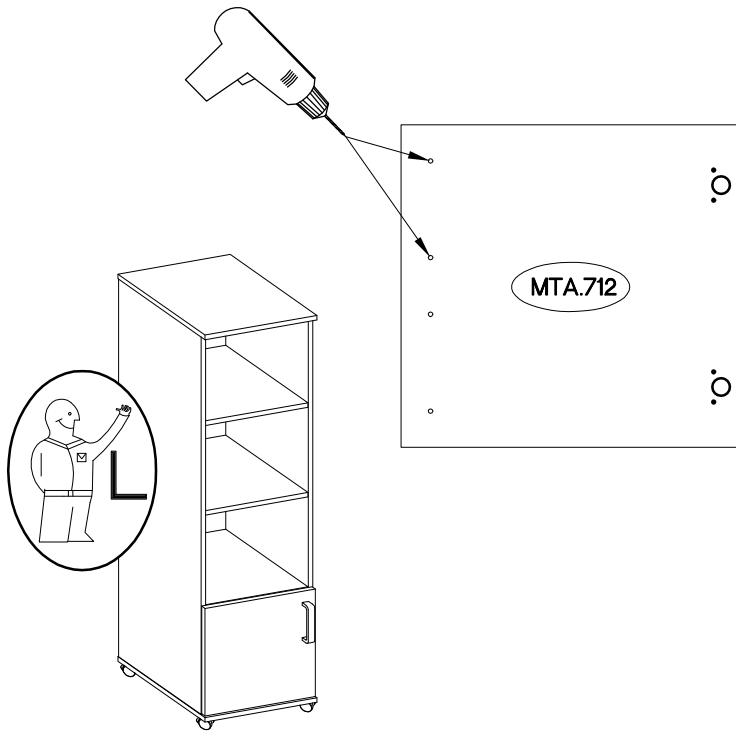

$\pm 35/0\text{mm}$  [CD] HG 2	$\pm 3.5 \times 13\text{mm}$  P5 4
---	---



9

L=128mm	M4x22mm
	
S	U
1	2

