

MALTA

6X--MA80

Type:02

1 / 13

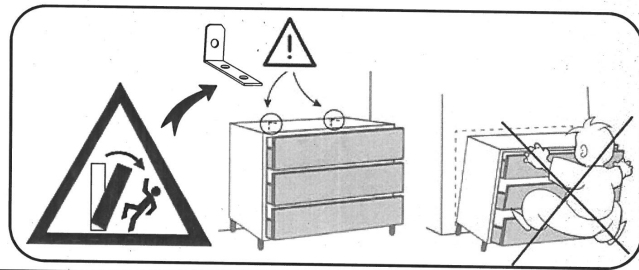
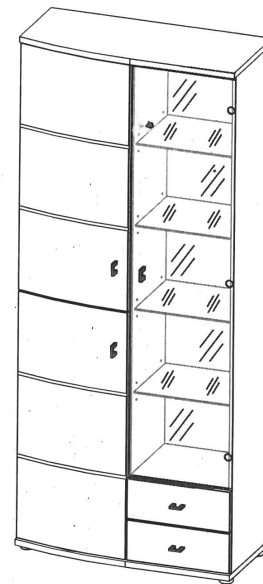
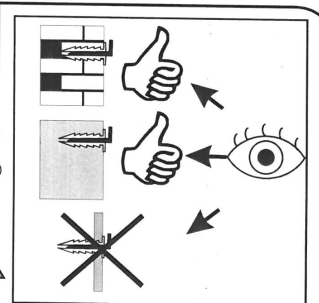
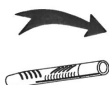
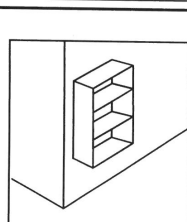
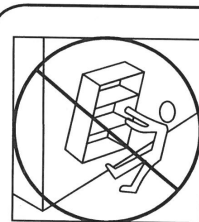
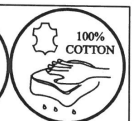
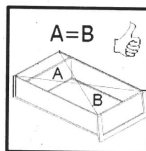
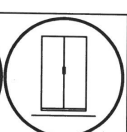
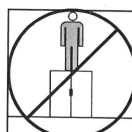
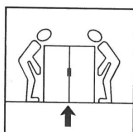
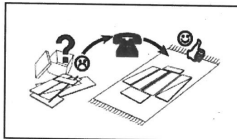
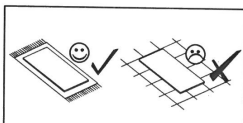
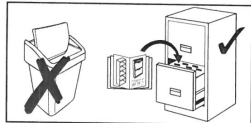
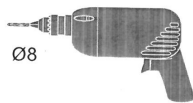
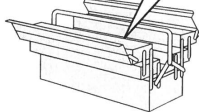
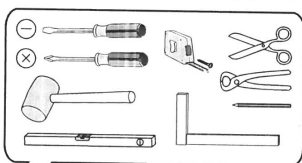
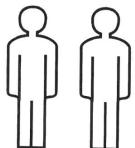

# MALTA

# 6X--MA80

# Type:02

# 2 / 13

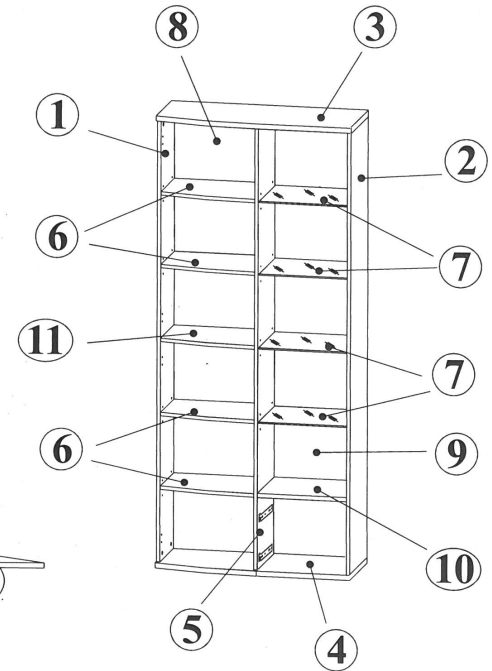
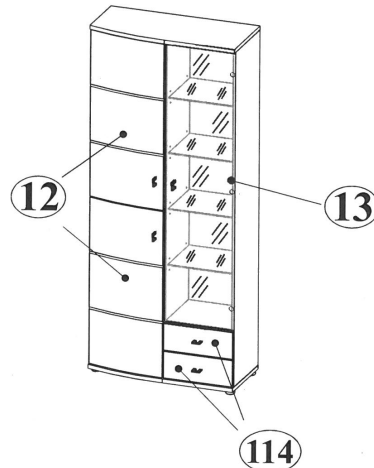
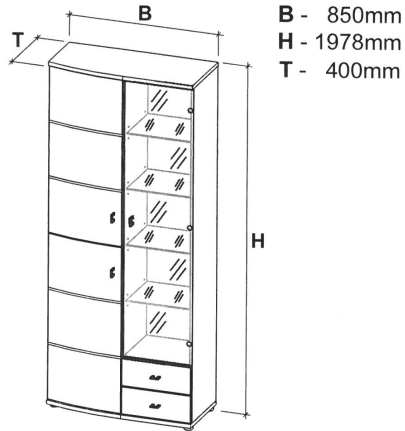

1	1909x305	1	2/2
2	1909x375	1	2/2
3	850x400	1	1/2
4	850x400	1	1/2
5	1909x355	1	2/2
6	426x354	4	1/2
7	375x330	4	1/2
8	1918x438	1	2/2
9	1918x388	1	2/2
10	376,5x354	1	1/2
11	426,5x354	1	1/2
12	452x950	2	2/2
13	1583x396	1	2/2
114	396x156	2	2/2
115L, 115R	352x100	4	1/2
15	327,5x100	2	1/2
16	337x350	2	1/2

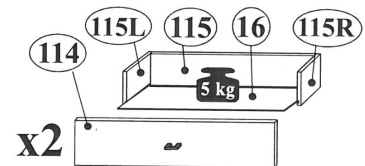
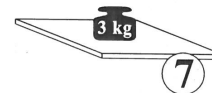
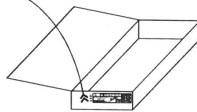

## NR 1

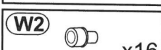
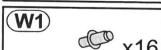
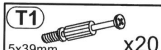
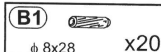

## NR 2

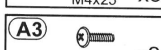
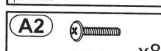
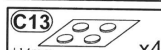
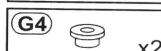

## NR 3

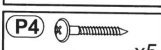

## NR 4

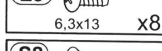

## NR 5



## NR 6



## NR 7

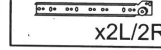
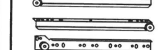
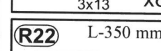
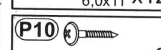
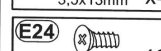

BELEUCHTUNG FÜR  
TYPE 02 UND 04

Oświetlenie do  
typu 02 i 04

C 1/2



PL- Produkty te zawierają źródła światła, które ze względu na swoje właściwości nie podlegają rozporządzeniu (UE) 2019/2015

DA- Disse produkter indeholder lyskilder, som på grund af deres egenskaber er uden for anvendelsesområdet for forordning (EU) 2019/2015

ES- Estos productos contienen fuentes de luz que, por sus propiedades, quedan fuera del ámbito de aplicación del Reglamento (UE) 2019/2015.

FR- Ces produits contiennent des sources lumineuses qui, en raison de leurs propriétés, n'entrent pas dans le champ d'application du règlement (UE) 2019/2015

LT- Šiuose gaminių yra šviesos šaltiniai, kurie dėl savo savybių nepatenka į Reglamento (UE) 2019/2015 taikymo sritį

PT- Estes produtos contêm fontes de luz que, devido às suas propriedades, estão fora do âmbito do Regulamento (UE) 2019/2015

SK- Tieto výrobky obsahujú svetelné zdroje, ktoré vzhľadom na svoje vlastnosti nepatria do rozsahu pôsobnosti nariadenia (EÚ) 2019/2015

TR- Bu ürünler, özellikleri nedeniyle (UE) 2019/2015 Yürürlükte bulunan kapsama dışındaki kalen için kaynaqları içerir.

DE- Diese Produkte enthalten Lichtquellen, die aufgrund ihrer Eigenschaften nicht unter die Verordnung (EU) 2019/2015 fallen

EL- Αυτά τα προϊόντα περιλαμβάνουν πηγές φωτός οι οποίες, λόγω των ιδιοτήτων τους, δεν εμπίπτουν στο πεδίο εφαρμογής του κανονισμού (UE) 2019/2015

ET- Need tooted sisaldivad valgusallikaid, mis oma omaduste tõttu jäävad väljale määruse (UE) 2019/2015 reguleerimisalast välja

HU- Ezek a termékek olyan fényforrásokat tartalmaznak, amelyek tulajdonságuk miatt nem tartoznak az (EU) 2019/2015 rendelet hatálya alá

LV- Šie produkti satur gaismas avotus, kas to īpašību dēļ ir ārpus Regulas (Ei) 2019/2015 darbības jomas

RO- Aceste produse conțin surse de lumină care, datorită proprietăților lor, nu intră în domeniul de aplicare al Regulamentului (UE) 2019/2015

SI- Ti izdelki vsebujejo svetlobne vire, ki zaradi svojih lastnosti ne spadajo na področje uporabe Uredbe (EU) 2019/2015

HR- Ovi proizvodi sadrže izvore svjetlosti koji zbog svojih svojstava nisu obuhvaćeni Uredbom (EU) 2019/2015

CS- Tyto výrobky obsahují světelné zdroje, které vzhledem ke svým vlastnostem nespadají do oblasti působnosti nařízení (EU) 2019/2015

EN- These products contain light sources which, due to their properties, are out of the scope of Regulation (EU) 2019/2015

FI- Nämä tuotteet sisältävät valonlähteitä, jotka ominaisuuksiensa vuoksi eivät kuulu asetuksen (EU) 2019/2015 soveltamisalaan

IT- Questi prodotti contengono sorgenti luminose che, per le loro proprietà, esulano dal campo di applicazione del Regolamento (UE) 2019/2015

RU- Эти продукты содержат источники света, которые из-за своих свойств не подпадают под действие Регламента (ЕУ) 2019/2015.

NL- Deze producten bevatten lichtbronnen die vanwege hun eigenschappen buiten het toepassingsgebied van Verordening (EU) 2019/2015 vallen

SV- Dessa produkter innehåller ljuskällor som på grund av sina egenskaper inte omfattas av förordning (EU) 2019/2015

BG- Тези продукти съдържат източници на светлина, които поради своите свойства са извън обхвата на Регламент (ЕО) 2019/2015

# MALTA

# 6X--MA80

# Type:02

# 4 / 13

# 1

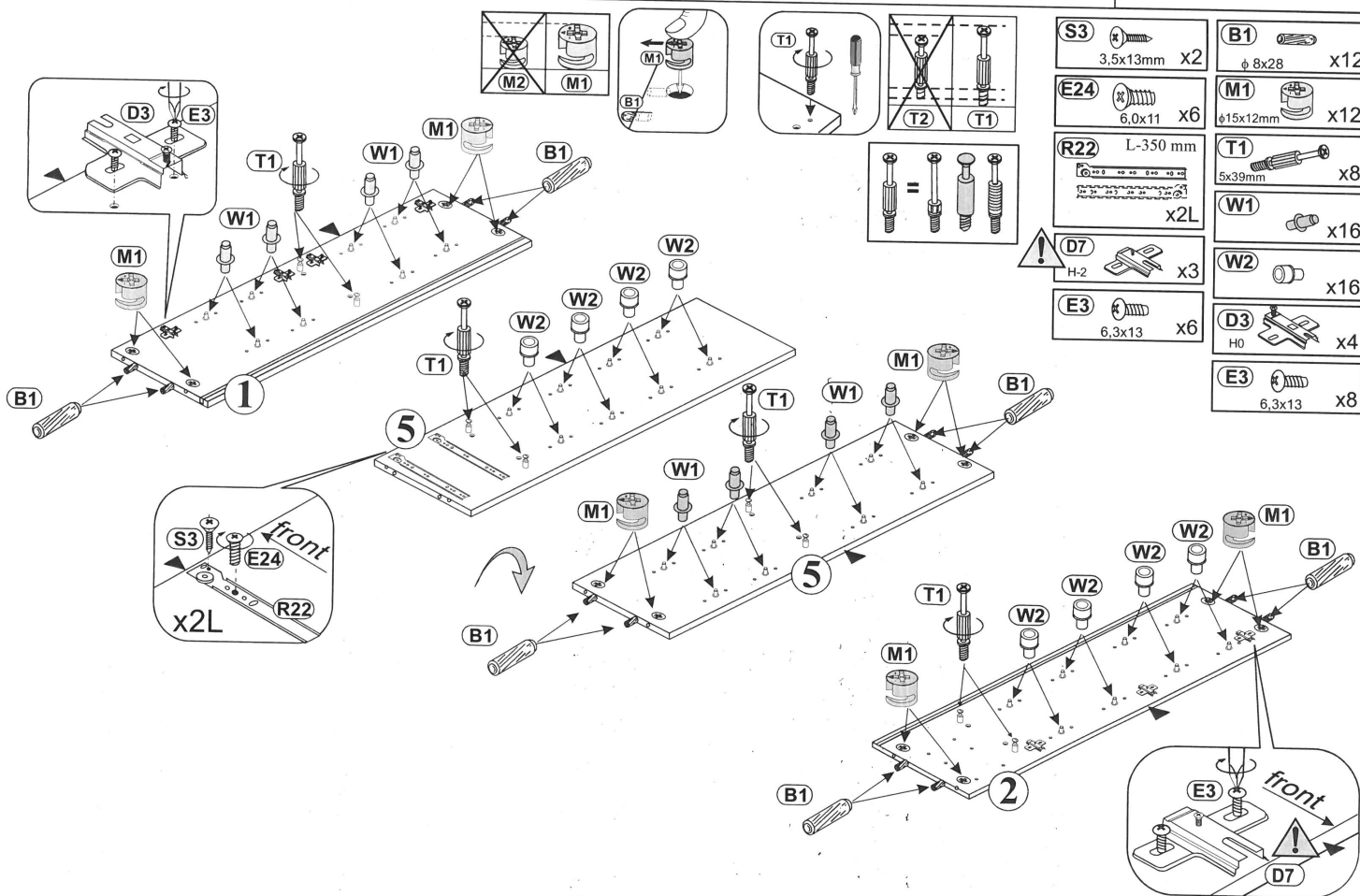

# MALTA

# 6X--MA80

# Type:02

# 5 / 13

## 2

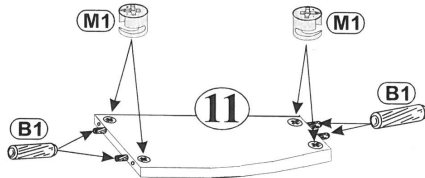
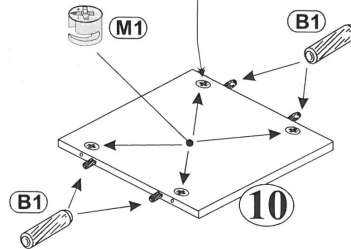
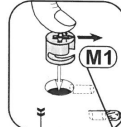
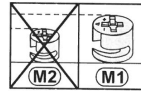
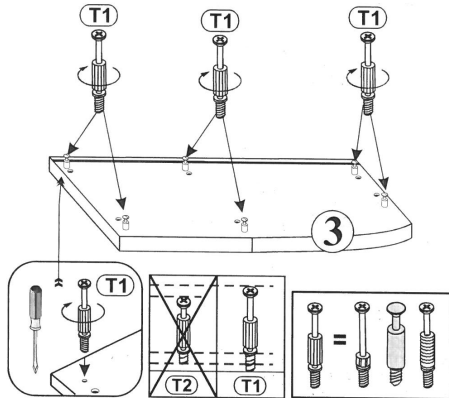
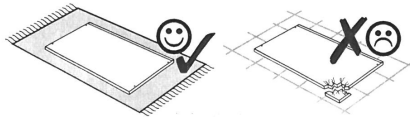

## 3

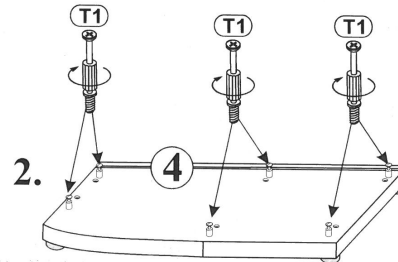
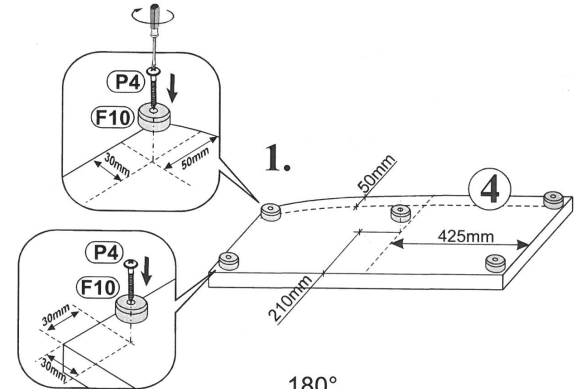
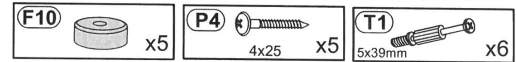

4

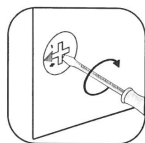
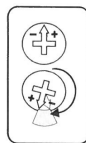
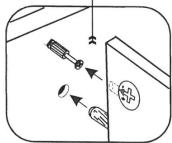
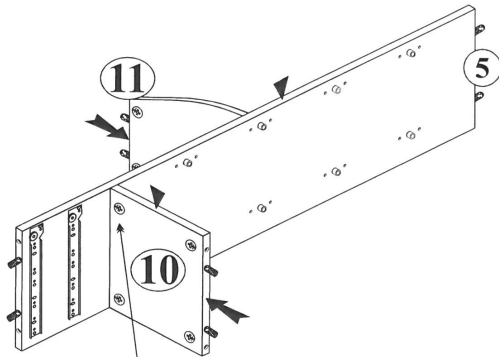

5

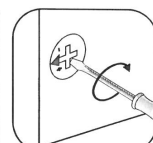
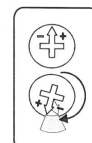
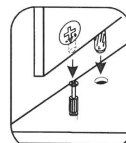
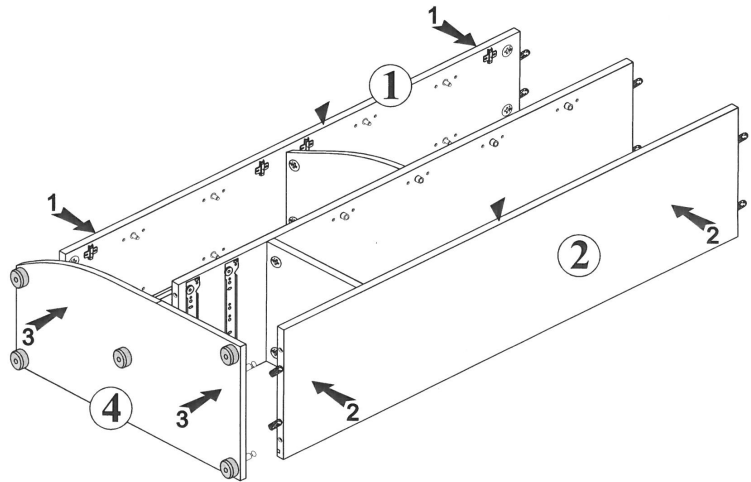



# MALTA

# 6X--MA80

# Type:02

# 8 / 13

## 8

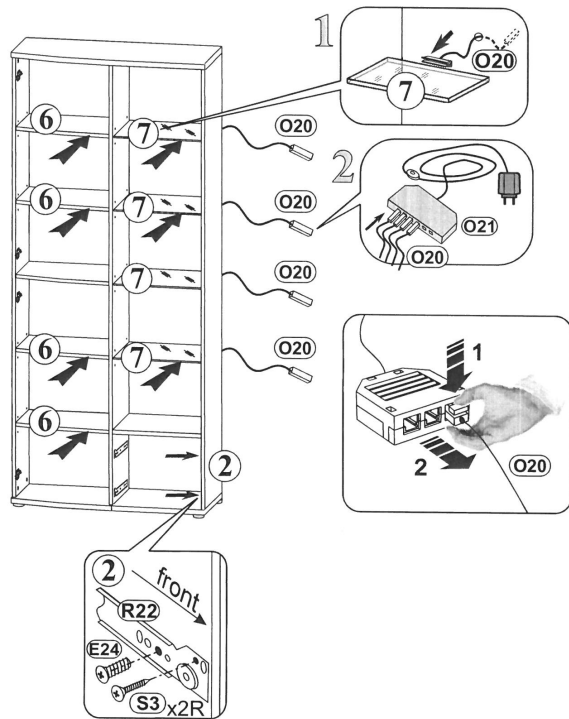
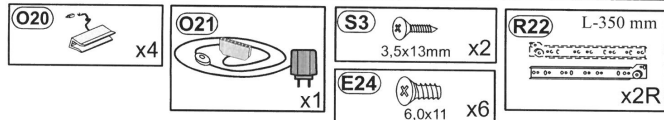

## 9

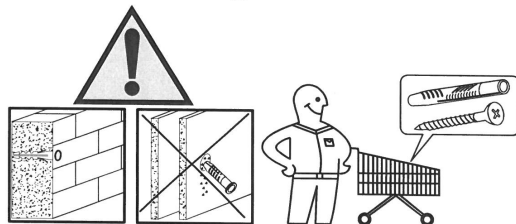
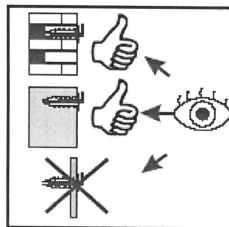
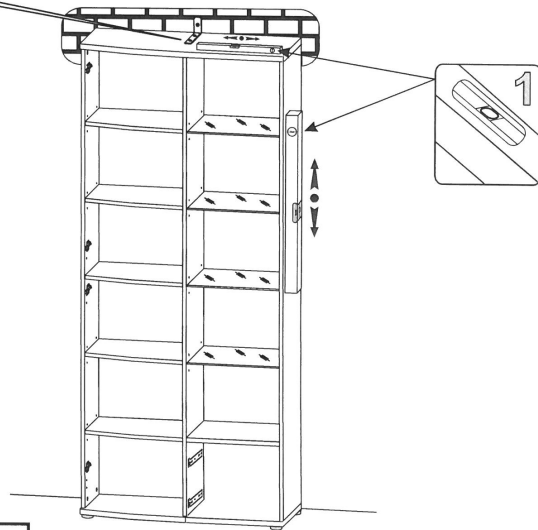
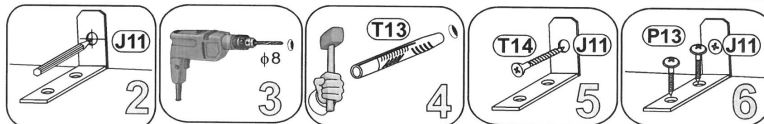
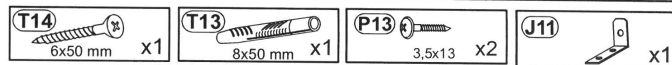



10

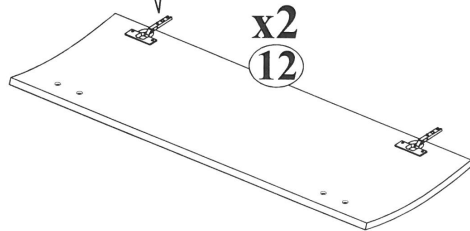
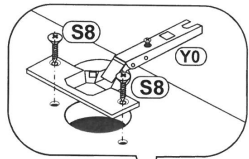
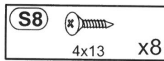
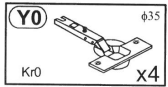

11

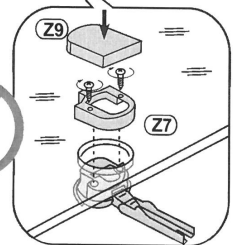
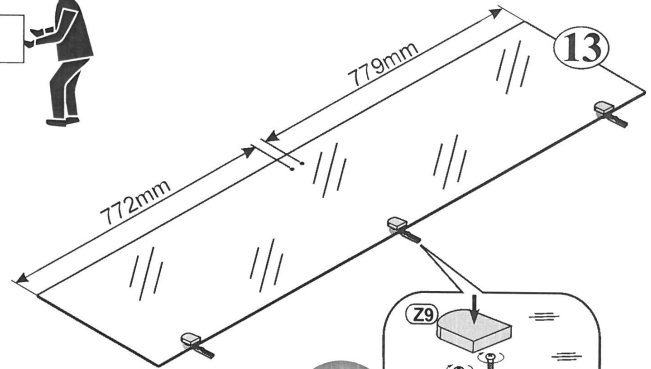
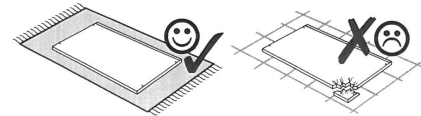
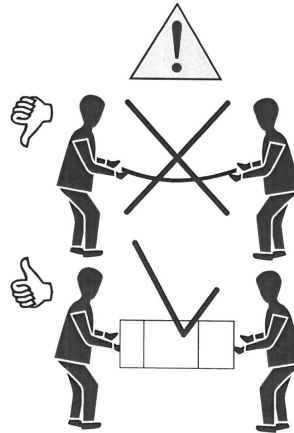
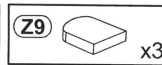

MALTA

6X--MA80

Type:02

10 / 13

12

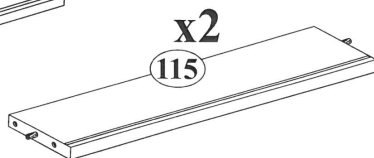
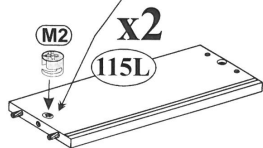
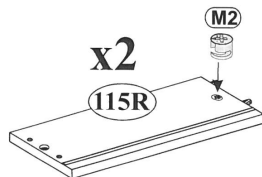
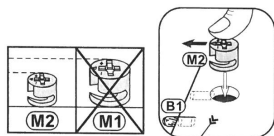
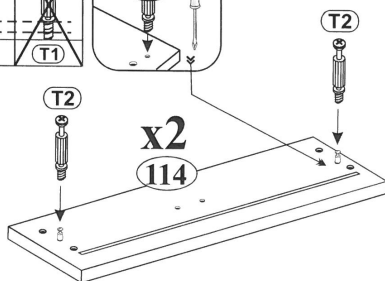
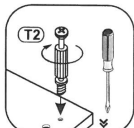
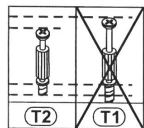
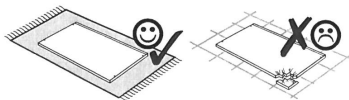
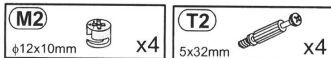

13

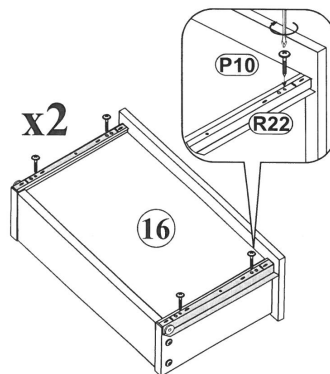
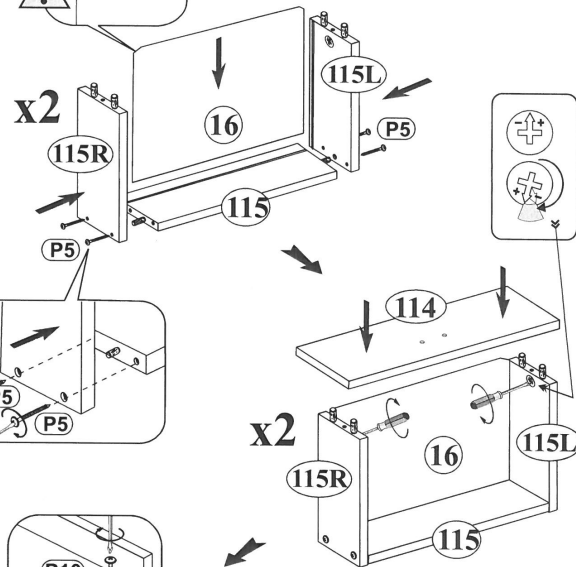
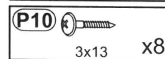
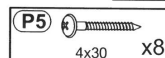
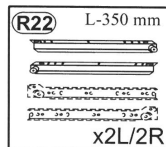

MALTA

6X--MA80

Type:02

11 / 13

14

U173



x2

A2



M4x25

x4

C17



1,5mm

x4

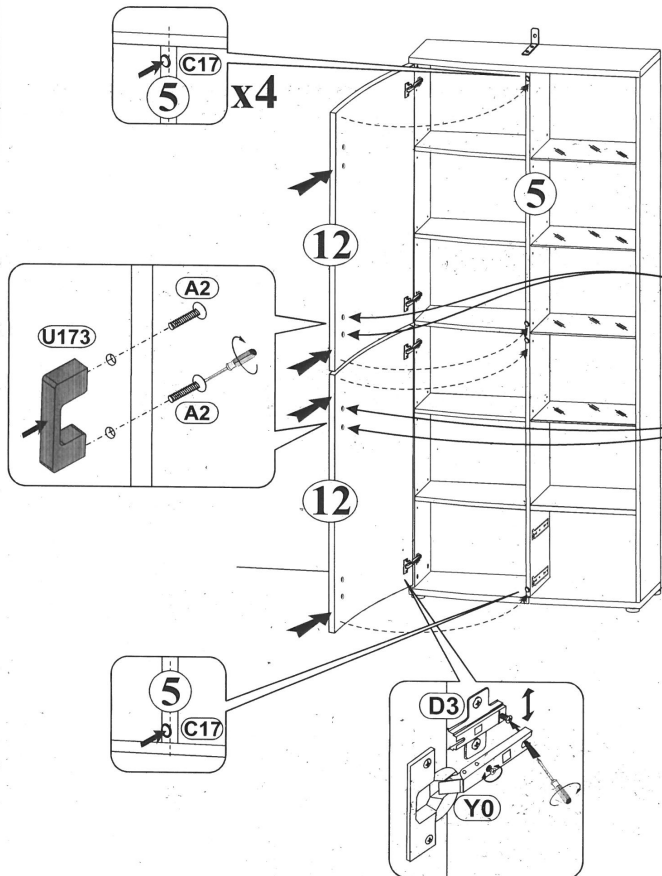

15

U173



x1

G4



x2

C17



1,5mm

x2

A3



M4x16

x2

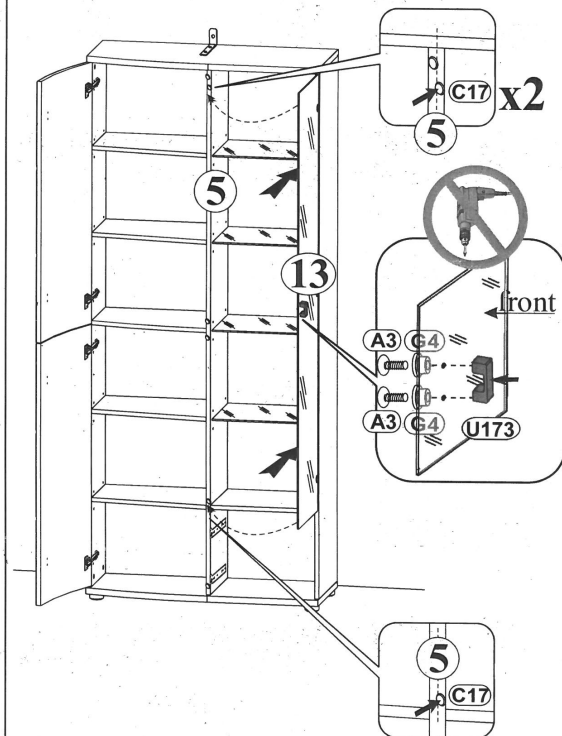

16

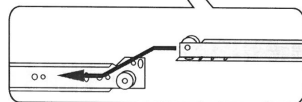
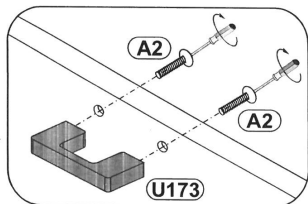
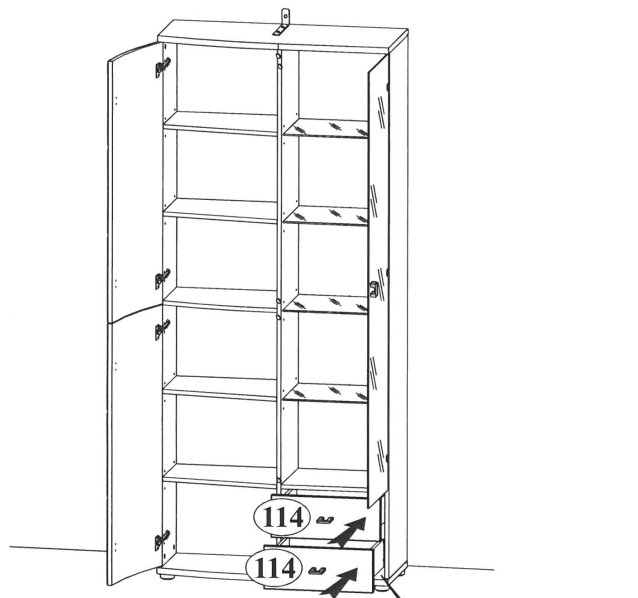

17

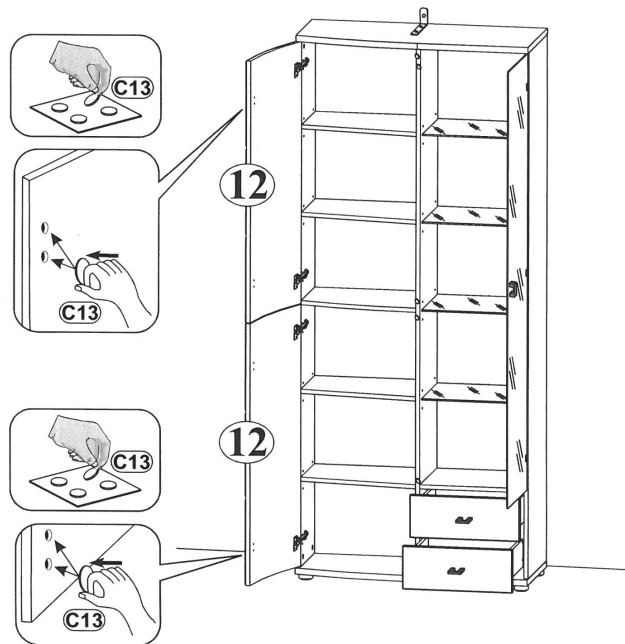
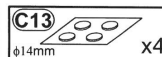
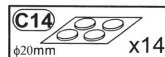

18

