







## KIRSTEN IV 2F.URCBK/URCBK.2F

 A	x 6	 A1	x 6	 A2	x 8	 A3	x 4	 A4	x 7
---------------------------------------------------------------------------------------	-----	----------------------------------------------------------------------------------------	-----	----------------------------------------------------------------------------------------	-----	----------------------------------------------------------------------------------------	-----	----------------------------------------------------------------------------------------	-----

WW1  
M6x50

WS M6x20

US 5x30

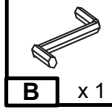

x 1

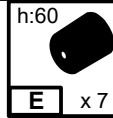

h:60

x 7

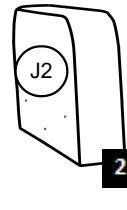
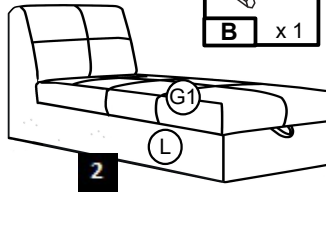
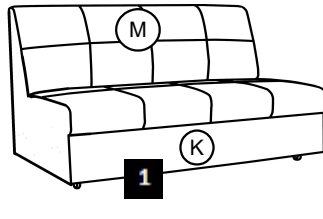
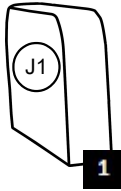

## 2F.URCBK

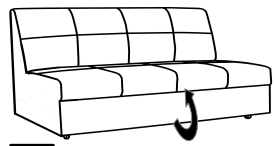

2

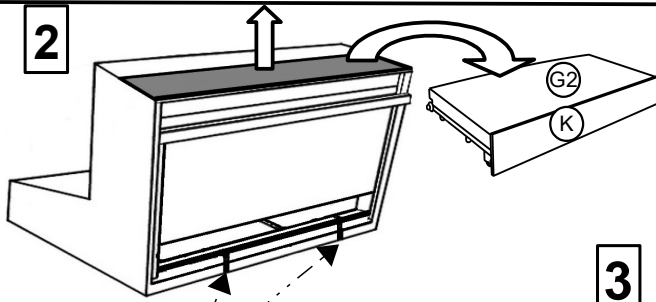

1

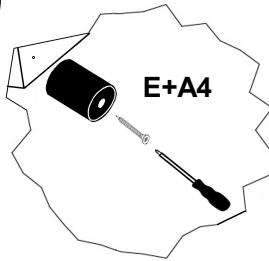
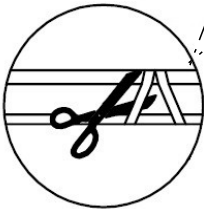

E+A4

3

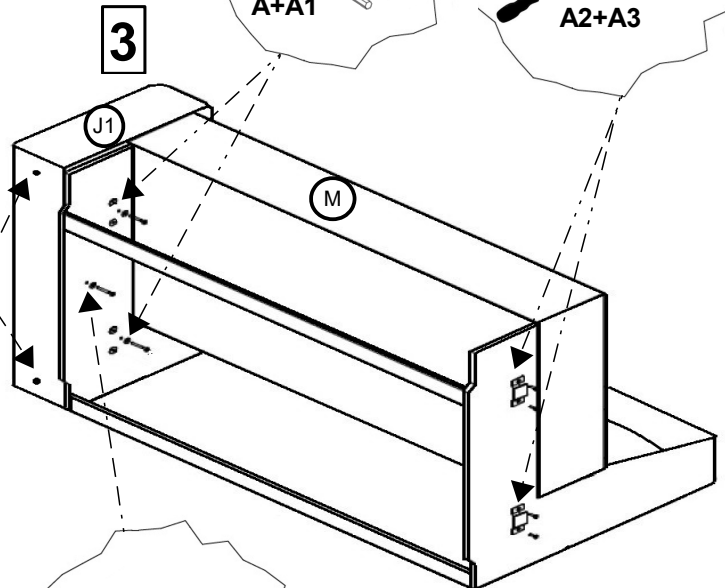

A+A1

A2+A3

4

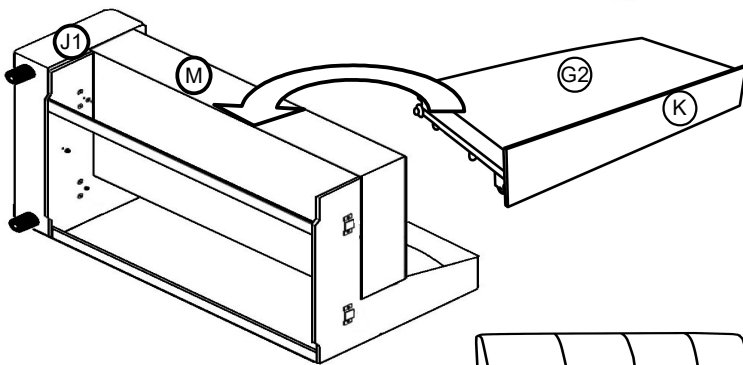

A+A1

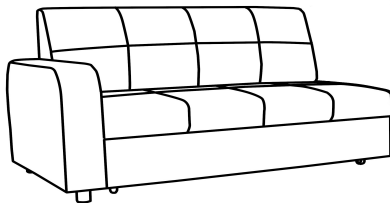

A	G2
A1	J1
A2	J2
A3	K
A4	L
E	M
G1	

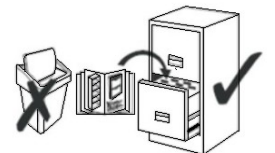

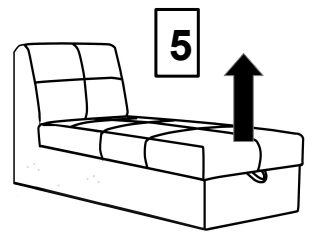

5

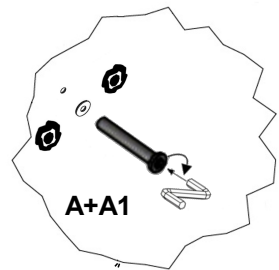

A+A1

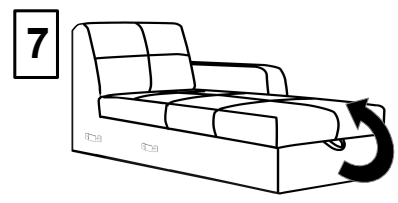

7

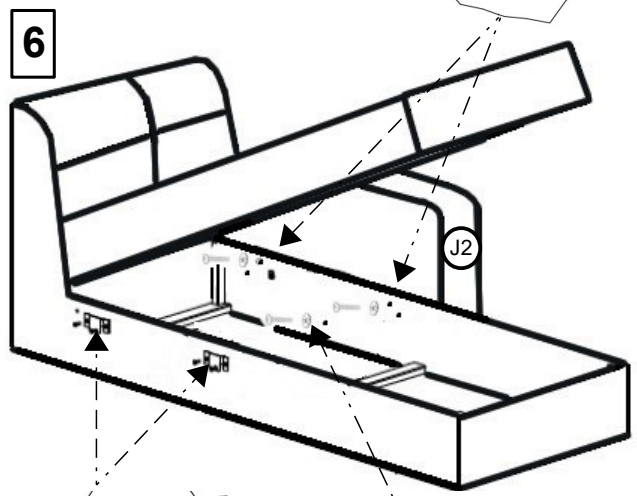

6

A2+A3



E+A4

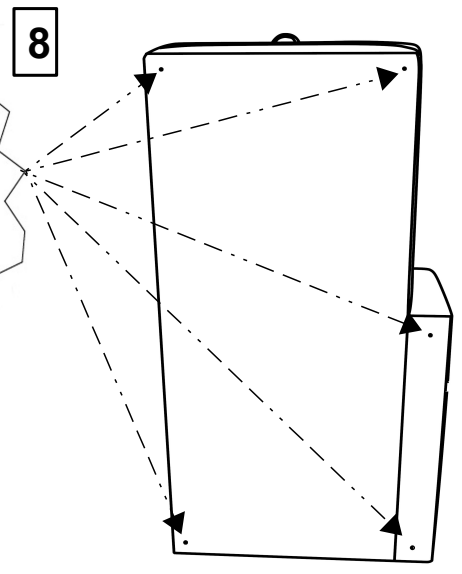

8

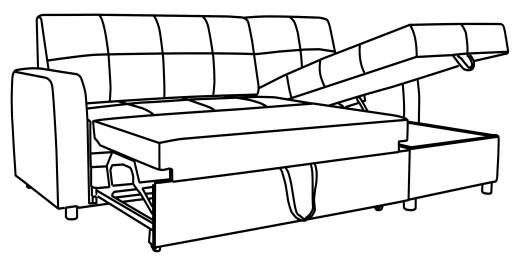
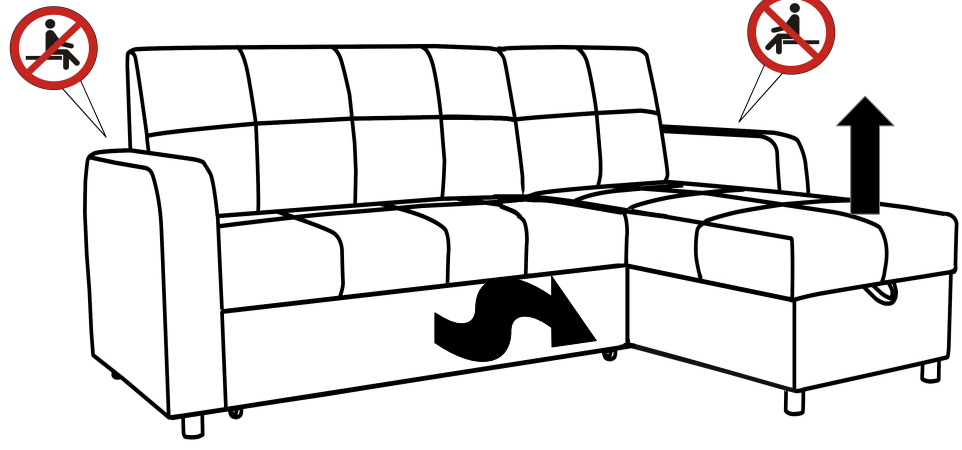
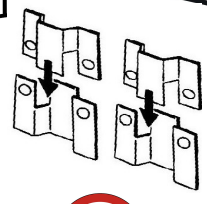
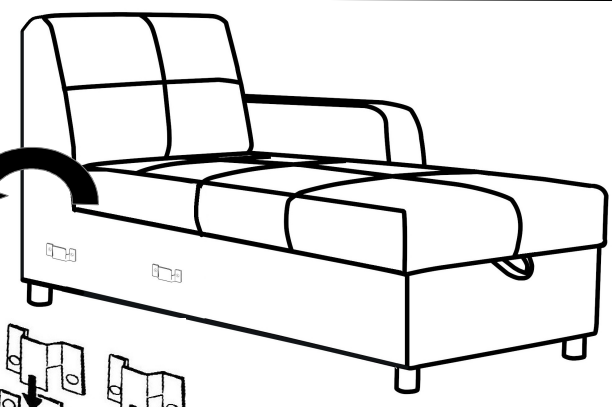
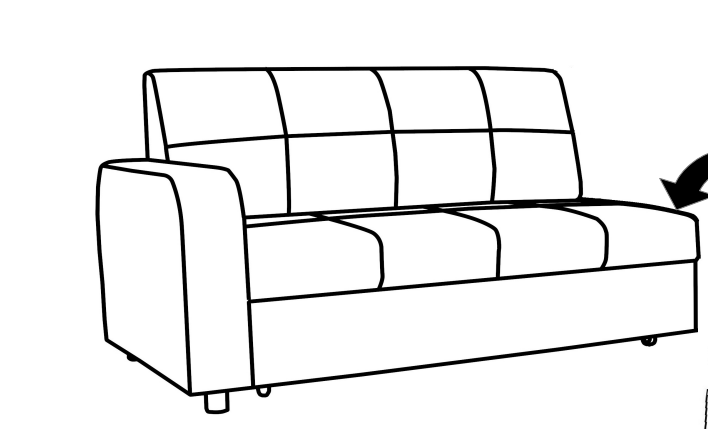
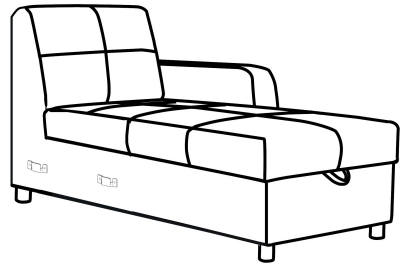

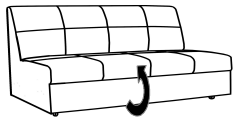
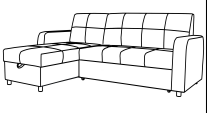

1

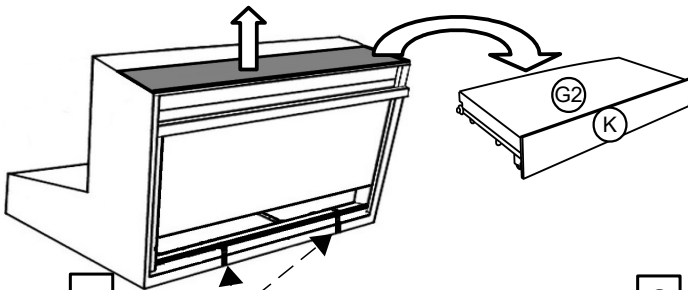

2

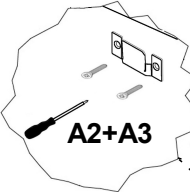
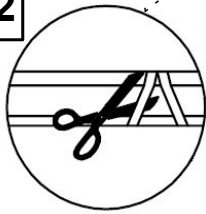
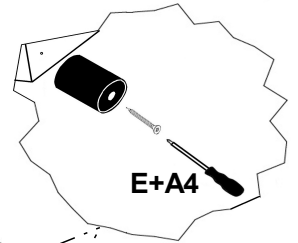
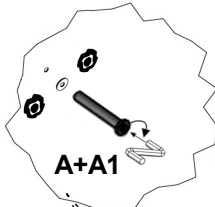

3

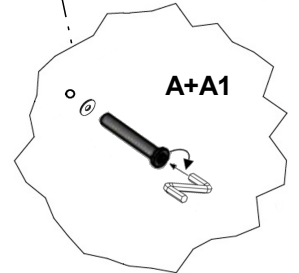
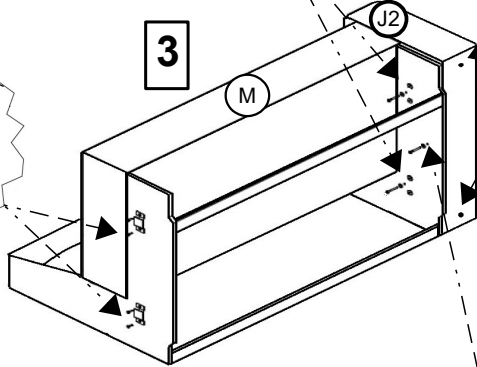

4

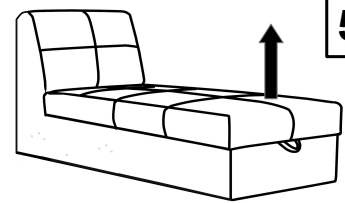
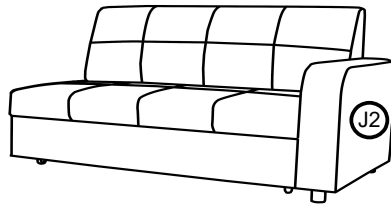
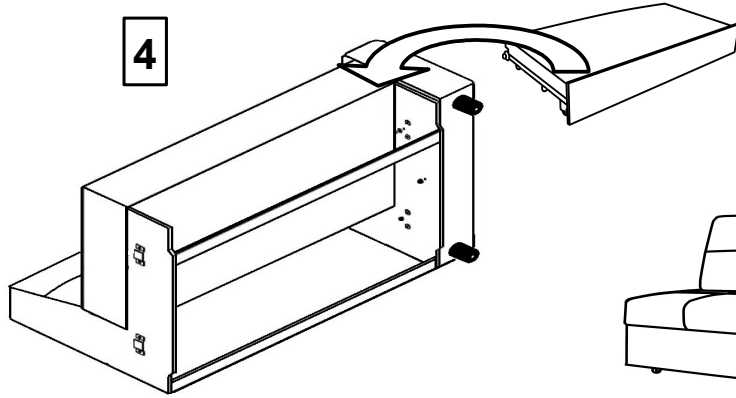

5

6

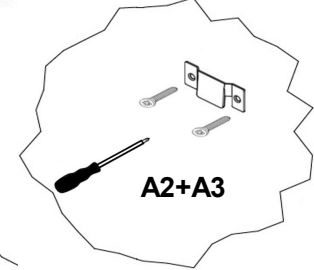
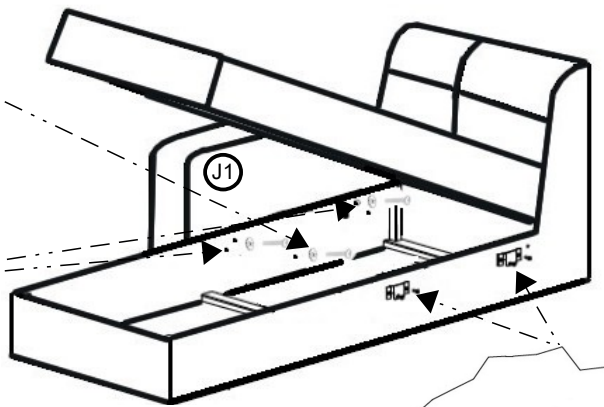
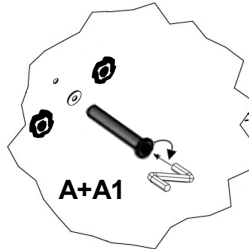
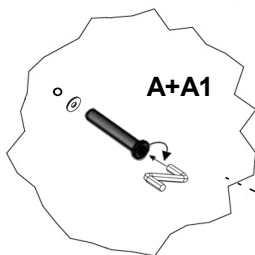

7

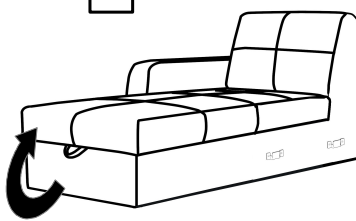

8

