









GAME LUX 2DL.REC

 A x 4	 A1 x 8	 A2 x 3	 A3 x 3	 A4 x 4	 A5 x 15	 B x 3
---	--	--	--	--	---	---

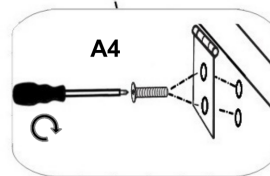
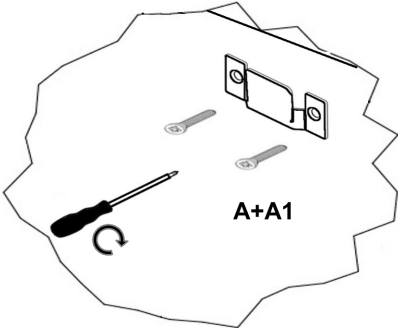
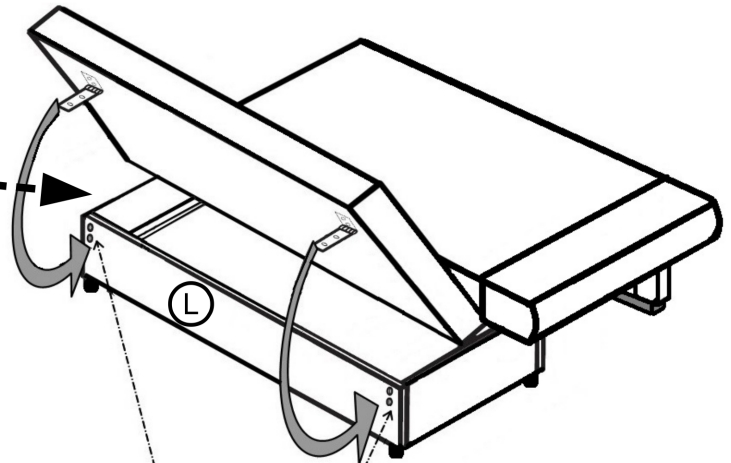
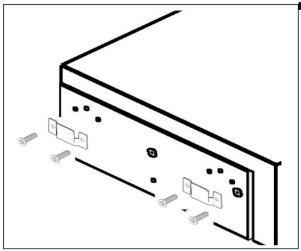
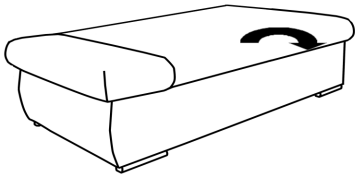
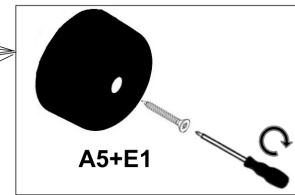
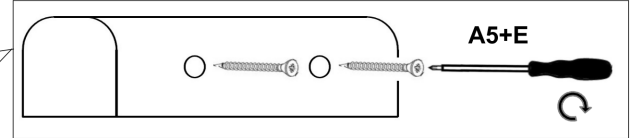
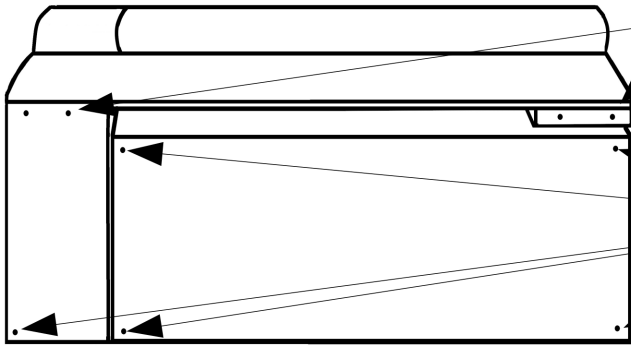
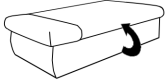
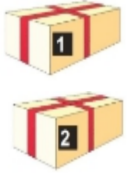
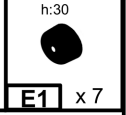
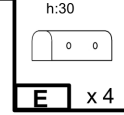
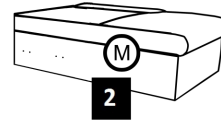
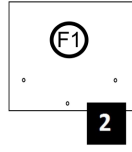
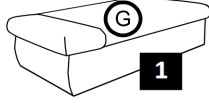
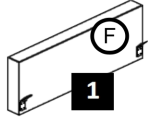

A	E	L
A1	E1	M
A2	F	
A3	F1	
A4	G	
A5	K	
B	K1	

